

House of Troy

Scatchard Stoneware™



2018



A craftsman wearing a green t-shirt and a dark baseball cap is working on a lathe in a workshop. The scene is dimly lit, with a warm, glowing lamp hanging from the ceiling. The craftsman is focused on his work, with his hands positioned on the lathe's controls. The background shows various tools and equipment, creating a sense of a busy, traditional workshop.

House of Troy

Tucked into the northern Vermont hills, just down the road from the picturesque ski village of Stowe, House of Troy has been producing classic lighting since the mid 1940's. Though off the beaten path and far from the spotlights of the big cities, our reputation burns brightly. For nearly seventy years, House of Troy has offered lighting known for its craftsmanship and quality.

We began as metal workers, making products to illuminate fine art work. Over the years we expanded our line to include floor lamps, table lamps and wall lamps. We design our products around a light source creating fine task lamps which suit a need.

In 2013 we purchased Scatchard Stoneware and opened our pottery in Hyde Park Vermont. Using a high fire reduction process and proprietary glazes, we now offer decorative lamps with beautiful deep finishes that will stand the test of time.

Table of Contents



Picture Lights:
Plug-In
page 4



Picture Lights:
Direct Wire
page 30



Picture Lights:
Battery Operated
page 62

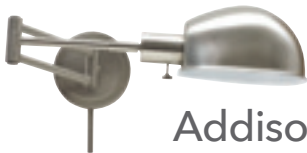

Addison
page 70



Averill
page 74



Bennington
page 76



Burke
page 82



Cavendish
page 84



Club
page 87



Coach
page 94



Crown Point
page 99



Danby
page 102



Delta
page 106



Essex
page 110



Fairfax
page 117



Franklin
page 119

Table of Contents



Generation 1
page 123



Generation 2
page 127



Generation 3
page 130

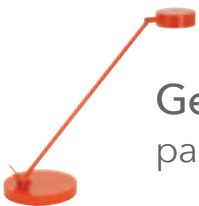

Generation 4
page 134

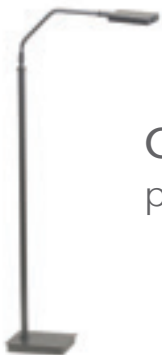

Generation 5
page 141



Geo Mini
page 145



Hardwick
page 150



Home Office
page 155

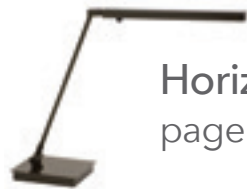

Horizon
page 169



Hyde Park
page 172



Ira
page 179



Jay
page 183



Kirby
page 185



Lancaster
page 191



Lewis
page 194



Morgan
page 196

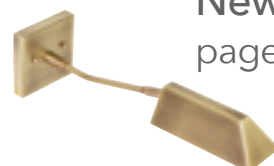

Newbury
page 201

Table of Contents



Newport
page 204



Otis
page 213



Pinnacle
page 217



Richmond
page 221



Rupert
page 224



Somerset
page 231



Town House
page 235



Tripod
page 241



Vergennes
page 243



Windsor
page 245



Wall Sconces
page 247



Wall Swing Arms
page 262

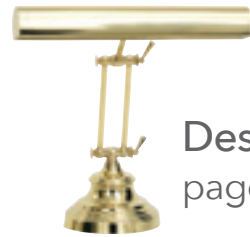

Desk/Piano
page 301



Specialty Piano
page 322



Specialty Task
page 344



Scatchard Stoneware
page 346

Stoneware Glazes. 348

Finishes. 390

Custom Direct Mount . . . 67

Q&A. 392

Index 393

Picture Lights – Plug-In



Plug-In picture lights work best when you have easy access to an outlet. They come with an 8' ivory cord equipped with a high-low roll switch conveniently located 3' from the plug end. If you are planning construction, have your contractor install recessed outlets behind the art work and remotely switch on the wall with a dimmer system.

Plug-In Options

Incandescent

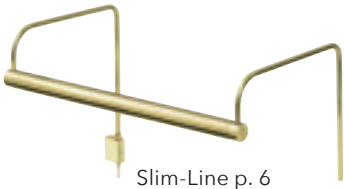

Slim-Line p. 6



Slim-Line XL p. 8



Traditional p. 20



Contemporary p. 22

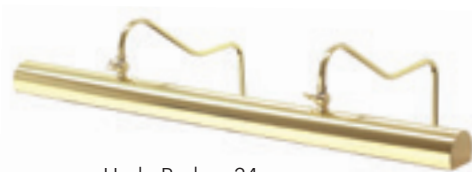

Hyde Park p. 24



Richardson Reflector p. 25



Advent Profile p. 28



Advent Standard p. 29

LED



Slim-Line LED p. 10



Ultra Slim-Line LED p. 12



Horizon LED p. 14



Zenith LED p. 16

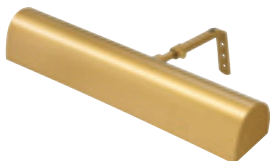

Traditional LED p. 18



Advent Gemini LED p. 26



Advent Profile LED p. 27

Plug-In Slim-Line™ Incandescent



Tim Cuppett Architecture + Interiors

SL64-91 (Oil Rubbed Bronze) shown

Finishes



Plug-In Slim-Line™ Incandescent



SL16-61 (Polished Brass)

Features

- Shade rotates to adjust light
- Tilt socket allows for easy bulb replacement
- Pebbled aluminum reflector provides maximum light output
- Paintable 8' ivory cord with In-line hi-lo switch 3' from plug
- Mount to frame or wall with included hardware
- Customization available upon request
- Optional LED bulbs available (LED 2.3W)

Size Selection Guide

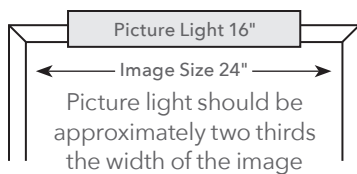

Specifications

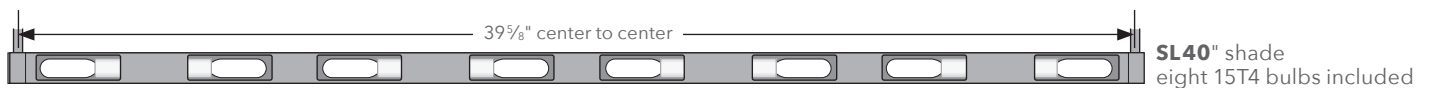
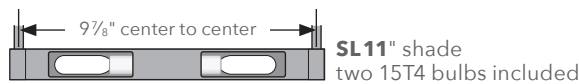

Non stocked lamps available with three arms in 64" and 84" lengths.

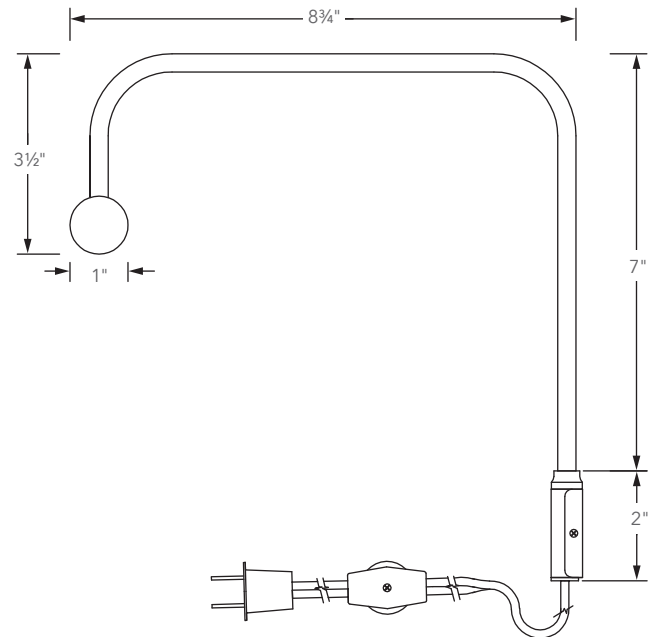

Plug-In Slim-Line™ XL Incandescent



XL14-91 (Oil Rubbed Bronze) shown

Finishes

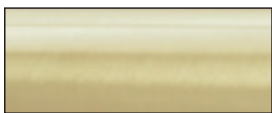

Satin Brass #51

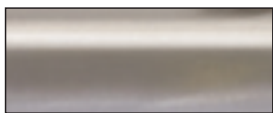

Satin Nickel #52



Polished Brass #61

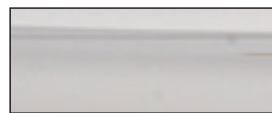

Chrome #62

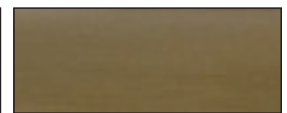

Antique Brass #71



Oil Rubbed Bronze #91

Plug-In Slim-Line™ XL Incandescent



XL36-52 (Satin Nickel)

Features

- Shade rotates to adjust light
- Tilt socket allows for easy bulb replacement
- Pebbled aluminum reflector provides maximum light output
- Paintable 8' ivory cord with In-line hi-lo switch 3' from plug
- Mount to frame or wall with included hardware
- Customization available upon request
- Optional LED bulbs available (LED 2.5W)

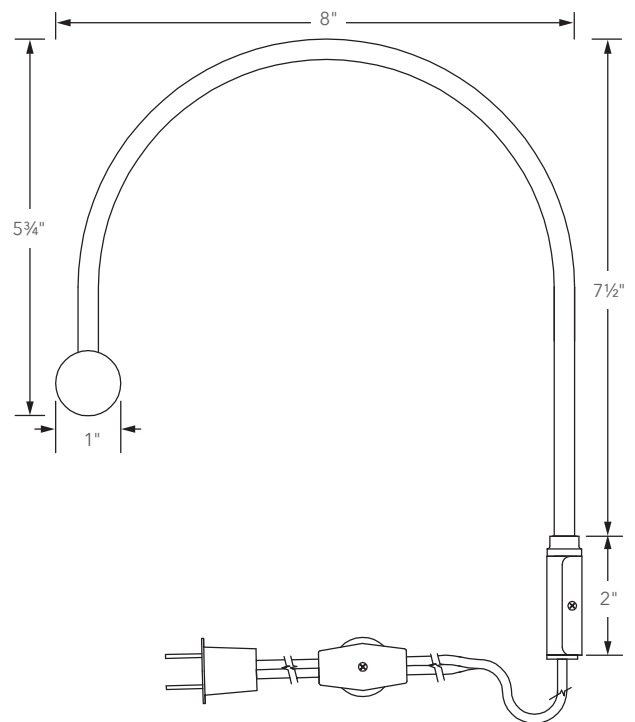

Size Selection Guide

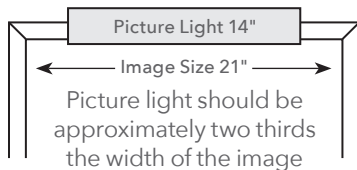

Specifications

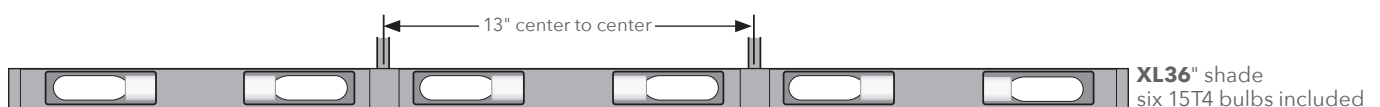

Plug-In Slim-Line™ LED



SLEDZ29-91 (Oil Rubbed Bronze) shown

Finishes

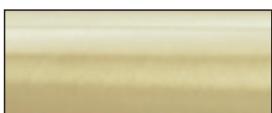

Satin Brass #51



Satin Nickel #52



Polished Brass #61

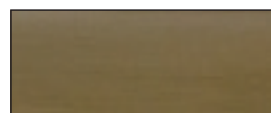

Antique Brass #71



Oil Rubbed Bronze #91

Plug-In Slim-Line™ LED



SLEDZ43-52 (Satin Nickel)

Features

- No damaging UV
- Line Voltage
- Dimmable to 5% with triac dimmer
- Diffused for even light spread
- 50,000 hour lifetime
- Five year warranty on LED array
- Shade rotates to adjust light
- Paintable 8' ivory cord with In-line switch 3' from plug
- Mount to frame or wall with included hardware
- Customization available upon request

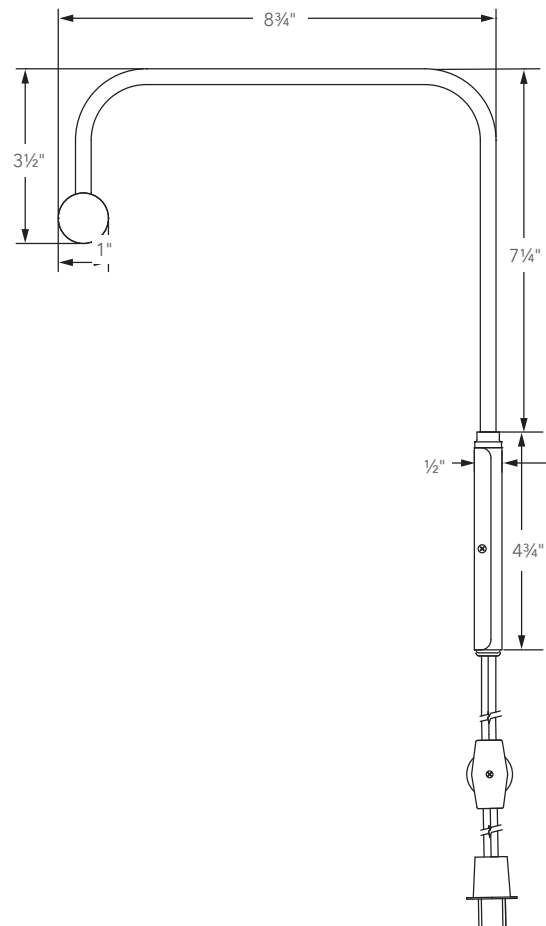

Size Selection Guide

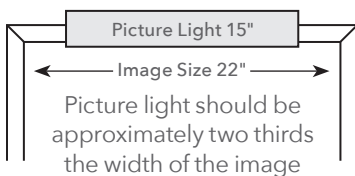

Specifications

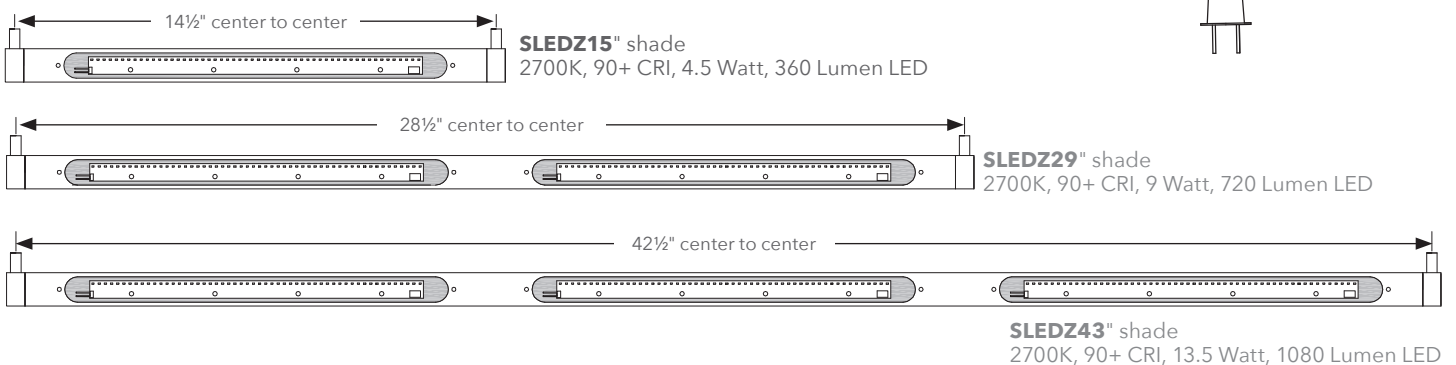

Plug-In Ultra Slim-Line™ LED



USLEDZ15-7 (Black) shown

Finishes

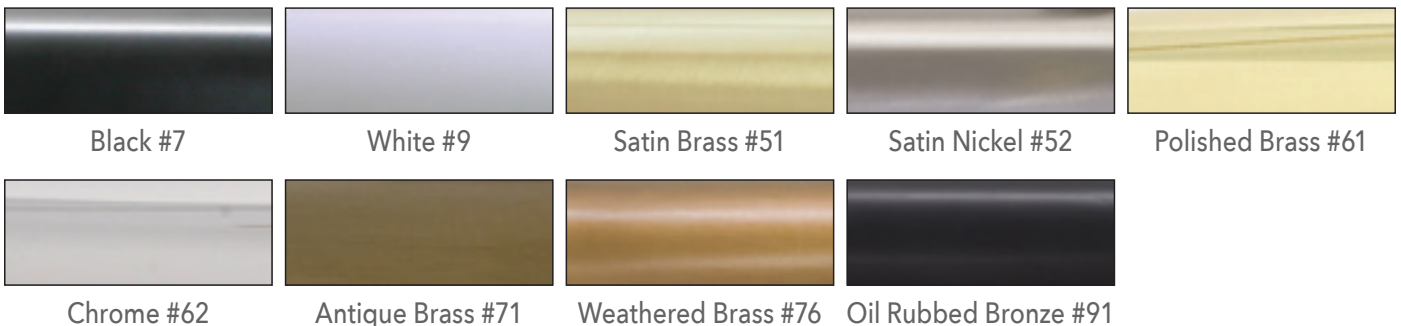

Plug-In Ultra Slim-Line™ LED

USLEDZ28-52 (Satin Nickel)

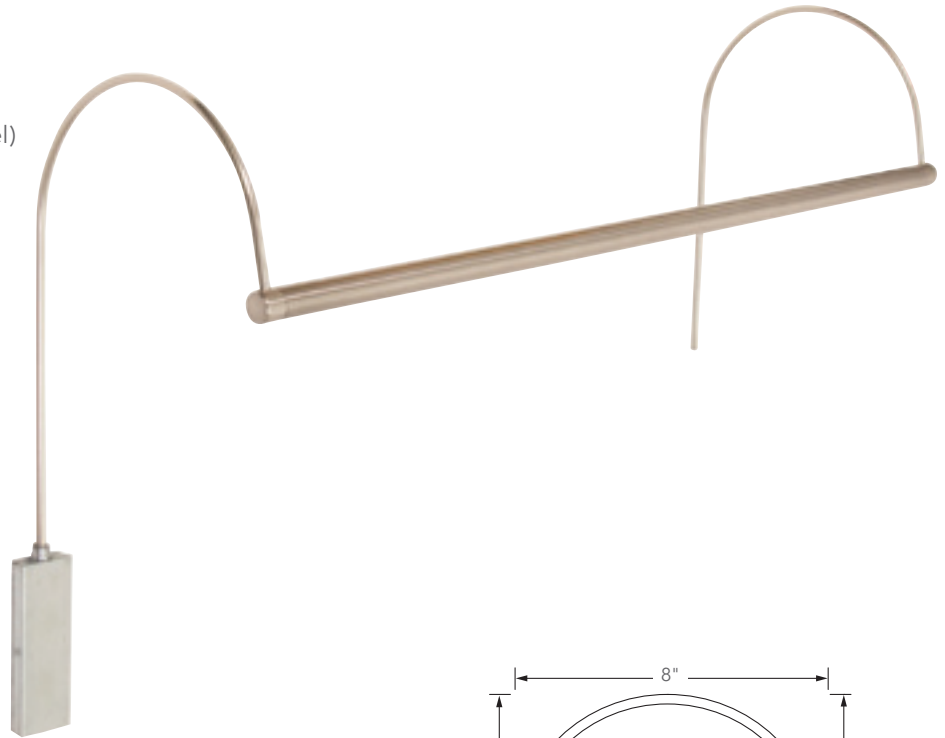

Features

- No damaging UV
- Line Voltage
- Dimmable to 5% with triac dimmer
- Diffused for even light spread
- 50,000 hour lifetime
- Five year warranty on LED array
- Shade rotates to adjust light
- Paintable 8' ivory cord with In-line switch 3' from plug
- Mount to frame or wall with included hardware
- Customization available upon request

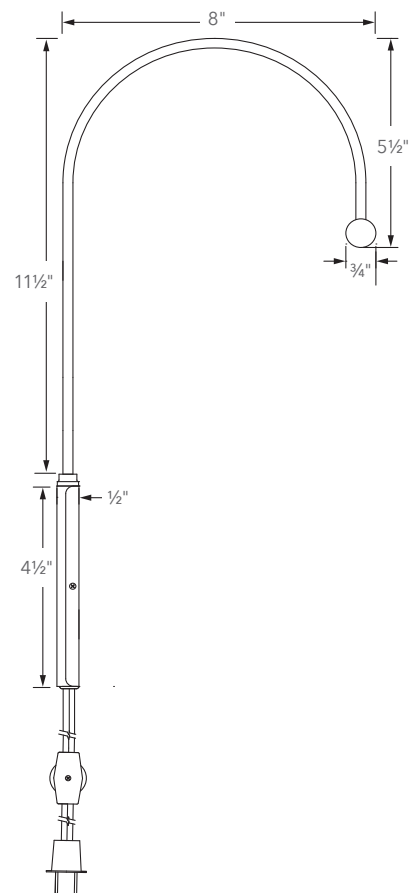

Size Selection Guide

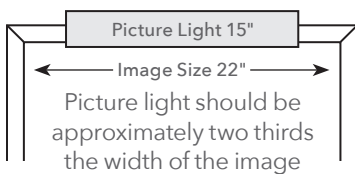

Specifications

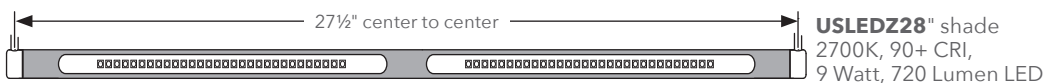
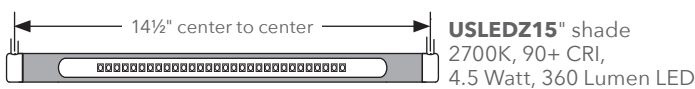

Plug-In Horizon LED



HLEDZ12-62 (Chrome) shown

Finishes

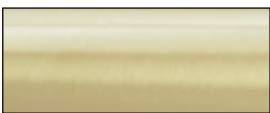

Satin Brass #51

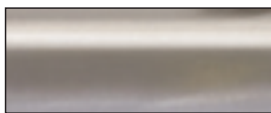

Satin Nickel #52

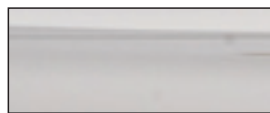

Chrome #62

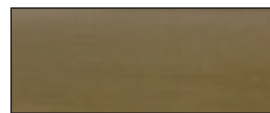

Antique Brass #71

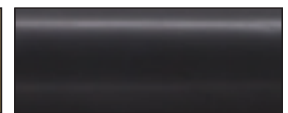

Oil Rubbed Bronze #91

Plug-In Horizon LED



HLEDZ26-51 (Satin Brass)

Features

- No damaging UV
- Line Voltage
- Dimmable to 5% with triac dimmer
- Diffused for even light spread
- 50,000 hour lifetime
- Five year warranty on LED array
- Swivel at shade for easy shade positioning
- Paintable 8' ivory cord with In-line switch 3' from plug
- Mount to frame or wall with included hardware
- Customization available upon request

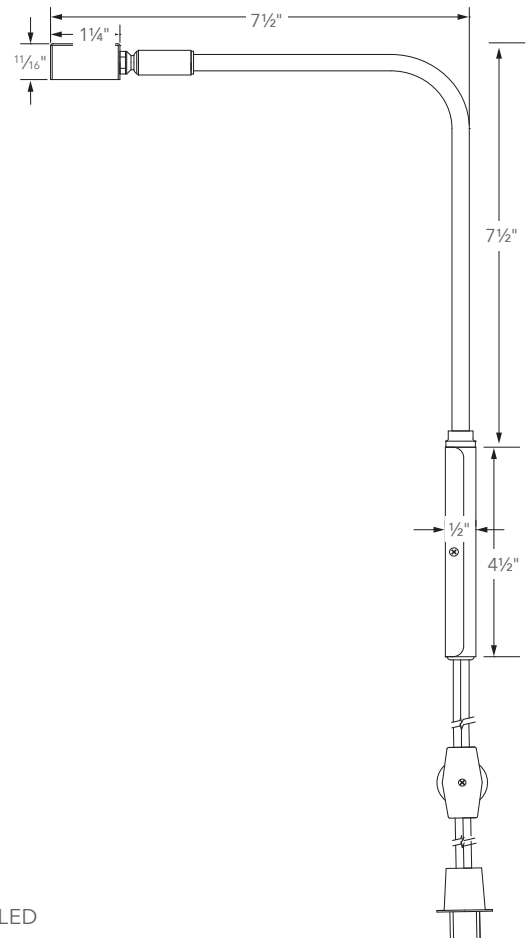

Size Selection Guide

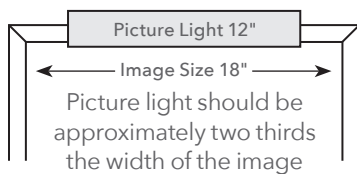

Specifications

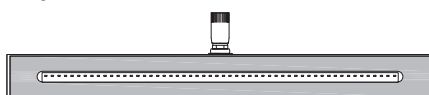

HLEDZ12" shade
2700K, 90+ CRI, 4.5 Watt, 360 Lumen LED

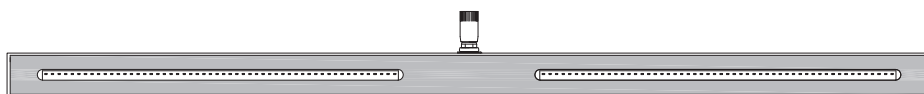

HLEDZ26" shade
2700K, 90+ CRI, 9 Watt, 720 Lumen LED

Plug-In Zenith LED



ZLED12-52 (Satin Nickel) shown

Finishes

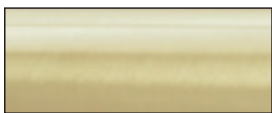

Satin Brass #51

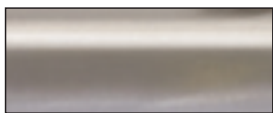

Satin Nickel #52

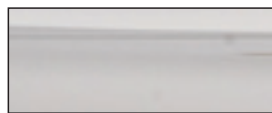

Chrome #62

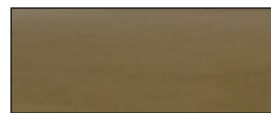

Antique Brass #71



Oil Rubbed Bronze #91

Plug-In Zenith LED



ZLEDZ36-62 (Chrome)

Features

- No damaging UV
- Line Voltage
- Dimmable to 5% with triac dimmer
- Diffused for even light spread
- 50,000 hour lifetime
- Five year warranty on LED array
- Swivel at shade for easy shade positioning
- Paintable 8' ivory cord with In-line switch 3' from plug
- Mount to frame or wall with included hardware
- Customization available upon request

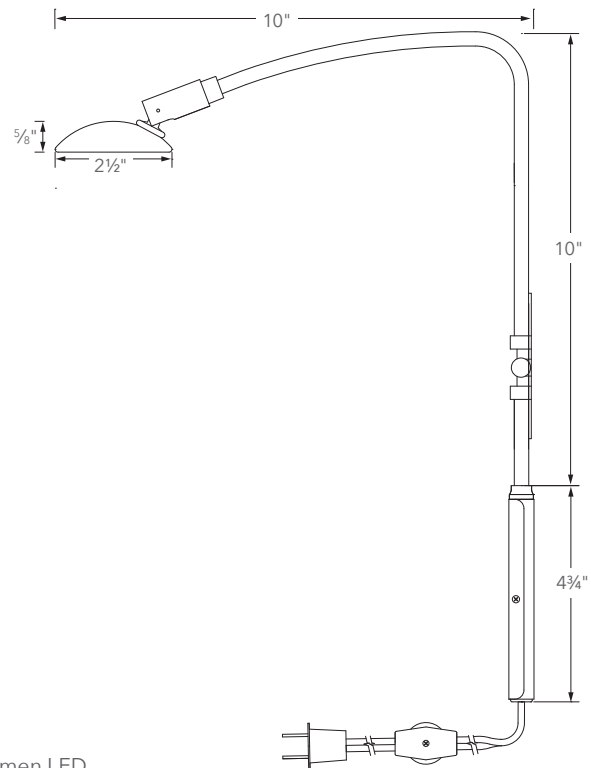

Size Selection Guide

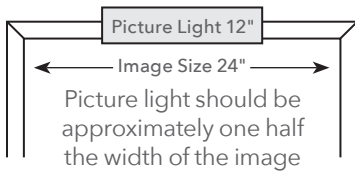

Specifications

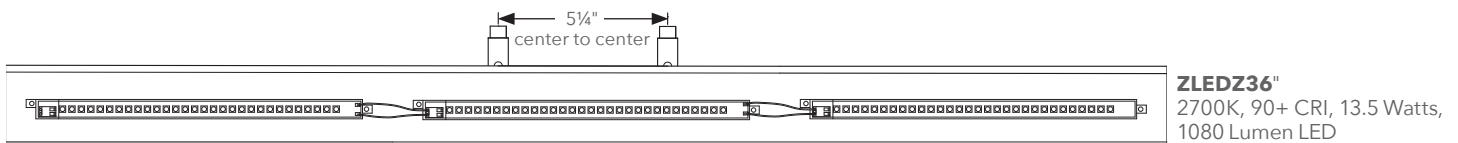
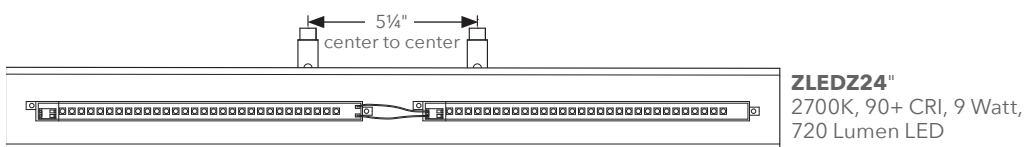

Plug-In Traditional LED



TLEDZ14-71 (Antique Brass) shown

Finishes



Gold #1



Bronze #5



Pewter #31



Satin Brass #51

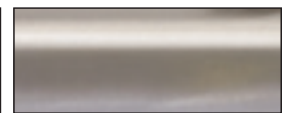

Satin Nickel #52



Statuary Bronze #56

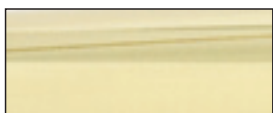

Polished Brass #61

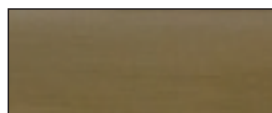

Antique Brass #71



Weathered Brass #76



Mahogany Bronze #81

Plug-In Traditional LED



TLEDZ14-1 (Gold)

Features

- No damaging UV
- Line Voltage
- Dimmable to 5% with triac dimmer
- Diffused for even light spread
- 50,000 hour lifetime
- Five year warranty on LED array
- Swivel at shade for easy shade positioning
- Slide arm adjusts for horizontal extension
- Paintable 8' ivory cord with In-line switch 3' from plug
- Mount to frame or wall with included hardware
- Customization available upon request

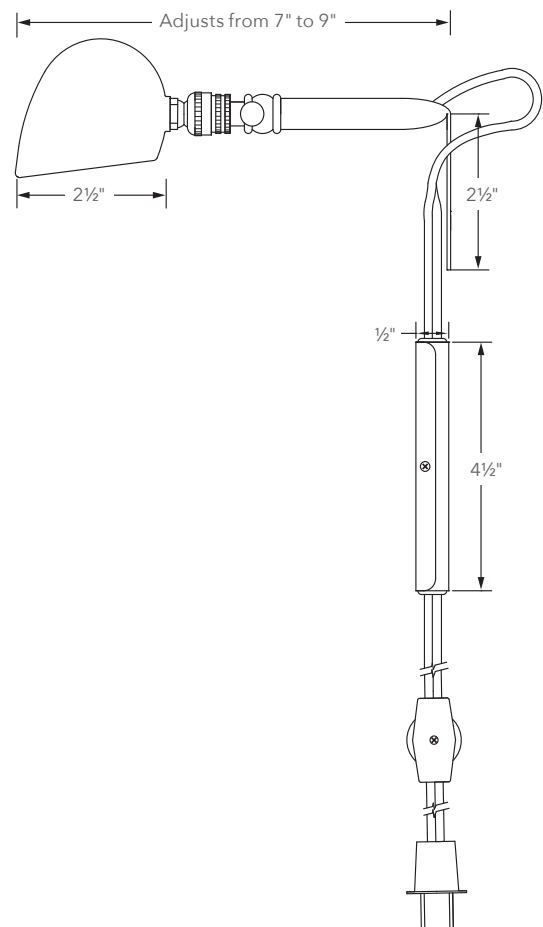

Size Selection Guide

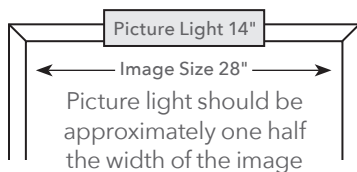

Specifications

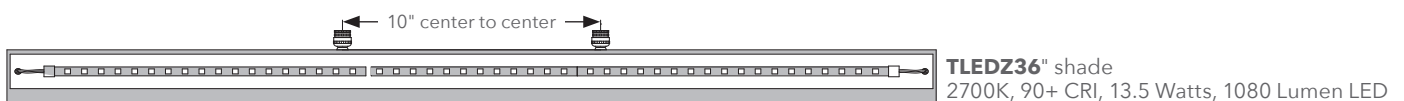
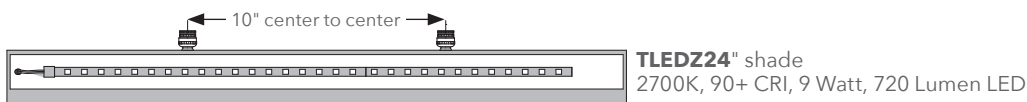

Plug-In Traditional Incandescent

T36-52 (Satin Nickel)



Accent options available in 8", 14", 24", & 36" lengths



TB14-SN/PN



TR14-AB/PB



TS14-BLK/PN

T24-51 (Satin Brass)

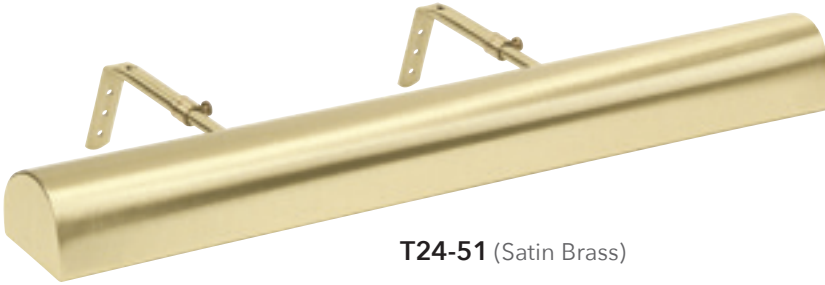

T8-1 (Gold)



Standard Finishes



Gold #1

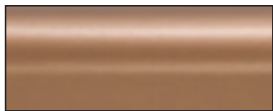

Bronze #5



Pewter #31

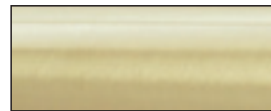

Satin Brass #51



Satin Nickel #52



Statuary Bronze #56

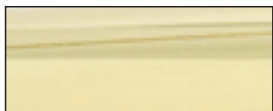

Polished Brass #61

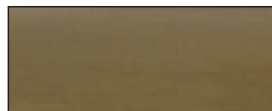

Antique Brass #71



Weathered Brass #76



Mahogany Bronze #81

Accent Finish Combinations

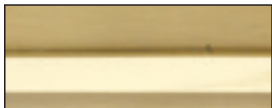

Antique Brass and Polished Brass
AB/PB

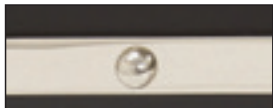

Black and Polished Nickel
BLK/PN

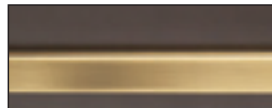

Mahogany Bronze and Antique Brass
MB/AB

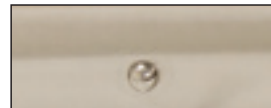

Satin Nickel and Polished Nickel
SN/PN

Plug-In Traditional Incandescent

Features

- Swivel at shade for easy shade positioning
- Slide arm adjusts for horizontal extension
- Paintable 8' ivory cord with In-line hi-lo switch 3' from plug
- Polished metal reflector in shade for maximum light output
- Mount to frame or wall with included hardware
- Customization available upon request

Size Selection Guide

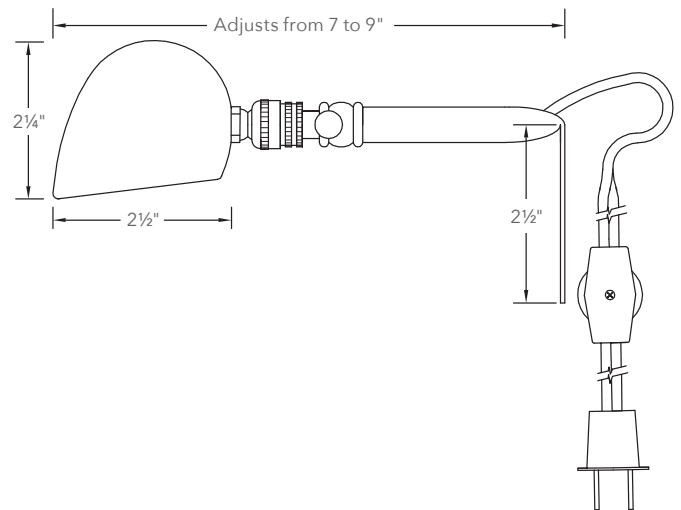
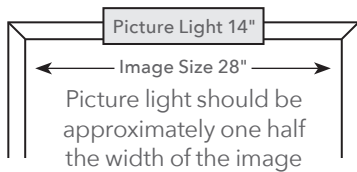

Specifications

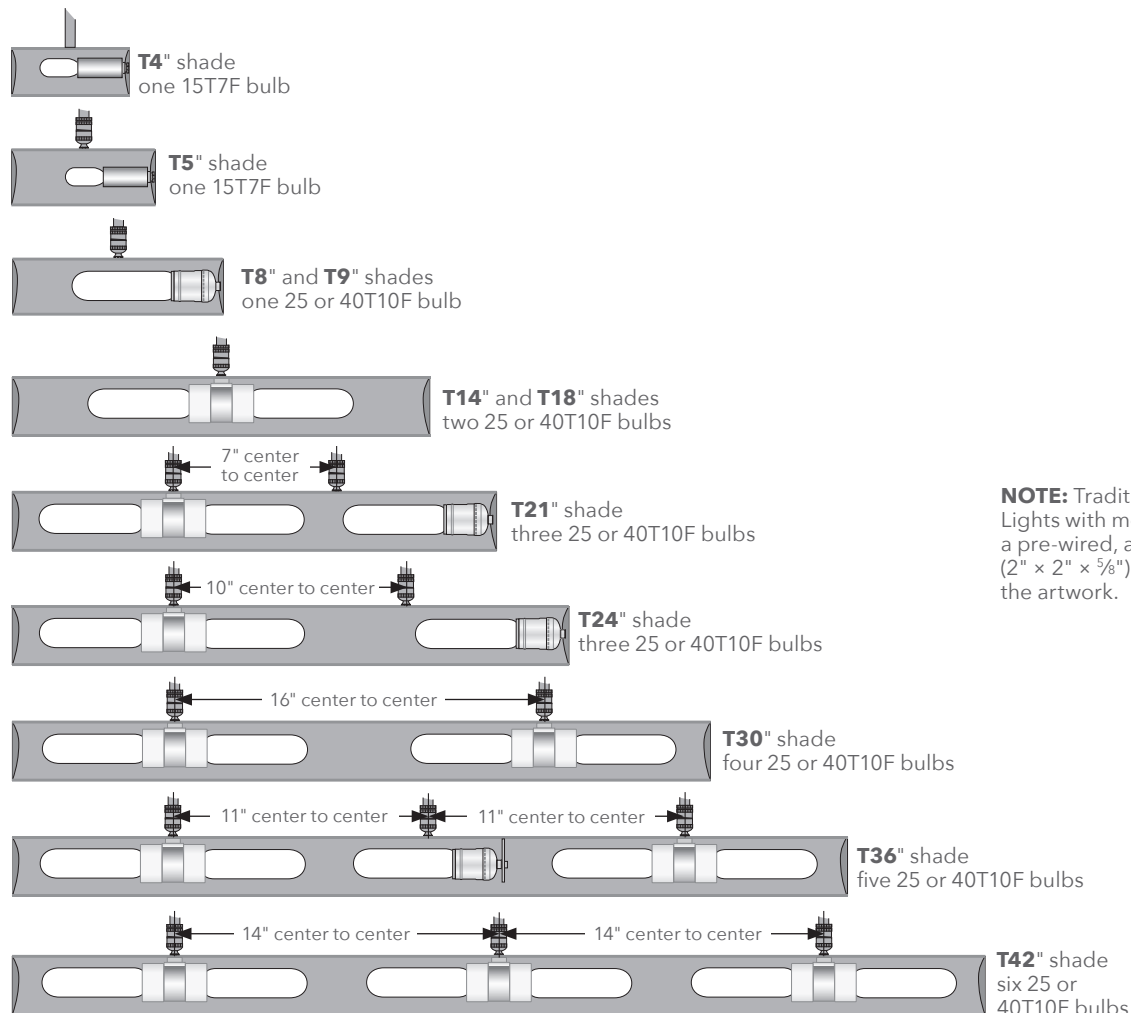

NOTE: Traditional Series Picture Lights with more than one arm, have a pre-wired, aluminum splice-box (2" x 2" x 5/8") which hangs behind the artwork.

Plug-In Contemporary Incandescent



C9-52 (Satin Nickel) shown

Finishes



Gold #1

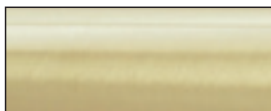

Satin Brass #51



Satin Nickel #52



Polished Brass #61

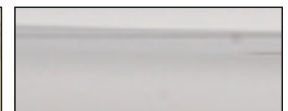

Chrome #62

Plug-In Contemporary Incandescent



C24-51 (Satin Brass)

Features

- Swivel at shade for easy shade positioning
- Slide arm adjusts for horizontal extension
- Paintable 8' ivory cord with In-line hi-lo switch 3' from plug
- Polished metal reflector in shade for maximum light output
- Mount to frame or wall with included hardware
- Customization available upon request

Size Selection Guide

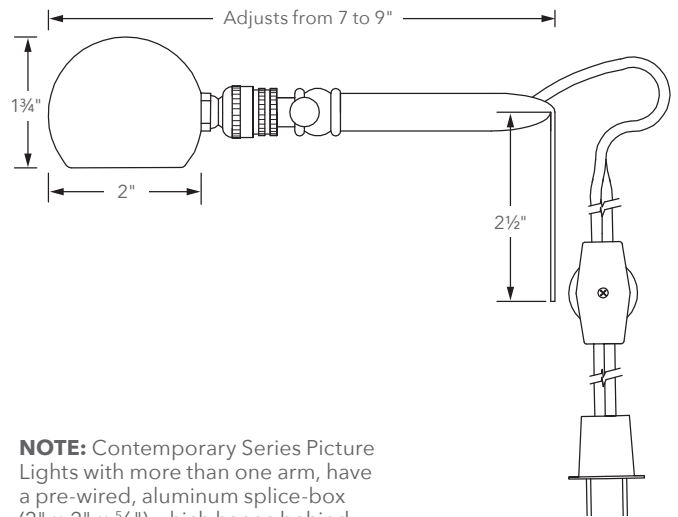
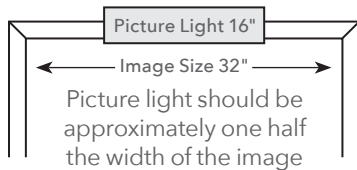

Specifications

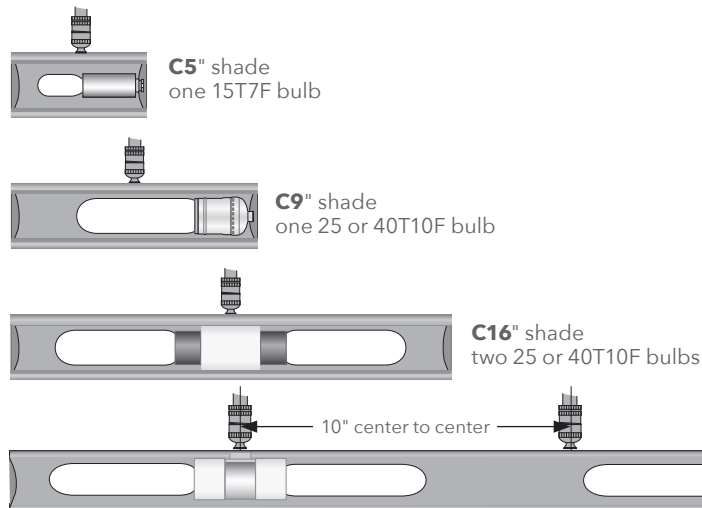

NOTE: Contemporary Series Picture Lights with more than one arm, have a pre-wired, aluminum splice-box (2" x 2" x 5/8") which hangs behind the artwork.

Plug-In Hyde Park Incandescent



HP30-61 (Polished Brass)

Features

- Swivel at shade for easy shade positioning
- Paintable 8' ivory cord with In-line hi-lo switch 3' from plug
- Polished metal reflector in shade for maximum light output
- Mount to frame or wall with included hardware
- Customization available upon request

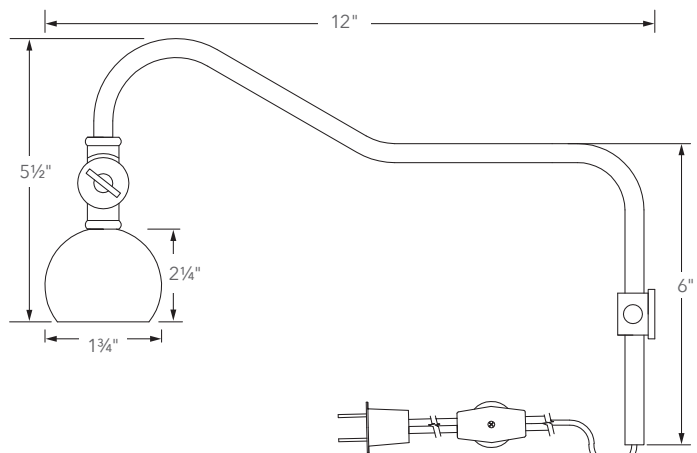

Note: Hyde Park Series Picture Lights with more than one arm, have a pre-wired, aluminum splice-box (2"×2"×5/8") which hangs behind the artwork.

Size Selection Guide

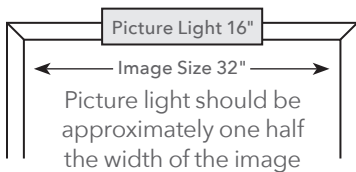

Specifications

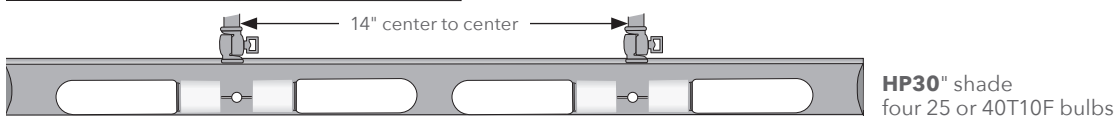
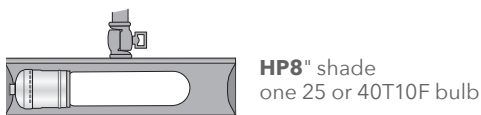

Finishes

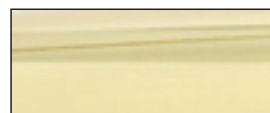

Polished Brass #61

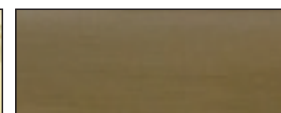

Antique Brass #71



Weathered Brass #76



Oil Rubbed Bronze #91

Plug-In Richardson Incandescent

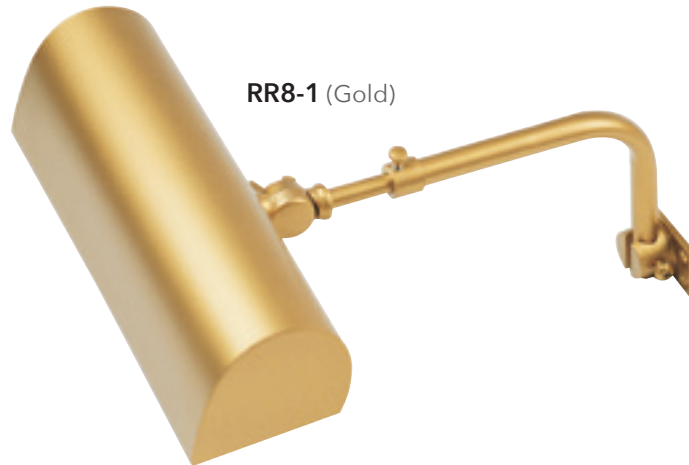

RR8-1 (Gold)

Features

- Swivel at shade for easy shade positioning
- Slide arm adjusts for horizontal extension
- Paintable 8' ivory cord
- Polished metal reflector in shade for maximum light output
- Mount to frame or wall with included hardware
- Customization available upon request

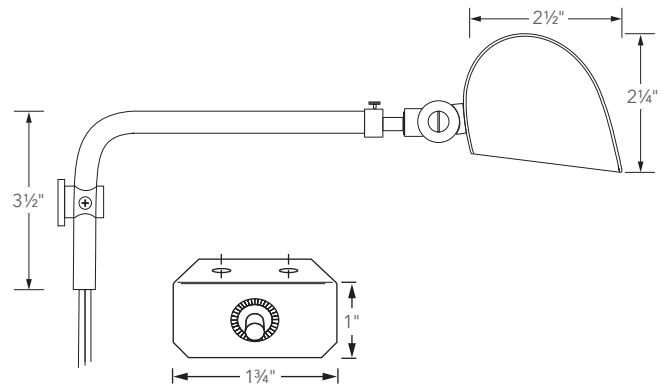

Optional: Richardson
FRAME SWITCH (FRSW)

Type "D" Switch, attaches to back of frame (switch sold separately).

Size Selection Guide

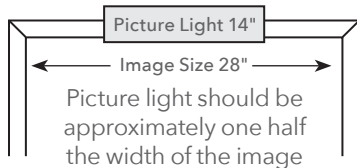

NOTE: Richardson Reflector Series Picture Lights with more than one arm, have a pre-wired, aluminum splice-box (2" x 2" x 5/8") which hangs behind the artwork.

Specifications

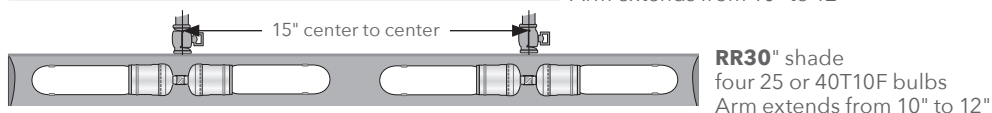
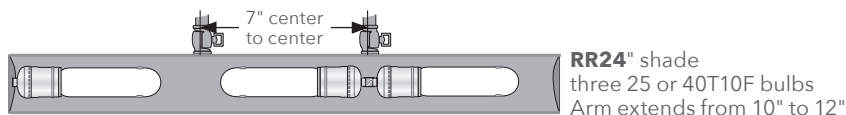
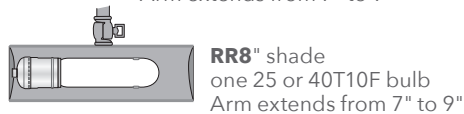
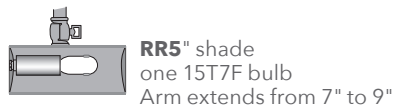

Finishes



Gold #1

Plug-In Advent Gemini LED



Features

- No damaging UV
- Horizontal arm extension of 19"
- Swivel with lever at shade to adjust light
- MR16 LED bulb, 3.5 Watts, 3000K, 75 CRI, 320 Lumens included
- Illuminates a 3' x 3' area
- 10' cord with plug-in driver (2" x 1³/₈" x 1") with switch 3' from plug

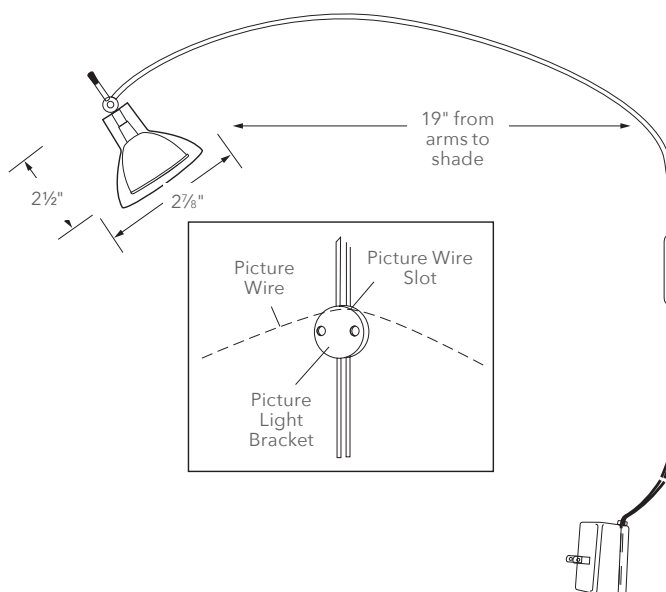

Finishes

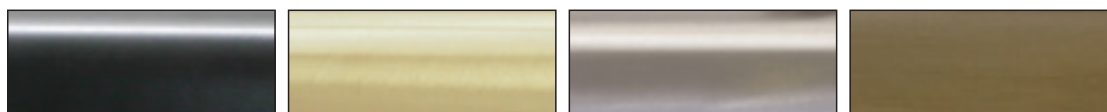

Black #7

Satin Brass #51

Satin Nickel #52

Antique Brass #71

Plug-In Advent Profile LED

APL25-71 (Antique Brass)



Features

- No damaging UV
- Removable shade for easy LED replacement
- LED bi-pin bulb included
- Polished metal reflector in shade for maximum light output
- Mount to frame or wall with included hardware
- 10' cord with plug-in driver (2¼" × 1⅜" × 1") with switch 3' from plug

Size Selection Guide

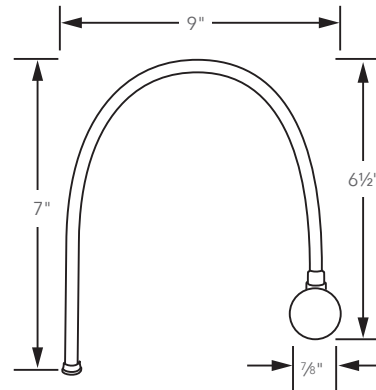
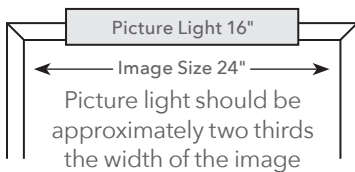

Finishes



Black #7

Satin Nickel #52

Polished Brass #61

Antique Brass #71

Oil Rubbed Bronze #91

Specifications

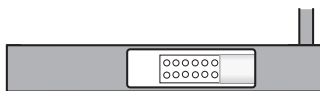

APL9
one 3000K, 85 CRI, 2 Watts, 140 Lumen LED

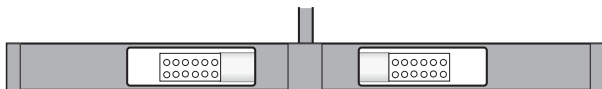

APL16
two 3000K, 85 CRI, 2 Watts, 140 Lumen LED

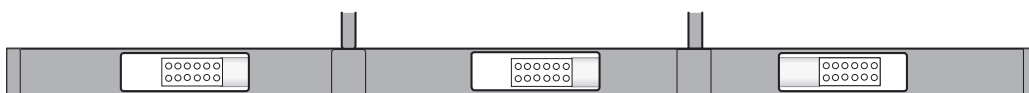

APL25
three 3000K, 85 CRI, 2 Watts, 140 Lumen LED

NOTE: Advent Profile Series Picture Lights with more than one arm, have a pre-wired, aluminum splice-box (2" × 2" × 5/8") which hangs behind the artwork.

Plug-In Advent Profile Incandescent



APR16-61 (Polished Brass)

Features

- Shade rotates to adjust light
- Removable shade for easy bulb replacement
- Paintable 8' ivory cord with In-line hi-lo switch 3' from plug
- Polished metal reflector in shade for maximum light output
- Mount to frame or wall with included hardware
- Optional LED bulbs available (LED 2.3W)

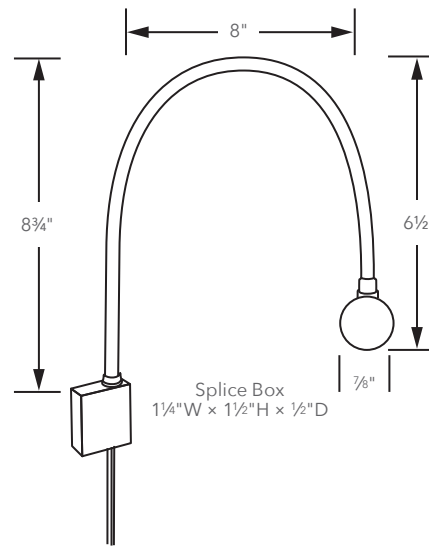

Size Selection Guide

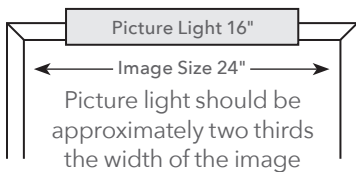

Finishes

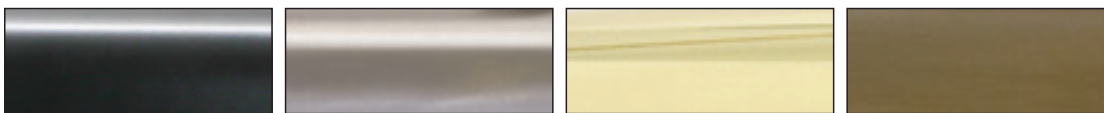

Black #7

Satin Nickel #52

Polished Brass #61

Antique Brass #71

Specifications



APR16" shade
two 15T4 bulbs included

Plug-In Advent Incandescent

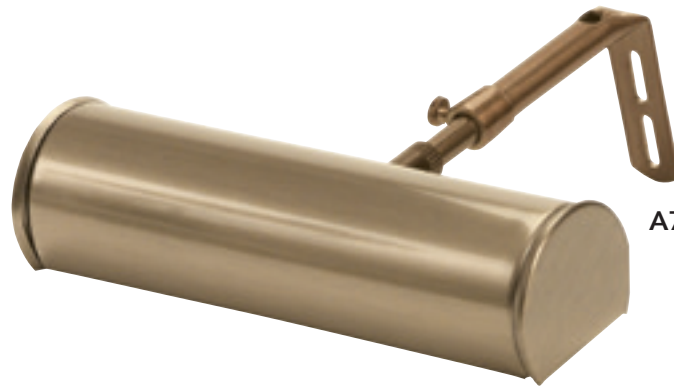

A7-71 (Antique Brass)

Features

- Swivel at shade for easy shade positioning
- Slide arm adjusts for horizontal extension
- Paintable 8' ivory cord with In-line hi-lo switch 3' from plug
- Polished metal reflector in shade for maximum light output
- Mount to frame or wall with included hardware

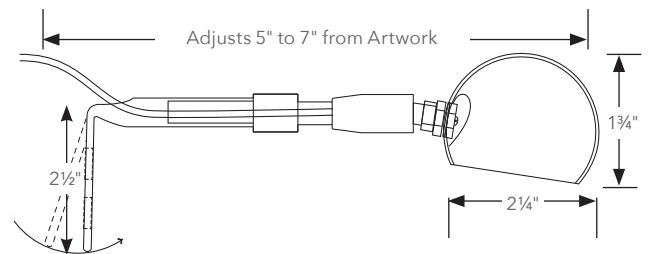

Size Selection Guide

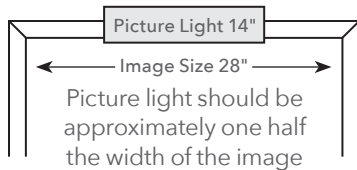

Finishes



Polished Brass #61

Antique Brass #71

Specifications

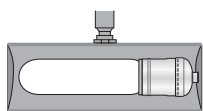

A7" shade
one 25T10F bulb

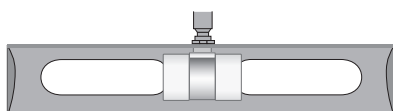

A14" shade
two 25T10F bulbs

Picture Lights – Direct Wire



Krista Watterworth Design Studio/Jessica Glynn Photography

Direct wire picture lights are the preferred installation for the contract industry. Mount your light on a junction box installed over art work so that the picture light sits a few inches from the top of the art. Use a dimmer switch to regulate the light.

Direct Wire Options

Incandescent

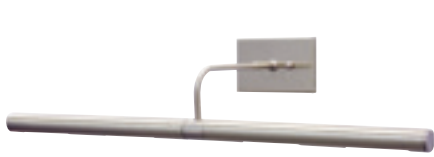

Slim-Line p. 32



Slim-Line XL p. 34



Traditional p. 42



Contemporary p. 46



Oxford p. 48



Steamer p. 53



Library p. 56



Library p. 57

LED

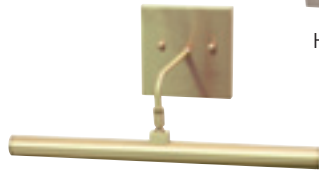

Slim-Line LED p. 35



Horizon LED p. 38



Mendon LED p. 36



Zenith LED p. 40

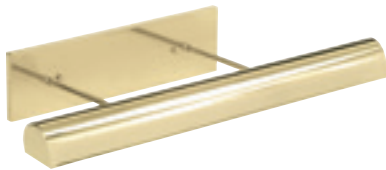

Traditional LED p. 44



Contemporary LED p. 47



Oxford LED p. 50



Steamer LED p. 51



Guilford LED p. 54



Library LED p. 58



Halo LED p. 60

Direct Wire Slim-Line Incandescent



Lisa Wolfe Design, LTD/Todd Pierson Photography

DSL24-51 (Satin Brass) shown

Finishes

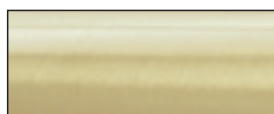

Satin Brass #51



Satin Nickel #52

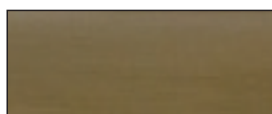

Antique Brass #71



Oil Rubbed Bronze #91

Direct Wire Slim-Line Incandescent

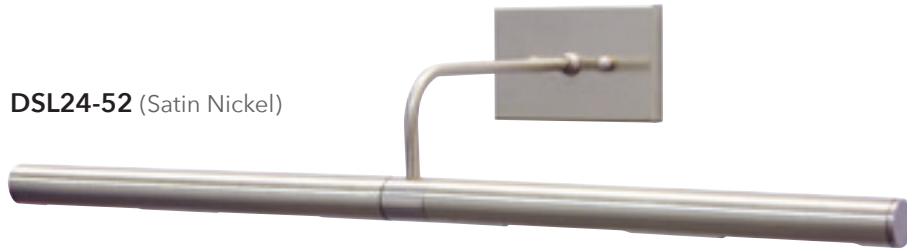

DSL24-52 (Satin Nickel)

Features

- Shade rotates to adjust light
- Tilt socket allows for easy bulb replacement
- Pebbled aluminum reflector provides maximum light output
- 2¾"H back plate fits 2" x 4" horizontally mounted junction box
- Polished metal reflector in shade for maximum light output
- Mount to frame or wall with included hardware
- Customization available upon request
- Optional LED bulbs available (LED 2.3W)

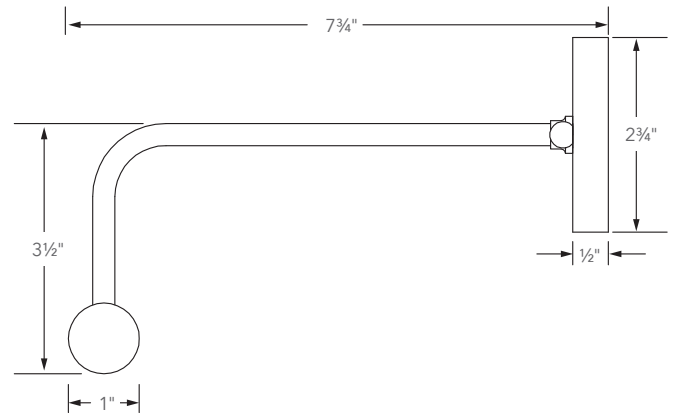

Size Selection Guide

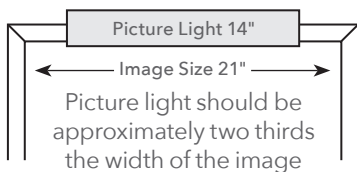

Specifications



DSL14" shade
two 15T4 bulbs
included

Backplate:
2¾"H x 4½"W



DSL24" shade
four 15T4 bulbs
included

Backplate:
2¾"H x 4½"W

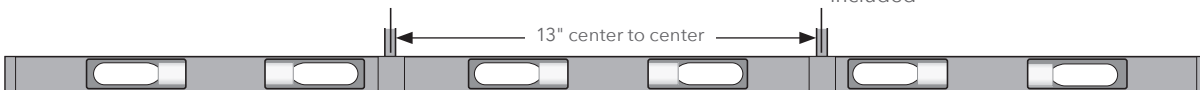

DSL36" shade
six 15T4 bulbs
included
Backplate:
2¾"H x 17½"W

Direct Wire Slim-Line XL Incandescent



Features

- Shade rotates to adjust light
- Tilt socket allows for easy bulb replacement
- Pebbled aluminum reflector provides maximum light output
- 5" diameter back plate fits octagon junction box
- 2 3/4"H back plate fits 2"x 4" horizontally mounted junction box
- Polished metal reflector in shade for maximum light output
- Mount to frame or wall with included hardware
- Customization available upon request
- Optional LED bulbs available (LED 2.3W)

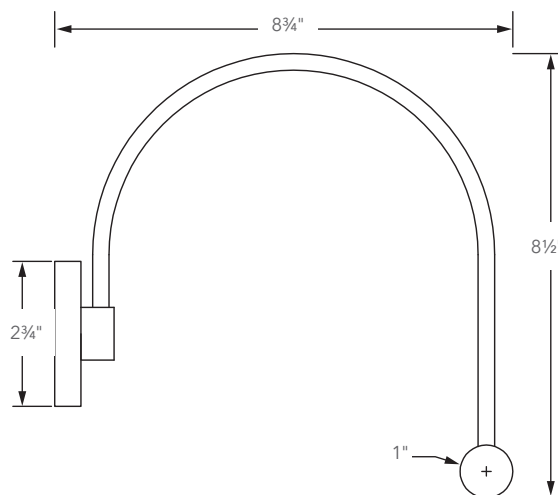
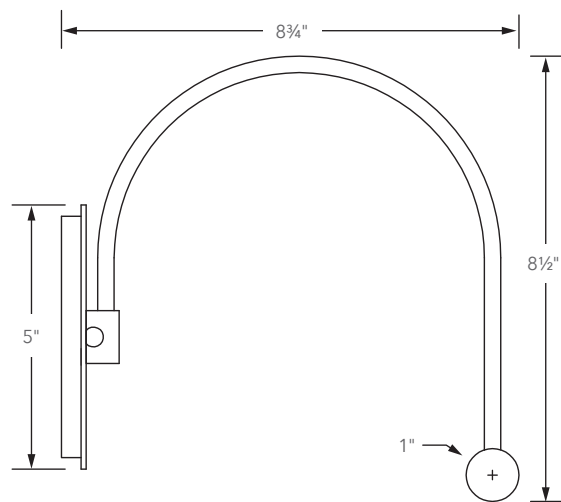

Size Selection Guide

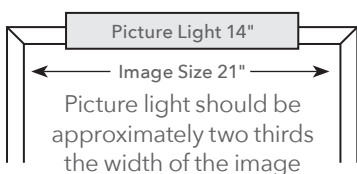

Finishes

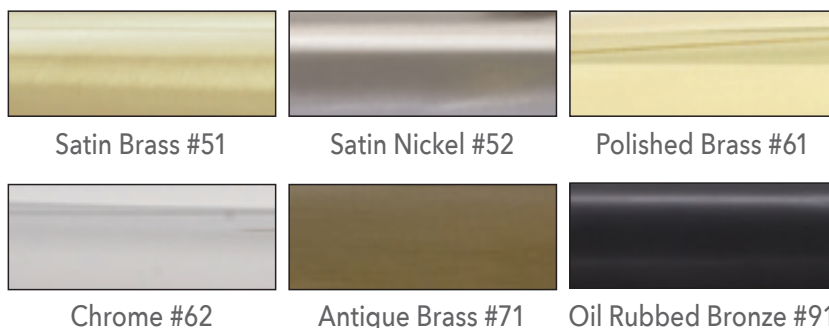

Specifications

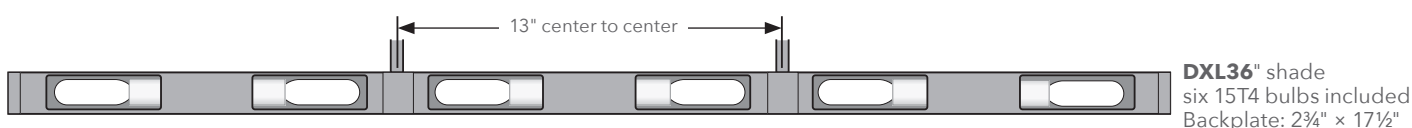

Direct Wire Slim-Line LED

DSLEDZ14-51 (Satin Brass)

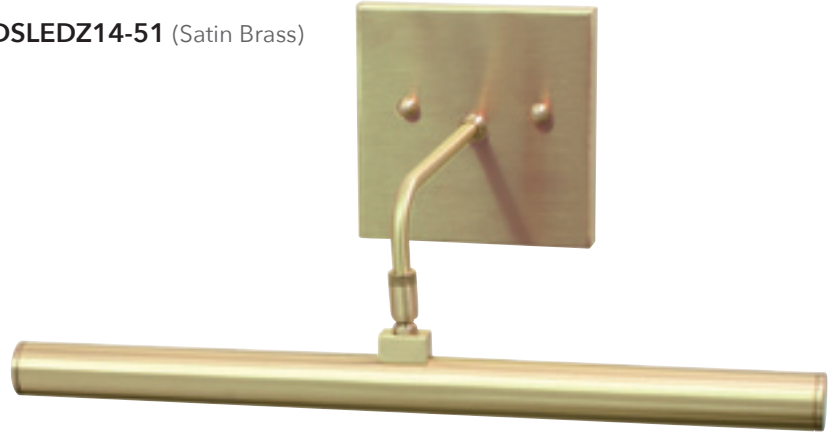

Features

- No damaging UV
- Line Voltage
- Dimmable to 5% with triac dimmer
- Diffused for even light spread
- 50,000 hour lifetime
- Five year warranty on LED array
- Shade Rotates to adjust light
- Polished metal reflector in shade for maximum light output
- 4½"H back plate will cover standard junction box
- Customization available upon request

Size Selection Guide

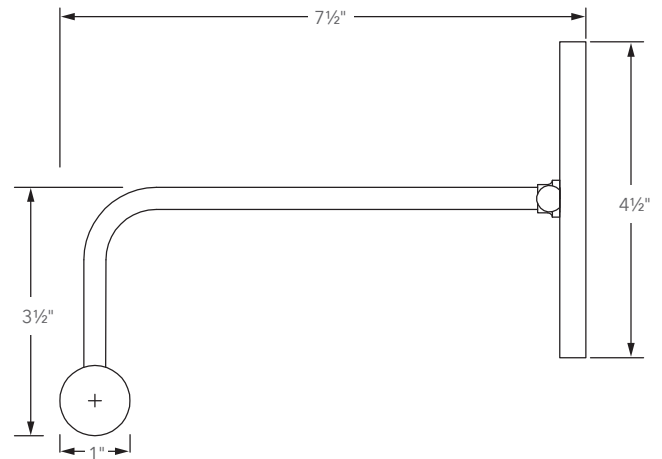
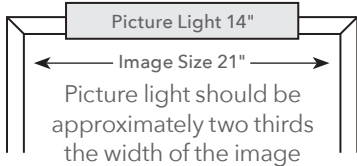

Finishes

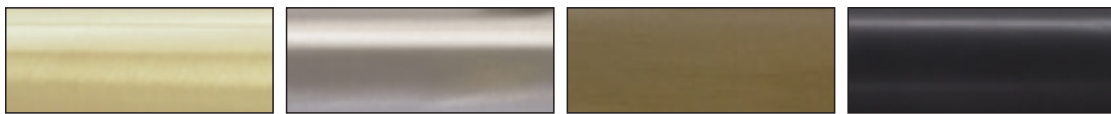

Satin Brass #51

Satin Nickel #52

Antique Brass #71

Oil Rubbed Bronze #91

Specifications

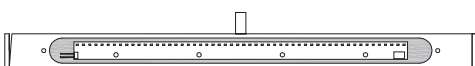

DSLEDZ14" shade
2700K, 90+ CRI, 4.5 Watt, 360 Lumen LED
Backplate: 4½" x 4½"

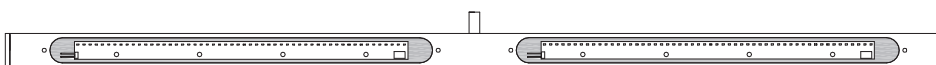

DSLEDZ28" shade
2700K, 90+ CRI, 9 Watt, 720 Lumen LED
Backplate: 4½" x 4½"

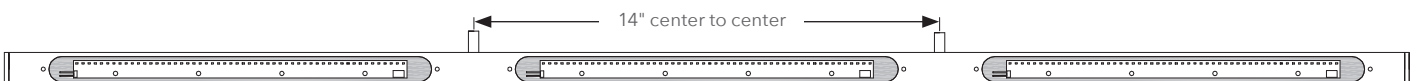

DSLEDZ43" shade
2700K, 90+ CRI, 13.5 Watt, 1080 Lumen LED
Backplate: 4½" x 17¾"

Direct Wire Mendon LED



DMLEDZ15-91 (Oil Rubbed Bronze) shown

Finishes



Satin Brass #51



Satin Nickel #52



Chrome #62



Antique Brass #71



Oil Rubbed Bronze #91

Direct Wire Mendon LED

DMLEDZ15-71 (Antique Brass)



Features

- No damaging UV
- Line Voltage
- Dimmable to 5% with triac dimmer
- Diffused for even light spread
- 50,000 hour lifetime
- Five year warranty on LED array
- Swivel at shade for easy shade positioning
- Polished metal reflector in shade for maximum light output
- 5" x 6" cover plate included for use with 4" x 4" junction box
- Customization available upon request

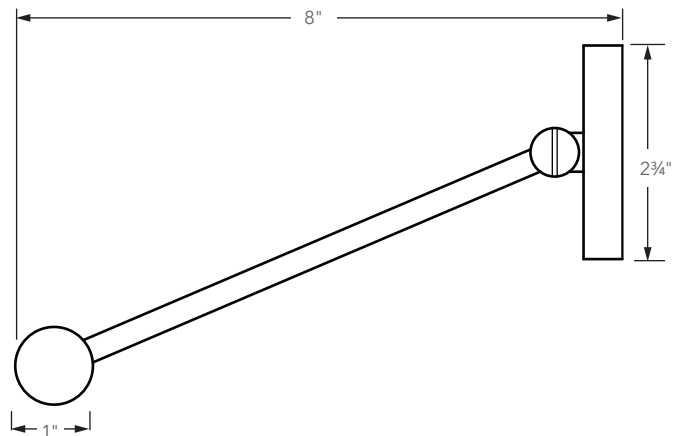

Size Selection Guide

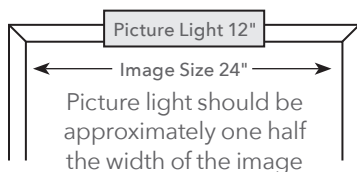

Specifications

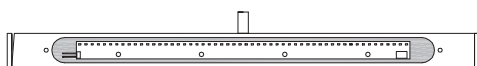

DMLEDZ15" shade
2700K, 90+ CRI, 4.5 Watt, 360 Lumen LED
Backplate: 4½" x 4½"



DMLEDZ29" shade
2700K, 90+ CRI, 9 Watt, 720 Lumen LED
Backplate: 4½" x 4½"

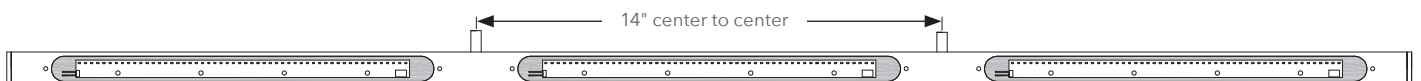

DMLEDZ43" shade
2700K, 90+ CRI, 13.5 Watt, 1080 Lumen LED
Backplate: 4½" x 17¾"

Direct Wire Horizon LED



DHLEDZ12-51 (Satin Brass) shown

Finishes

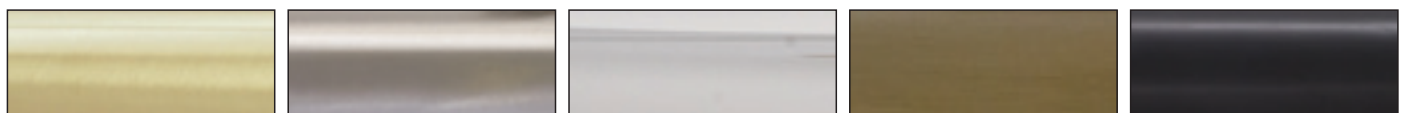

Satin Brass #51

Satin Nickel #52

Chrome #62

Antique Brass #71

Oil Rubbed Bronze #91

Direct Wire Horizon LED



DHLEDZ26-52 (Satin Nickel)

Features

- No damaging UV
- Line Voltage
- Dimmable to 5% with triac dimmer
- Diffused for even light spread
- 50,000 hour lifetime
- Five year warranty on LED array
- Swivel at shade for easy shade positioning
- Polished metal reflector in shade for maximum light output
- 4½"H back plate will cover standard junction box
- Customization available upon request

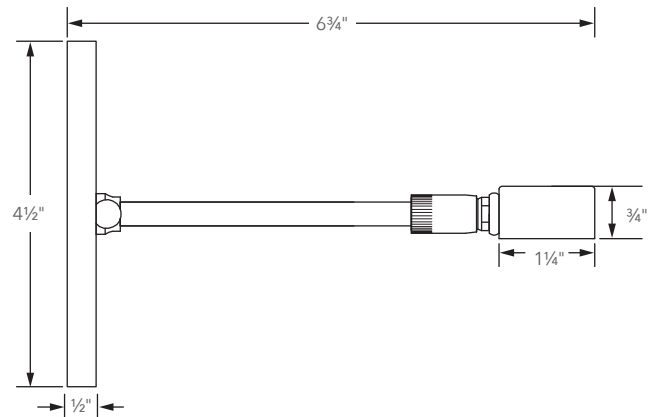

Size Selection Guide

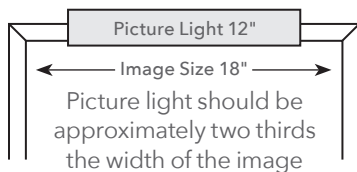

Specifications

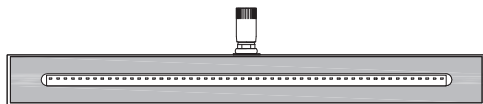

DHLEDZ12" shade
2700K, 90+ CRI, 4.5 Watt, 360 Lumen LED
Backplate: 4½" × 4½"

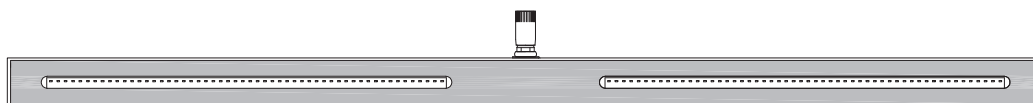

DHLEDZ26" shade
2700K, 90+ CRI, 9 Watt, 720 Lumen LED
Backplate: 4½" × 4½"

Direct Wire Zenith LED



DZLEDZ12-91 (Oil Rubbed Bronze) shown

Finishes



Satin Brass #51



Satin Nickel #52

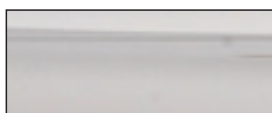

Chrome #62

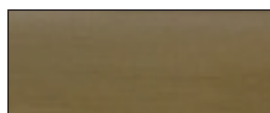

Antique Brass #71



Oil Rubbed Bronze #91

Direct Wire Zenith LED



DZLEDZ36-52 (Satin Nickel)

Features

- No damaging UV
- Line Voltage
- Dimmable to 5% with triac dimmer
- Diffused for even light spread
- 50,000 hour lifetime
- Five year warranty on LED array
- Swivel at shade for easy shade positioning
- Polished metal reflector in shade for maximum light output
- 4½"H back plate will cover standard junction box
- Customization available upon request

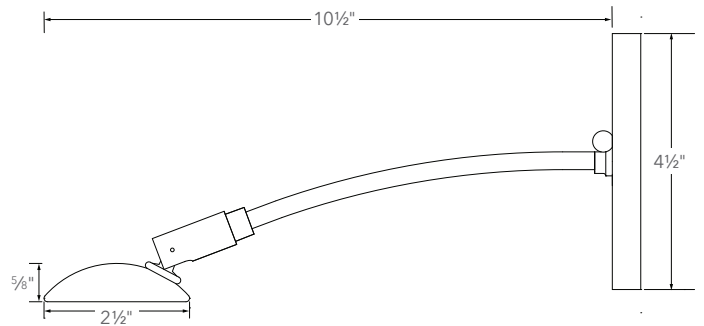

Size Selection Guide

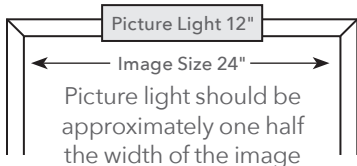

Specifications

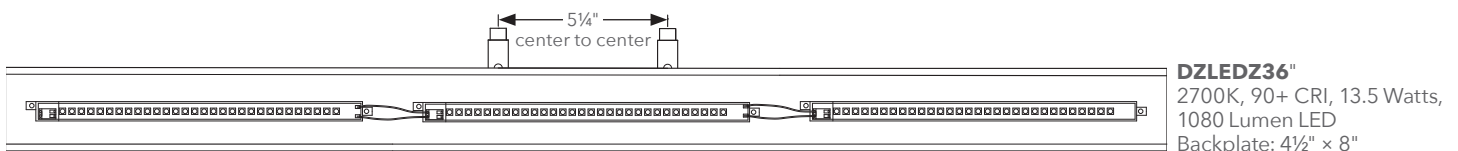
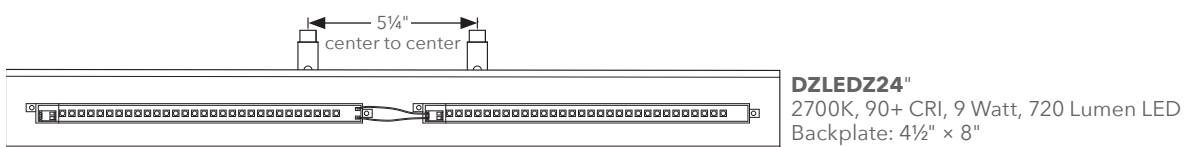

Direct Wire Traditional Incandescent



DT14-71 (Antique Brass) shown

Finishes

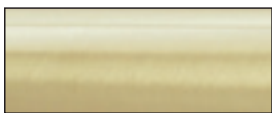

Satin Brass #51

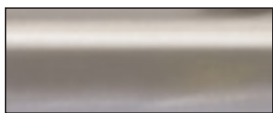

Satin Nickel #52



Polished Brass #61

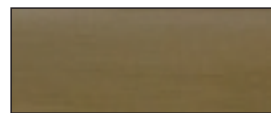

Antique Brass #71



Mahogany Bronze #81

Direct Wire Traditional Incandescent



DT24-81 (Mahogany Bronze)

Features

- Swivel at shade for easy shade positioning
- Polished metal reflector in shade for maximum light output
- 4½"H back plate will cover standard junction box
- Customization available upon request

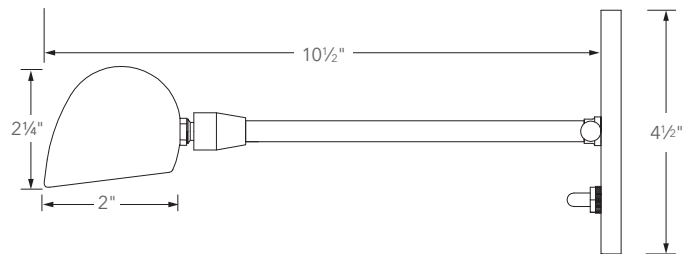

Size Selection Guide

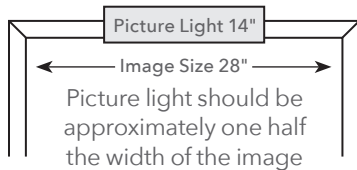

Specifications

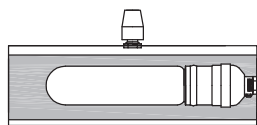

DT8" shade
one 25 or 40T10F bulb
Backplate: 4½" x 4½"

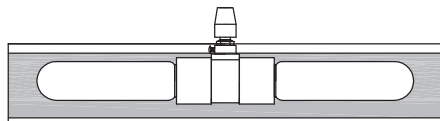

DT14" shade
two 25 or 40T10F bulbs
Backplate: 4½" x 4½"

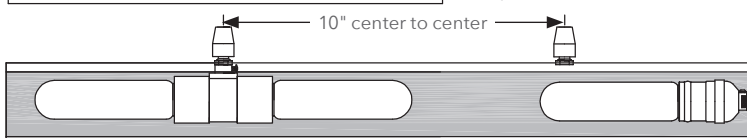

DT24" shade
three 25 or 40T10F bulbs
Backplate: 4" x 15"

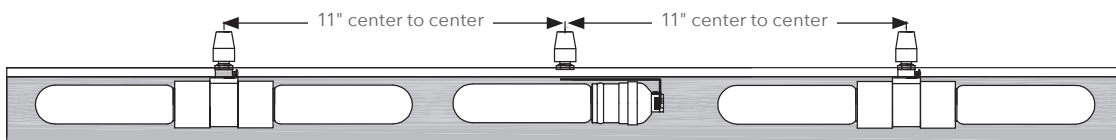

DT36" shade
five 25 or 40T10F bulbs
Backplate: 4" x 26"

Direct Wire Traditional LED

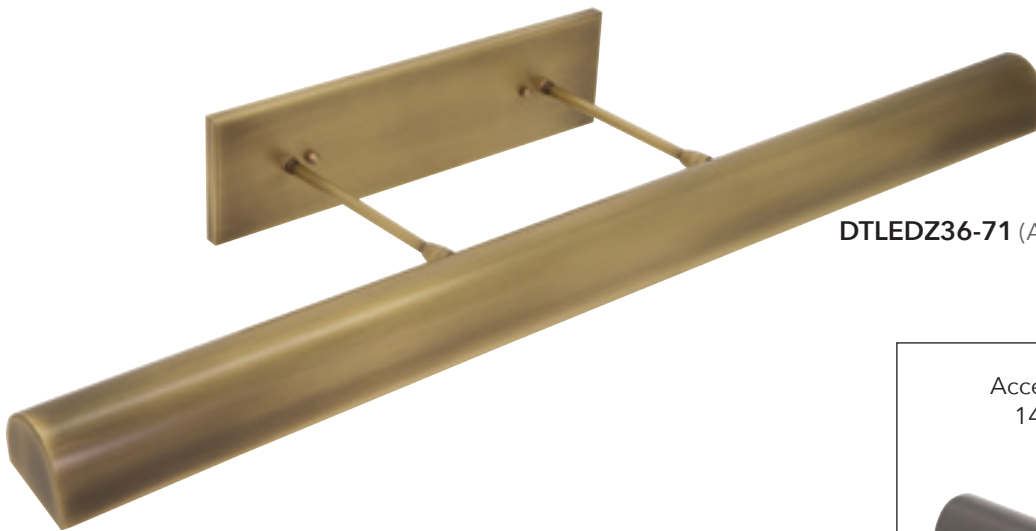

DTLEDZ36-71 (Antique Brass)

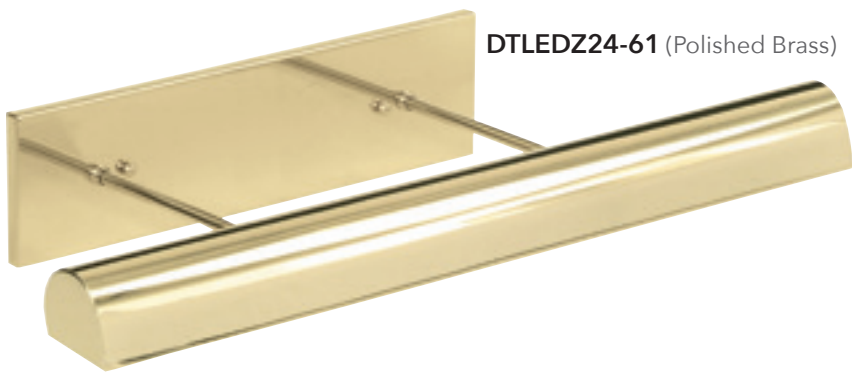

DTLEDZ24-61 (Polished Brass)



DTLEDZ14-81 (Mahogany Bronze)



DTBLEDZ14-MB/AB

DTRLEDZ14-SN/PN

DTSLEDZ14-AB/PB

Finishes



Satin Brass #51

Satin Nickel #52

Polished Brass #61

Antique Brass #71

Mahogany Bronze #81

Accent Finish Combinations

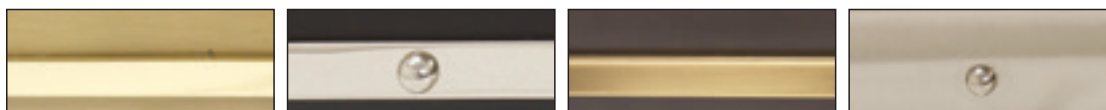

Antique Brass and Polished Brass
AB/PB

Black and Polished Nickel
BLK/SN

Mahogany Bronze and Antique Brass
MB/AB

Satin Nickel and Polished Nickel
SN/PN

Direct Wire Traditional LED

Features

- No damaging UV
- Line Voltage
- Dimmable to 5% with triac dimmer
- Diffused for even light spread
- 50,000 hour lifetime
- Five year warranty on LED array
- Swivel at shade for easy shade positioning
- Polished metal reflector in shade for "maximum light output
- 4½"H back plate will cover standard junction box
- Customization available upon request

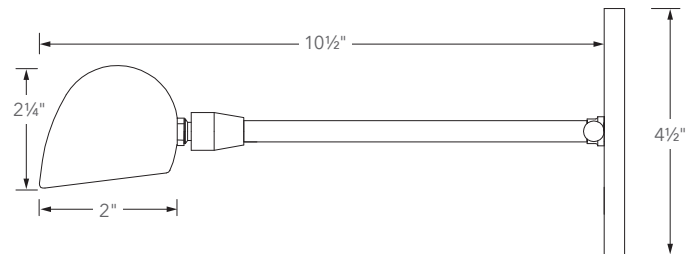

Size Selection Guide

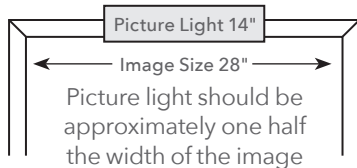

Specifications

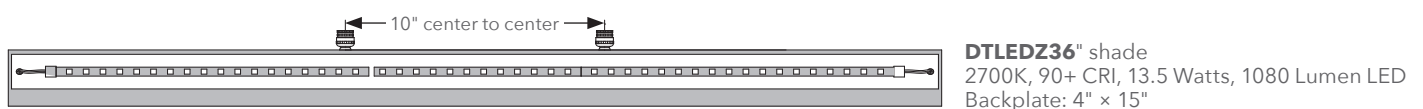

Direct Wire Contemporary Incandescent



DC9-62 (Chrome)

Features

- Swivel at shade for easy shade positioning
- Polished metal reflector in shade for maximum light output
- 4½"H back plate will cover standard junction box
- Customization available upon request

Size Selection Guide

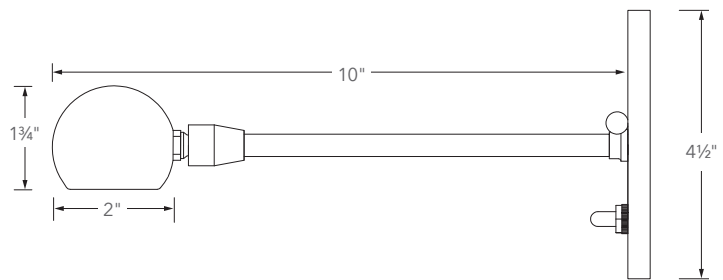
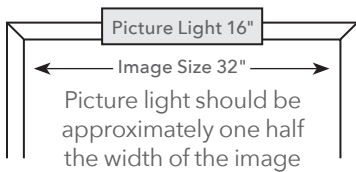

Finishes

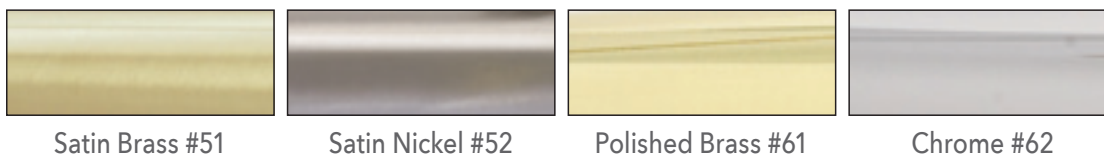

Satin Brass #51

Satin Nickel #52

Polished Brass #61

Chrome #62

Specifications

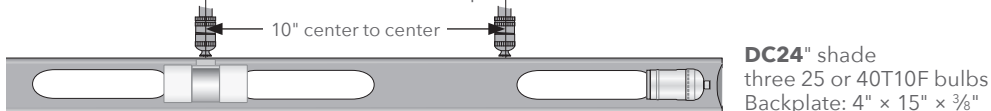
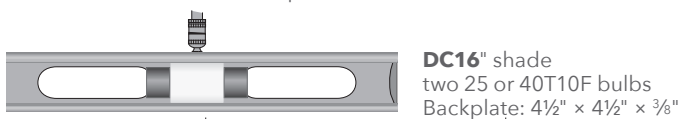

Direct Wire Contemporary LED

DCLEDZ12-52 (Satin Nickel)

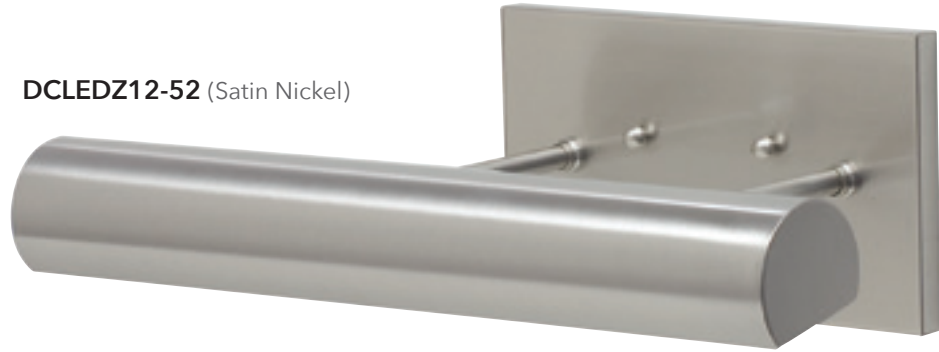

Features

- No damaging UV
- Line Voltage
- Dimmable to 5% with triac dimmer
- Diffused for even light spread
- 50,000 hour lifetime
- Five year warranty on LED array
- Swivel at shade for easy shade positioning
- Polished metal reflector in shade for maximum light output
- 4½"H back plate will cover standard junction box
- Customization available upon request

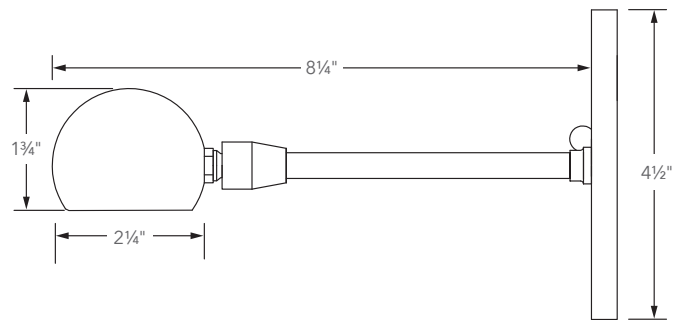

Size Selection Guide

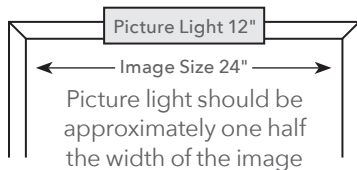

Finishes



Satin Brass #51

Satin Nickel #52

Antique Brass #71

Specifications

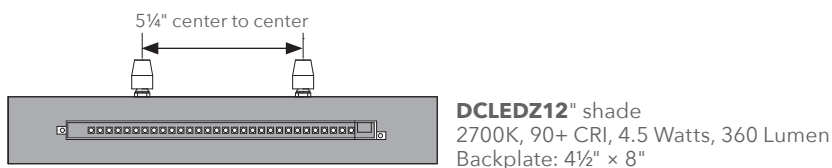

DCLEDZ12" shade
2700K, 90+ CRI, 4.5 Watts, 360 Lumen
Backplate: 4½" x 8"

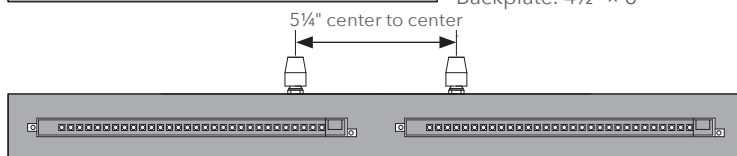

DCLEDZ24" shade
2700K, 90+ CRI, 9 Watt, 720 Lumen
Backplate: 4½" x 8"

Direct Wire Oxford Incandescent



DOX16-AB (Antique Brass) shown

Finishes



Antique Brass (AB)

Oil Rubbed Bronze (OB)

Satin Nickel (SN)

Direct Wire Oxford Incandescent



DOX42-SN (Satin Nickel)

Features

- Swivel at shade for easy shade positioning
- Polished metal reflector in shade for maximum light output
- 4½"H back plate will cover standard junction box
- Customization available upon request
- Optional 10' cord and cord cover kit for plug-in version sold separately (OXCC-AB, OXCC-OB, OXCC-SN)

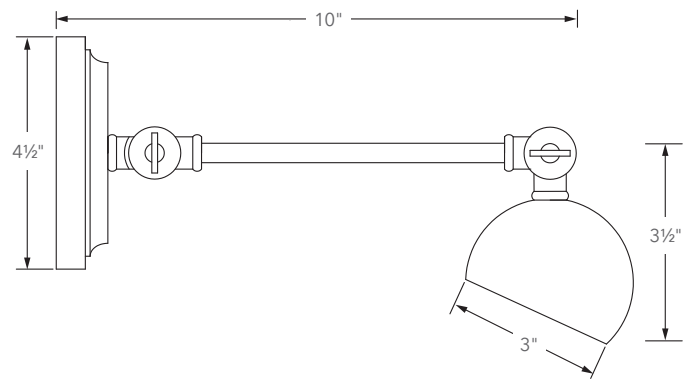

Size Selection Guide

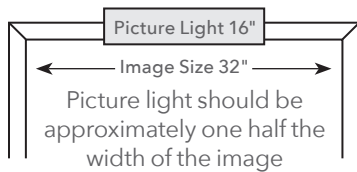

Specifications

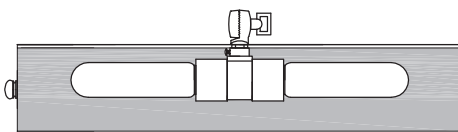

DOX16" shade
two 25 or 40T10F bulbs
Backplate: 4½" x 6"

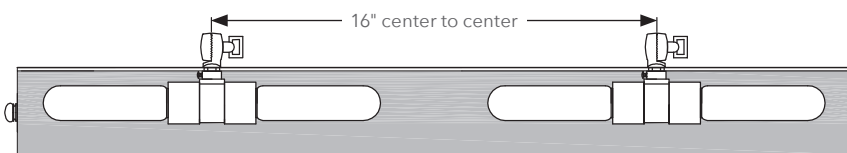

DOX30" shade
four 25 or 40T10F bulbs
Backplate: 4½" x 20"

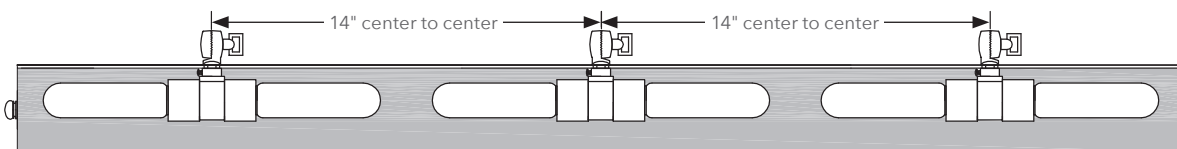

DOX42" shade
six 25 or 40T10F bulbs
Backplate: 4½" x 32"

Direct Wire Oxford LED



DOXLEDZ30-OB (Oil Rubbed Bronze)

Available finishes shown on page 46

Features

- No damaging UV
- Line Voltage
- Dimmable to 5% with triac dimmer
- Diffused for even light spread
- 50,000 hour lifetime
- Five year warranty on LED array
- Swivel at shade for easy shade positioning
- Polished metal reflector in shade for maximum light output
- 4½"H back plate will cover standard junction box
- Customization available upon request

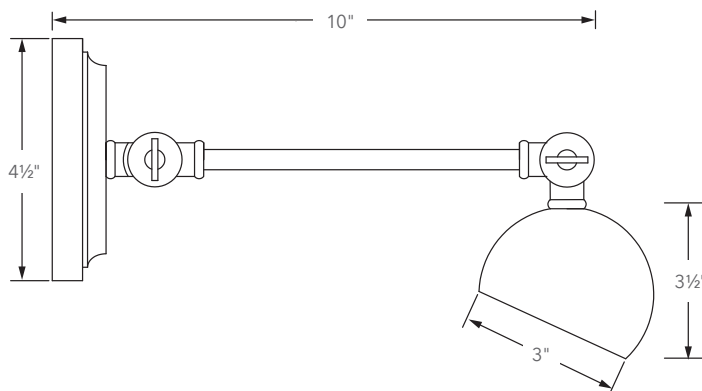

Size Selection Guide

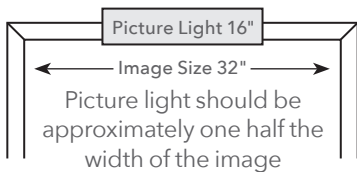

Specifications

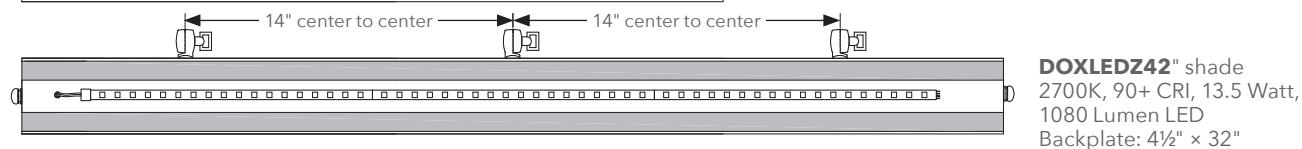
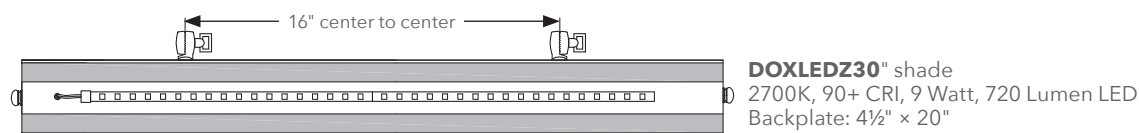
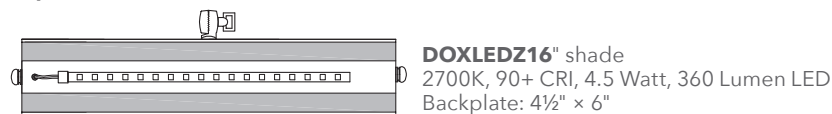

Direct Wire Steamer LED



DSTLEDZ16-MBAB (Mahogany Bronze with Antique Brass) shown

Finishes



Antique Brass and
Mahogany Bronze
ABMB



Mahogany Bronze
and Antique Brass
MBAB



Satin Nickel
and Black
SNBLK

Direct Wire Steamer LED

DSTLEDZ42-ABMB

(Antique Brass and Mahogany Bronze)



Features

- No damaging UV
- Line Voltage
- Dimmable to 5% with triac dimmer
- Diffused for even light spread
- 50,000 hour lifetime
- Five year warranty on LED array
- Swivel at shade for easy shade positioning
- Polished metal reflector in shade for maximum light output
- 4½"H back plate will cover standard junction box
- Customization available upon request

Size Selection Guide

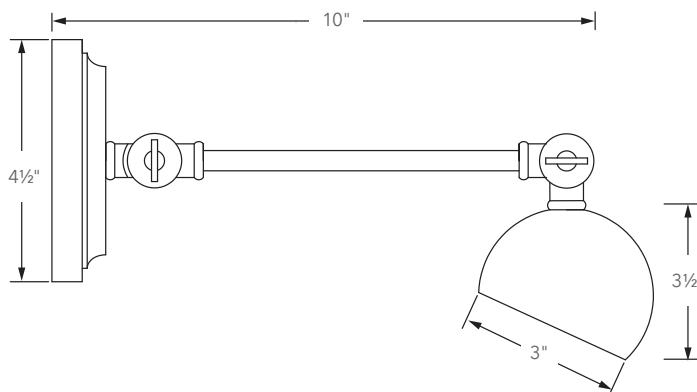
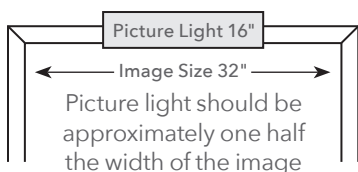

Specifications

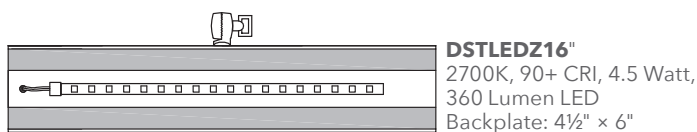

DSTLEDZ16"
2700K, 90+ CRI, 4.5 Watt,
360 Lumen LED
Backplate: 4½" x 6"

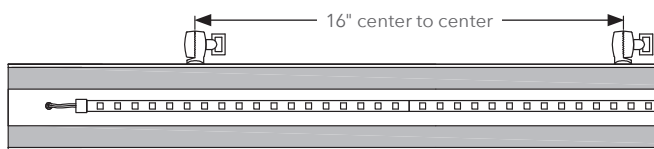

DSTLEDZ30"
2700K, 90+ CRI, 9 Watt,
720 Lumen LED
Backplate: 4½" x 20"

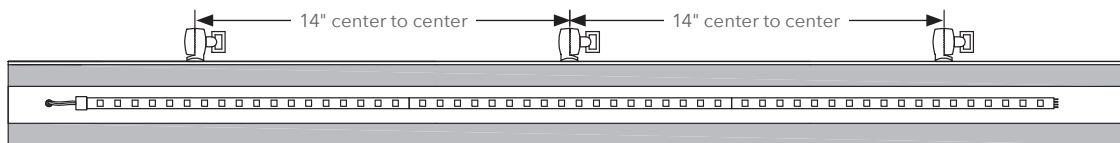

DSTLEDZ42"
2700K, 90+ CRI, 13.5
Watt, 1080 Lumen LED
Backplate: 4½" x 32"

Direct Wire Steamer Incandescent



DST42-SNBLK (Satin Nickel and Black)
Available finishes shown on page 49

Features

- Swivel at shade for easy shade positioning
- Polished metal reflector in shade for maximum light output
- 4½"H back plate will cover standard junction box
- Customization available upon request
- Optional 10' cord and cord cover kit for plug-in version sold separately (OXCC-AB, OXCC-OB, OXCC-SN)

Size Selection Guide

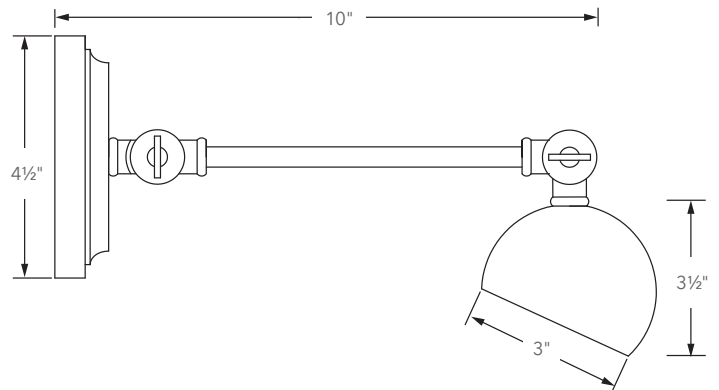
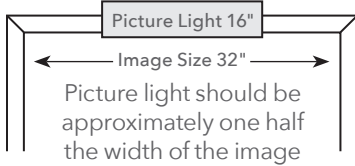

Specifications

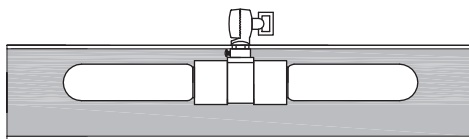

DST16" shade
two 25 or 40T10F bulbs
Backplate: 4½" x 6"

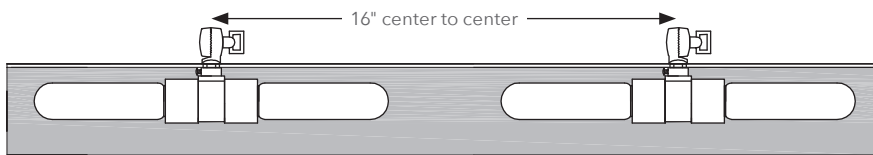

DST30" shade
four 25 or 40T10F bulbs
Backplate: 4½" x 20"

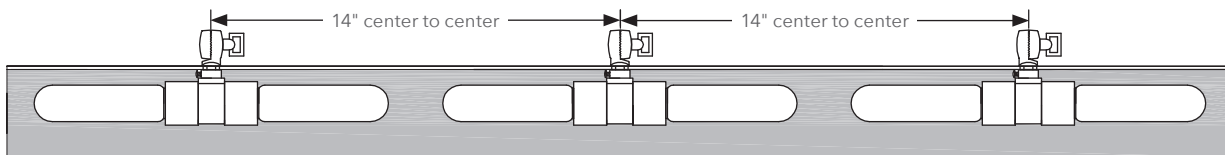

DST42" shade
six 25 or 40T10F bulbs
Backplate: 4½" x 32"

Direct Wire Guilford LED



DGLEDZ24-AB (Antique Brass) shown

Finishes

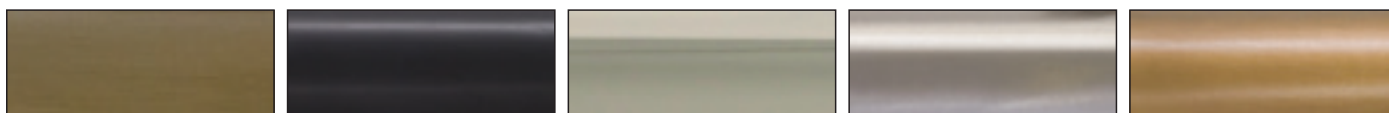

Antique Brass (AB)

Oil Rubbed Bronze (OB)

Polished Nickel (PN)

Satin Nickel (SN)

Weathered Brass (WB)

Direct Wire Guilford LED

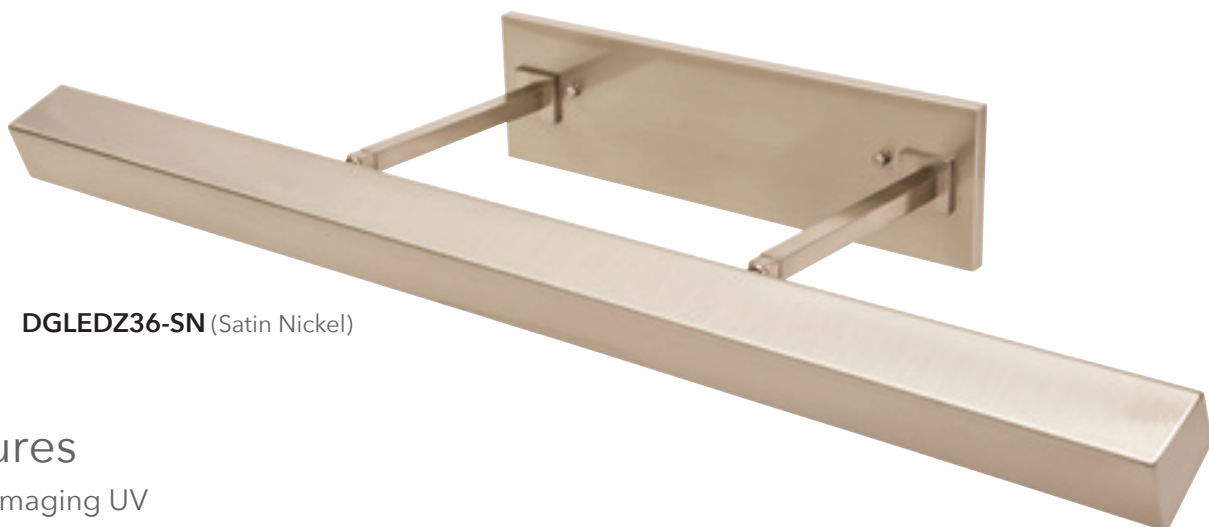

DGLEDZ36-SN (Satin Nickel)

Features

- No damaging UV
- Line Voltage
- Dimmable to 5% with triac dimmer
- Diffused for even light spread
- 50,000 hour lifetime
- Five year warranty on LED array
- Swivel at shade for easy shade positioning
- Polished metal reflector in shade for maximum light output
- 4½"H back plate will cover standard junction box
- Customization available upon request

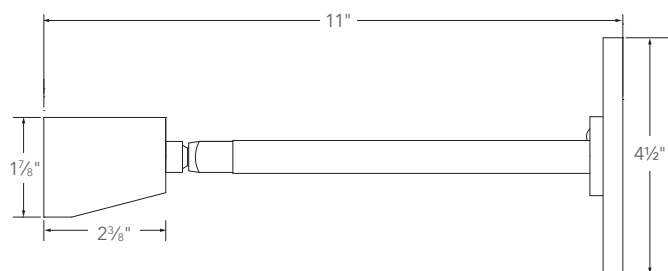

Size Selection Guide

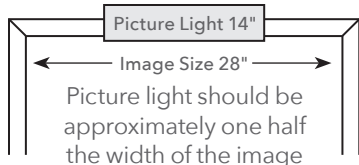

Specifications

DGLEDZ14"
2700K, 90+ CRI, 4.5 Watt, 360 Lumen
LED Backplate: 4½" × 8"

DGLEDZ24"
2700K, 90+ CRI, 9 Watt, 720 Lumen LED
Backplate: 4½" × 12"

DGLEDZ36"
2700K, 90+ CRI, 13.5 Watt, 1080 Lumen LED
Backplate: 4½" × 16"

Direct Wire Library Incandescent



PL16-OB (Oil Rubbed Bronze)

Features

- Swivel at shade for easy shade positioning
- Paintable 8' ivory cord with In-line hi-lo switch 3' from plug
- Polished metal reflector in shade for maximum light output
- Convertible, comes with 30" cord cover for plug in
- Customization available upon request

Size Selection Guide

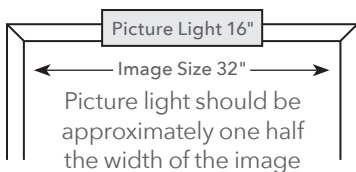

Available as a custom direct mount. Refer to page 65 for details.

Finishes

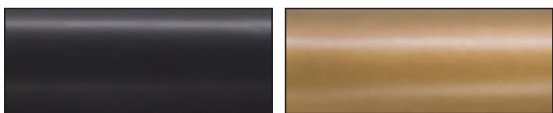

Oil Rubbed Bronze #91 Weathered Brass #76

Specifications

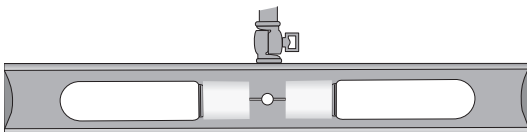

PL16"
two 25 or 40T10F bulbs
Backplate: 5" diameter

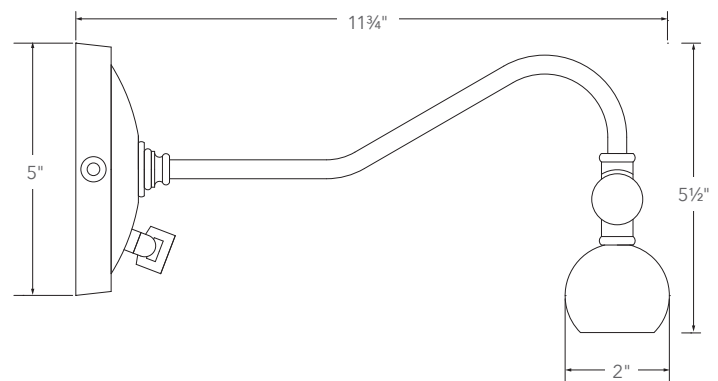

Direct Wire Library Incandescent



Features

- Swivel at shade for easy shade positioning
- Polished metal reflector in shade for maximum light output
- 2¾"H back plate will cover 2" × 4" junction box
- Customization available upon request

Size Selection Guide

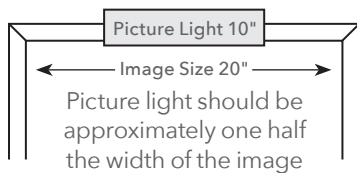

Available as a custom direct mount. Refer to page 65 for details.

Finishes

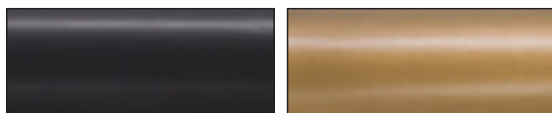

Oil Rubbed Bronze #91 Weathered Brass #76

Specifications

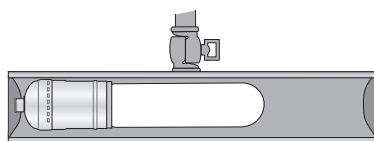

DL10"

one 25 or 40T10F bulbs

Backplate: 2¾ × 4½"

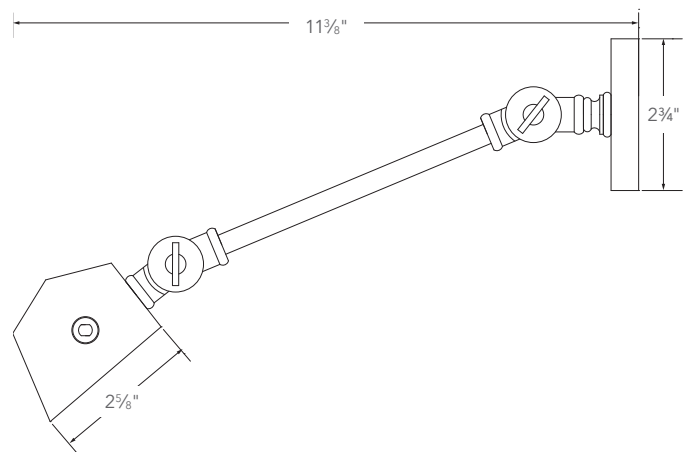

Direct Wire Library LED



LLED30-SN (Satin Nickel) shown

Finishes

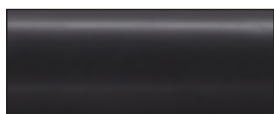

Oil Rubbed Bronze #91



Satin Nickel (SN)

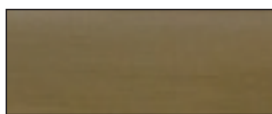

Antique Brass (AB)

Direct Wire Library LED



Features

- Direct wire only
- No damaging UV
- Dimmable with an ELV dimmer
- Diffused for even light spread
- 50,000 hour lifetime
- Multiple swivels for easy shade positioning
- 5" diameter back plate will cover octagon junction box
- One integrated 3000K, 80 CRI, 6.2 Watt, 600 Lumen LED included

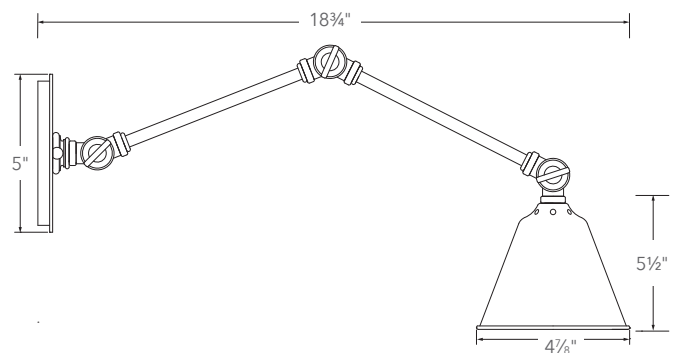

Direct Wire Halo LED



DHA24-BLK (Black) shown

Finishes



Antique Brass (AB)

Black (BLK)

Mahogany Bronze (MB)

Satin Nickel (SN)

White (WT)

Direct Wire Halo LED

DHA05-SN (Satin Nickel)



Features

- Direct wire only
- No damaging UV
- Dimmable with an ELV dimmer
- Diffused for even light spread
- 50,000 hour lifetime
- Swivel at shade for easy shade positioning
- 5" diameter back plate will cover octagon junction box
- 4½"H back plate will cover standard junction box

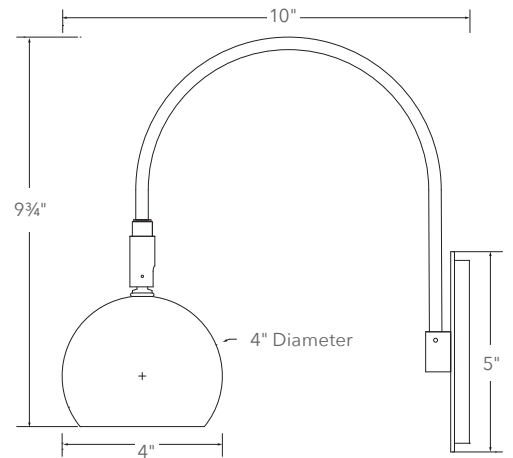

Specifications



DHA05
one 3000K, 80CRI, 6.2 Watt, 600 Lumen LED
Backplate: 5" diameter

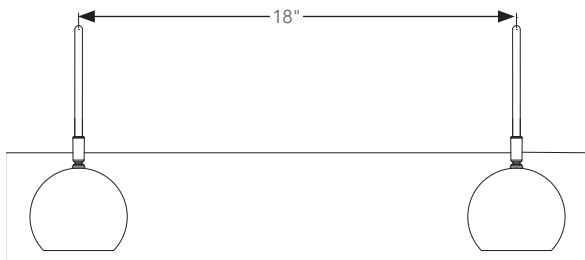

DHA24
two 3000K, 80CRI, 6.2 Watt, 600 Lumen LED
Backplate: 4½" x 24"

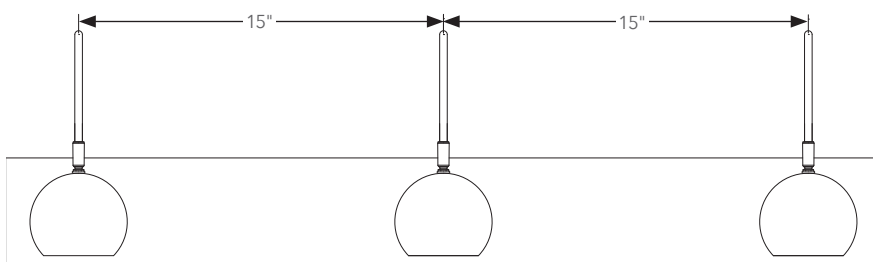
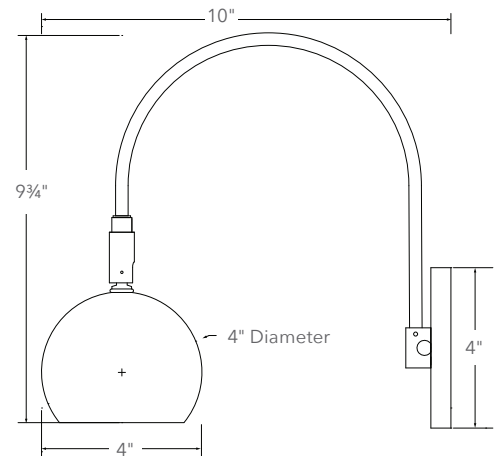

DHA05
three 3000K, 80CRI, 6.2 Watt, 600 Lumen LED
Backplate: 4½" x 36"

Picture Lights – Battery Operated



Sarah Gibson, Designer & Blogger, Room for Tuesday

Battery operated picture lights are a great solution when it is impossible to get power to your picture light. Our battery-operated picture lights are LED, which use less power and give adequate illumination to light your art work for as long as 48 hours.

Battery Operated Slim-Line™ LED

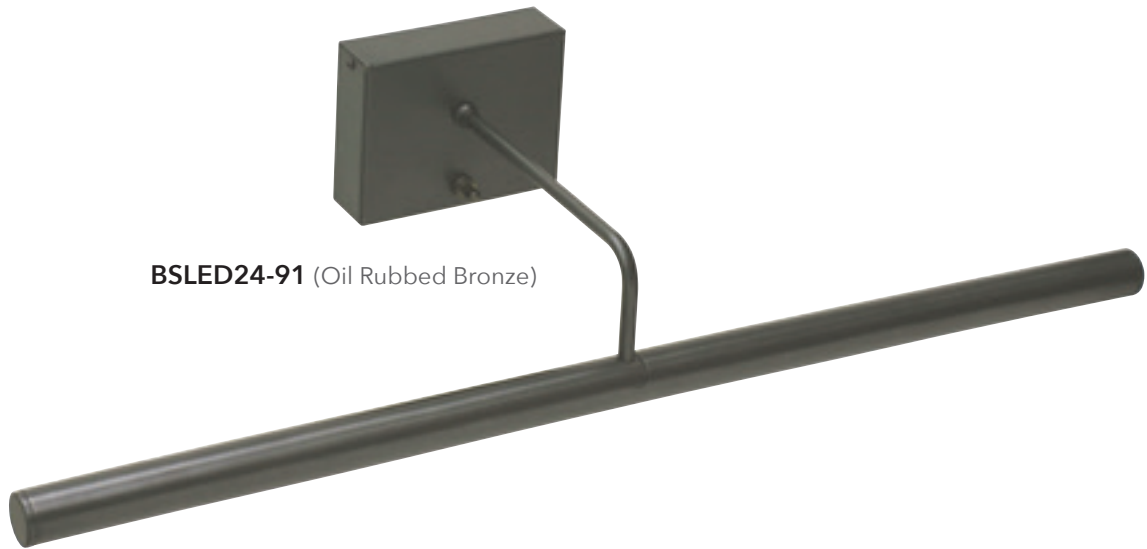

BSLED24-91 (Oil Rubbed Bronze)

Features

- Operates on four c-cell batteries (not included)
- Battery Life 36-48 hours
- No damaging UV
- 50,000 hour lifetime
- Swivel at shade to adjust light
- Polished metal reflector in shade for maximum light output

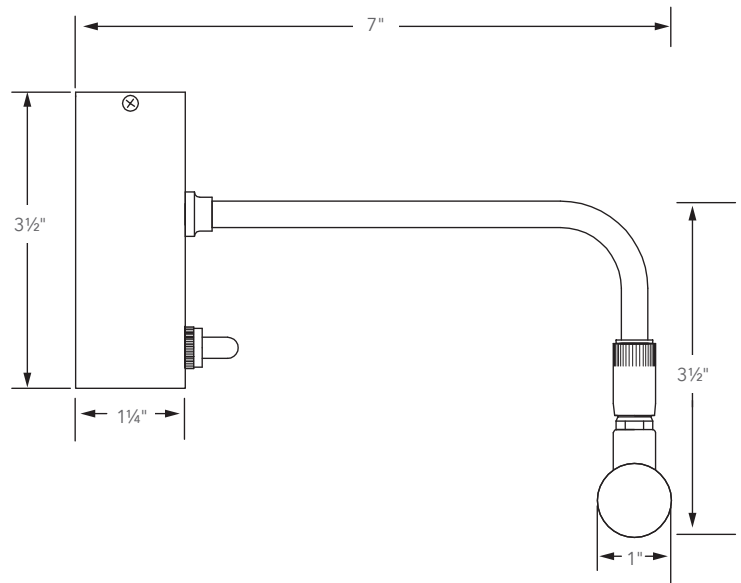

Size Selection Guide

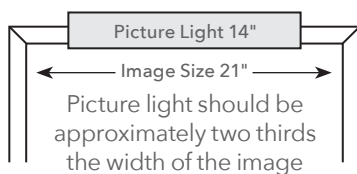

Finishes

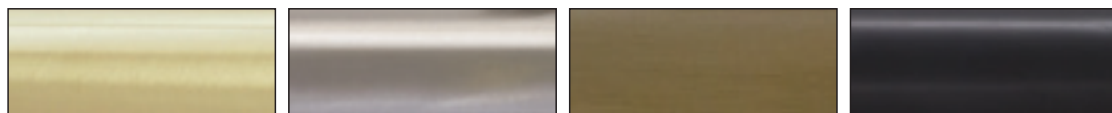

Satin Brass #51

Satin Nickel #52

Antique Brass #71

Oil Rubbed Bronze #91

Specifications

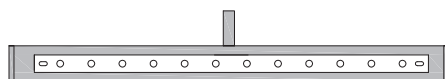

BSLED12" shade
3000K, 75 CRI, 1.6 Watt, 44 Lumen LED
Backplate: 4 1/2" x 3 1/2"

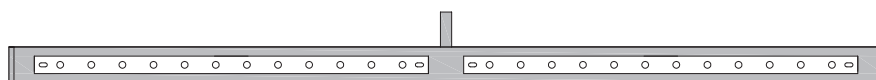

BSLED24" shade
3000K, 75 CRI, 3.2 Watt, 88 Lumen LED
Backplate: 4 1/2" x 3 1/2"

Battery Operated Traditional LED



Sarah Gibson, Designer & Blogger, Room for Tuesday

BTLED14-71 (Antique Brass) shown

Finishes



Gold #1

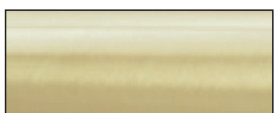

Satin Brass #51

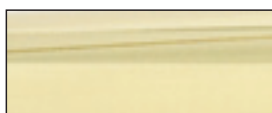

Polished Brass #61

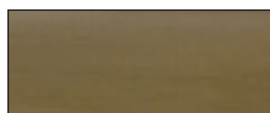

Antique Brass #71



Mahogany Bronze #81

Battery Operated Traditional LED

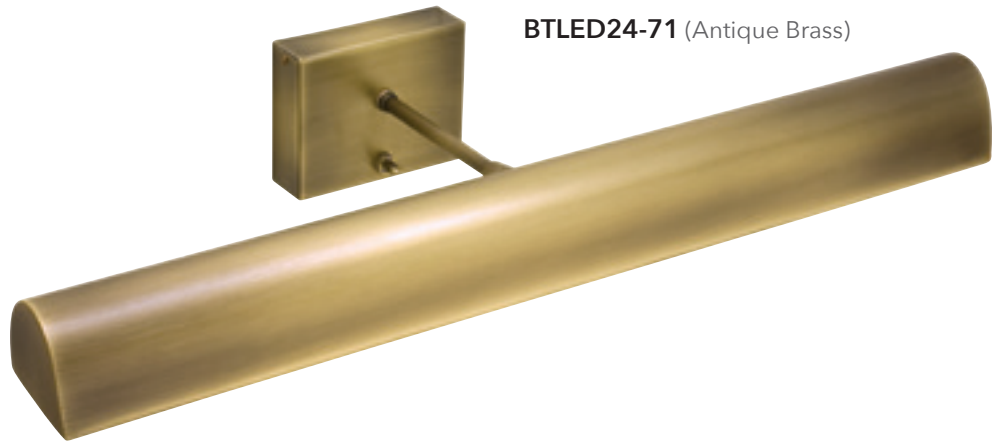

BTLED24-71 (Antique Brass)

Features

- Operates on four c-cell batteries (not included)
- Battery Life 36-48 hours
- No damaging UV
- 50,000 hour lifetime
- Swivel at shade to adjust light
- Polished metal reflector in shade for maximum light output

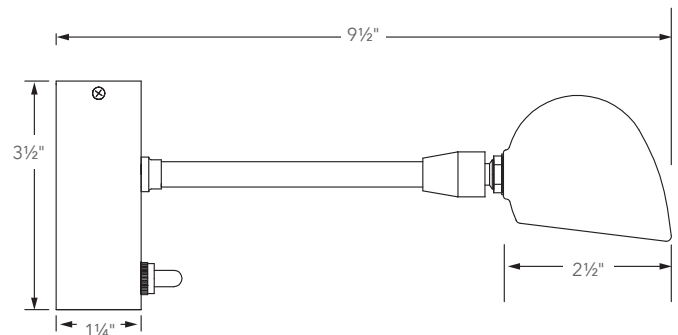

Size Selection Guide

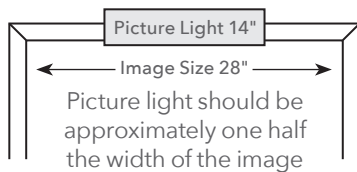

Specifications

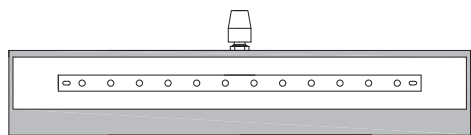

BTLED14" shade
3000K, 75 CRI, 1.6 Watt, 44 Lumen LED
Backplate: 4 1/2" x 3 1/2"

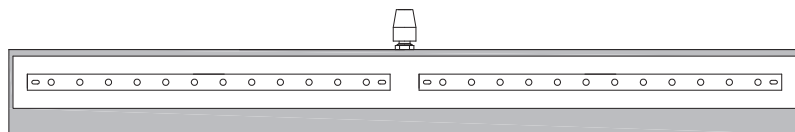

BTLED24" shade
3000K, 75 CRI, 3.2 Watt, 88 Lumen LED
Backplate: 4 1/2" x 3 1/2"

Battery Operated Advent Standard LED



ABLED14-61 (Antique Brass)

Features

- Operates on AA batteries (not included)
- Battery Life 36-48 hours
- No damaging UV
- Slide arm adjusts for horizontal extension
- Swivel at shade to adjust light
- Polished metal reflector in shade for maximum light output
- Mounts to frame or wall with included hardware

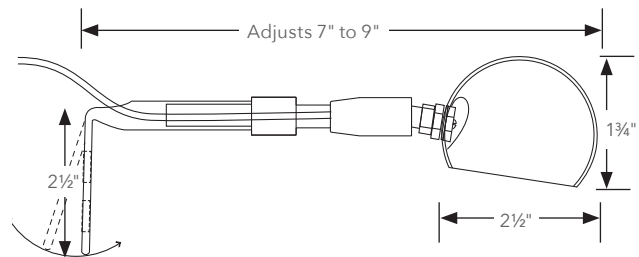

Size Selection Guide

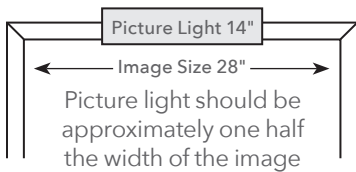

Finishes



Polished Brass #71

Antique Brass (AB)

Specifications

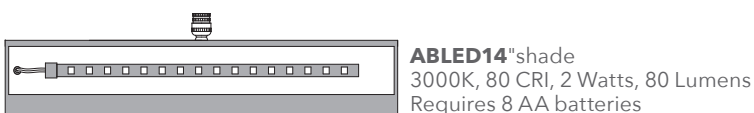
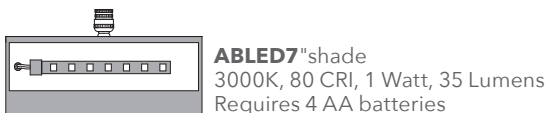

Custom Direct Mount Lighting

Customizing House of Troy Picture Lights.

We are often asked for custom versions of existing products, especially picture lights. Picture Lights are easily adapted to lighting book cases and display areas. We have developed hardware to mount through any hard surface. These products are designed as cord and plug items and will require a receptacle to plug them into behind the soffit. Call our Customer Service department at 800-428-5367 for assistance in designing your direct mount product.



CD-T24-81



CD-SL16-51

Illuminate bookshelves with our Slim-line Library Lighting. The slim lamp profile is designed for interiors where reduced lamp visibility is desired.

Slim-line™ Styles

Mounting Options

Arm Styles

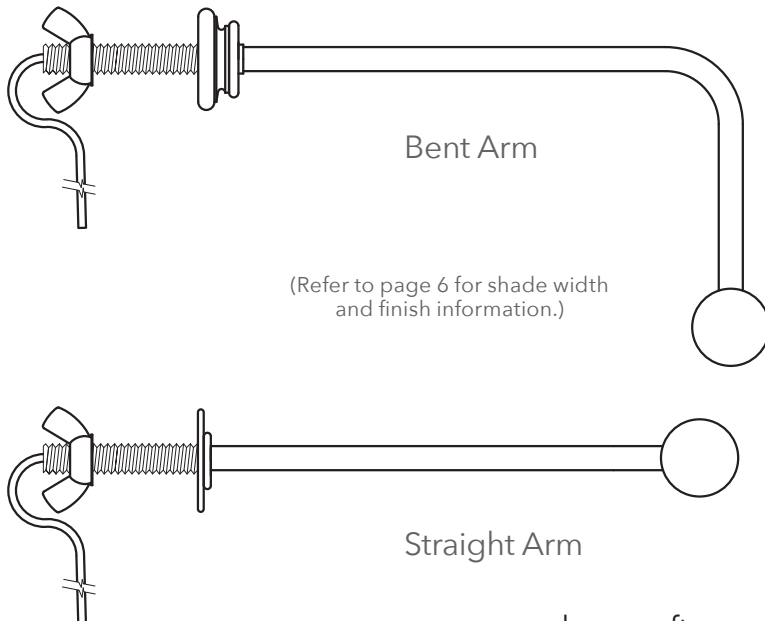



CD-DL10 -OB

Classic style lamps are an effective way to enhance traditional decor in either a residential or commercial setting.



Classic Styles

Mounting Options

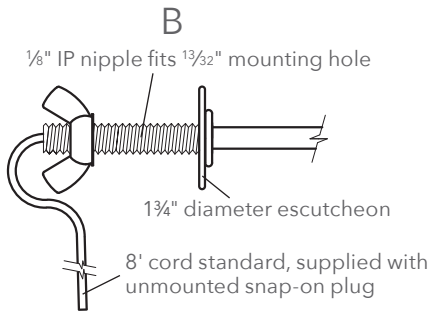
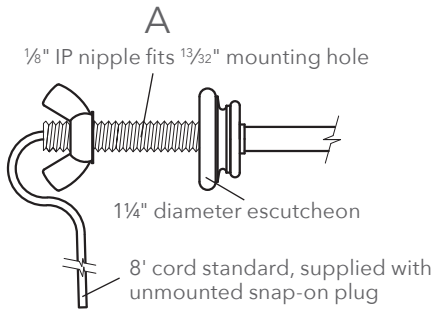

Arm & Shade Styles

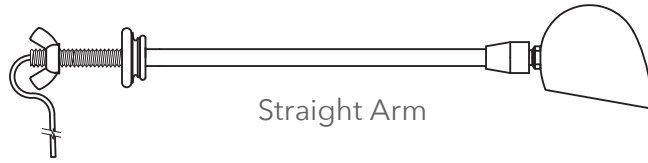

Traditional Shade
(Refer to page 20 for shade width and finish options.)

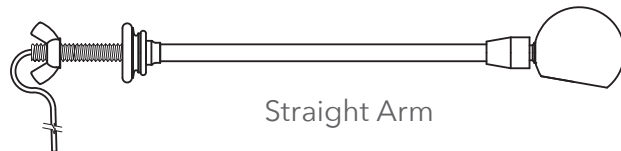

Contemporary Shade
(Refer to page 22 for shade width and finish options.)

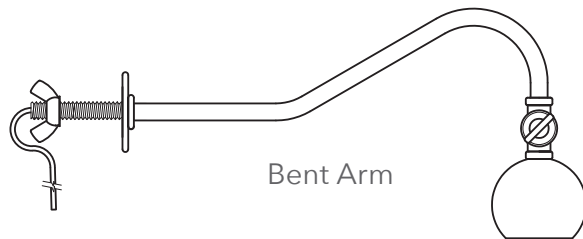

PL Shade
(Refer to page 54 for shade width and finish options.)

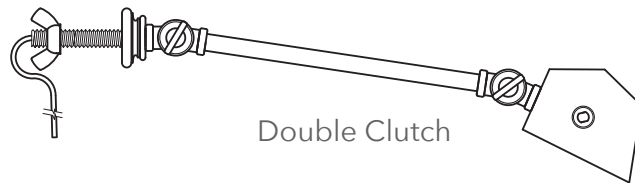

DL Shade
(Refer to page 55 for shade width and finish options.)

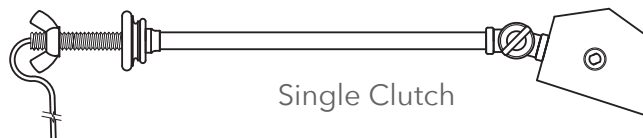

Floor, Table, and Wall Lamp Collections

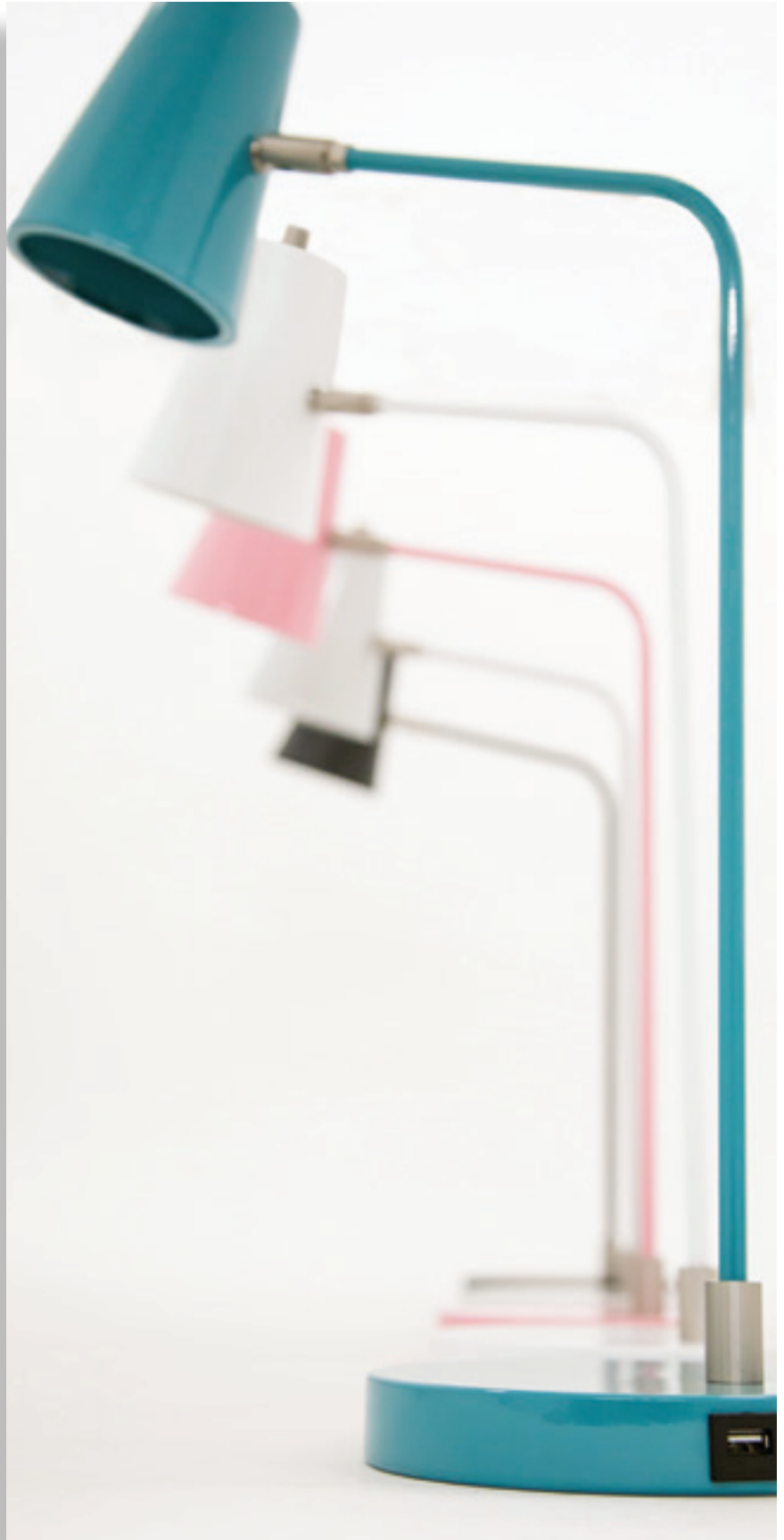

House of Troy designs and builds portable lamps with task in mind. Integrated light sources, additional adjustability, and USB ports in bases add functionality to our product designs.

Addison



Addison pharmacy lamps are classic metal shaded task lamps. Easy adjustment points offer multiple angles from which to focus light.

FLOOR LAMPS

Height: Adjusts 48" to 58"
Extension: 27"
Base: 10" Diameter
Bulb: 75W Type A
Switch: On Socket
Shade: 5" x 8"



AD400-SN
Finish: Satin Nickel
Cord: 10' Clear



AD400-OB
Finish: Oil Rubbed Bronze
Cord: 10' Brown



AD400-AB
Finish: Antique Brass
Cord: 10' Brown

Addison

Height: 5"
Extension: 27"
Backplate: 5" Diameter
Bulb: 75W Type A
Switch: On Socket
Shade: 5" x 8"
Cord: 10' Clear
30" Cord Cover

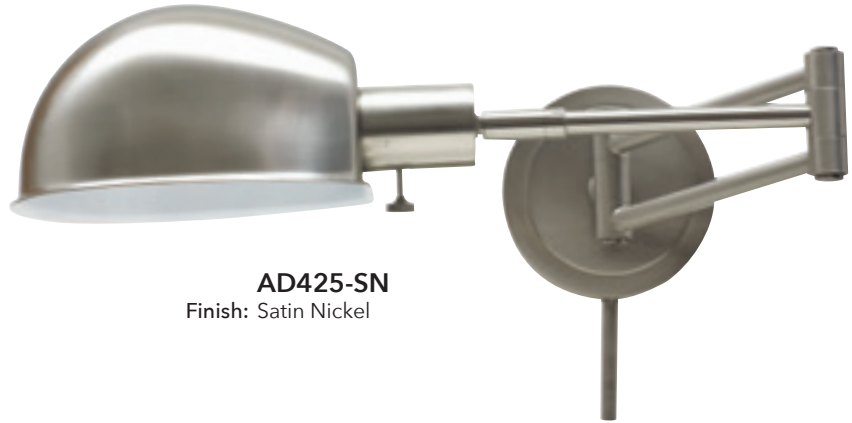

AD425-SN
Finish: Satin Nickel

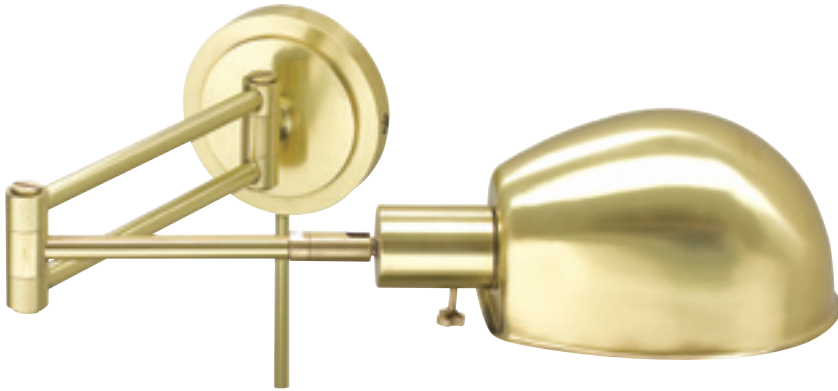

AD425-AB
Finish: Antique Brass



AD425-OB
Finish: Oil Rubbed Bronze

WALL/TABLE LAMPS

Height: Adjusts 24" to 32"
Extension: 27"
Base: 8" Diameter
Bulb: 75W Type A
Switch: On Socket
Shade: 5" x 8"



AD450-AB
Finish: Antique Brass
Cord: 10' Brown



AD450-SN
Finish: Satin Nickel
Cord: 10' Clear



AD450-OB
Finish: Oil Rubbed Bronze
Cord: 10' Brown

Averill

Height: Adjusts 52" to 66"
Base: 11" Diameter
Bulb: Two 100W Type A
Switch: Twin Pull
Shade: 15" x 17" x 10½"



AV100-PN
Finish: Polished Nickel
Shade: White Linen Hardback
Cord: 10' Clear

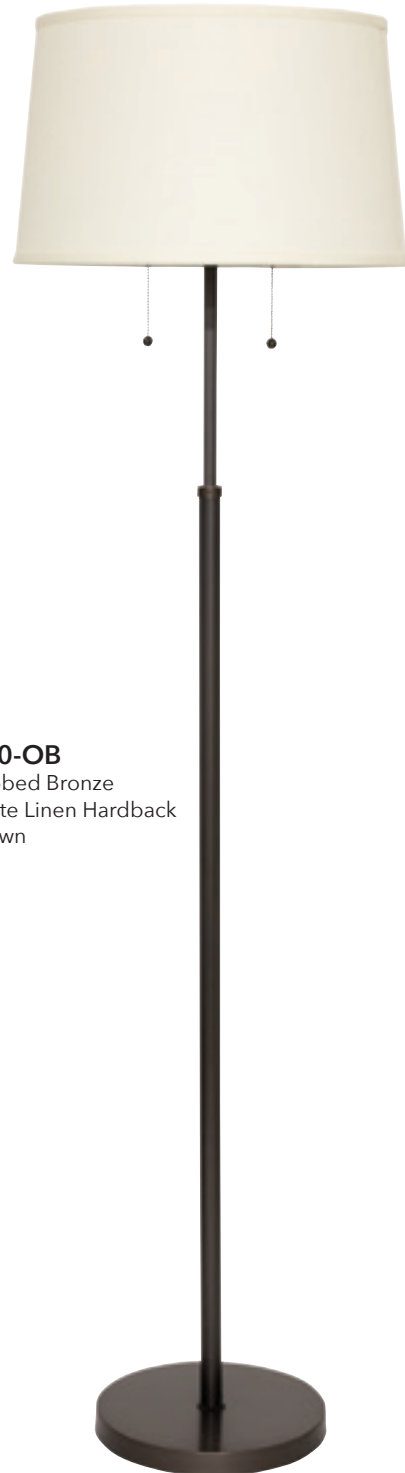

AV100-OB
Finish: Oil Rubbed Bronze
Shade: Off-white Linen Hardback
Cord: 10' Brown

FLOOR LAMPS

Height: Adjusts 58" to 72"
Base: 11" Diameter
Bulb: Two 100W Type A
Switch: Twin Pull
Shade: 15" x 17" x 10½"



AV101-OB
Finish: Oil Rubbed Bronze
Shade: Off-white Linen Hardback
Cord: 10' Brown



AV101-PN
Finish: Polished Nickel
Shade: White Linen Hardback
Cord: 10' Clear

Bennington



Bennington is a classic English candlestick lamp available in twin pull, bridge, and swing arm variations.

FLOOR LAMPS

Height: 63"
Base: 10"
Bulb: (2) 100W medium
Switch: Twin Pull
Shade: 12" x 17" x 10½"



B500-BPN
Finish: Black with Polished Nickel
Shade: White Linen Hardback
Cord: 10' Clear



B500-BWB
Finish: Black with Weathered Brass
Shade: Off-white Linen Hardback
Cord: 10' Brown



B500-WB
Finish: Weathered Brass
Shade: Off-white Linen Hardback
Cord: 10' Brown

Bennington

Height: 61"
Extension: 20¾"
Base: 10"
Bulb: 150W 3-way
Switch: On Socket
Shade: 8½" × 13½" × 11"



B501-WB
Finish: Weathered Brass
Shade: Off-white Linen
Hardback
Cord: 10' Brown

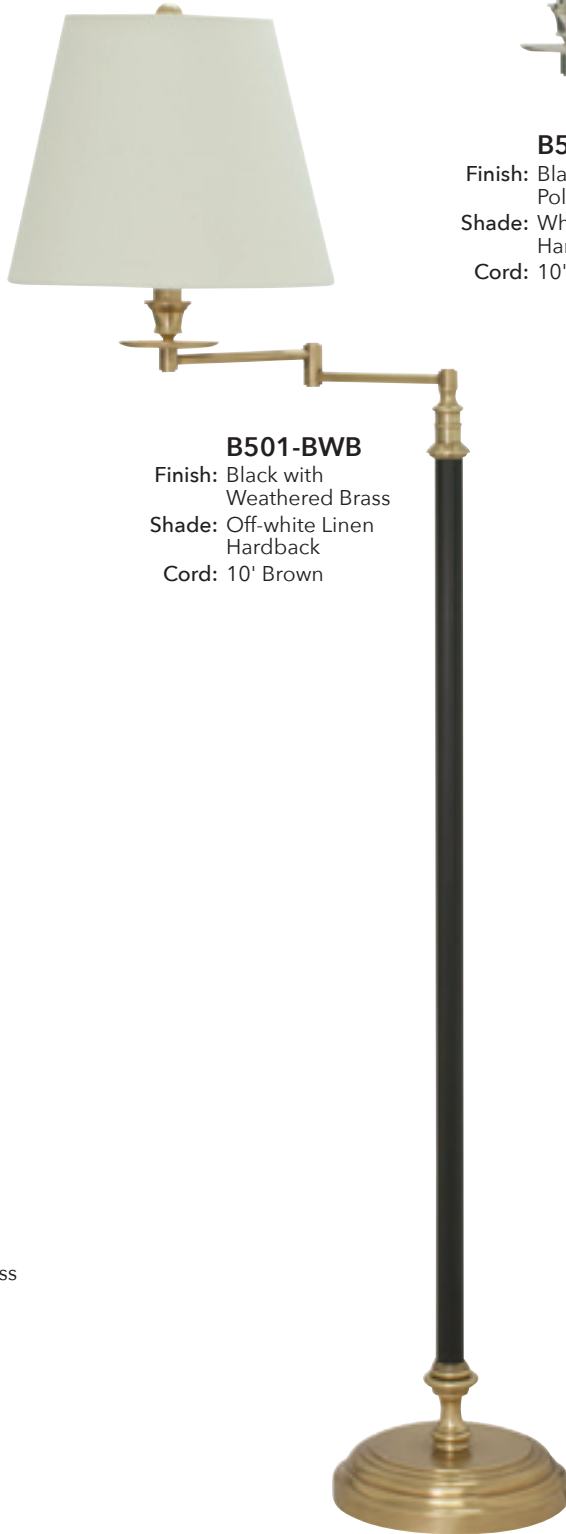

B501-BWB
Finish: Black with
Weathered Brass
Shade: Off-white Linen
Hardback
Cord: 10' Brown



B501-BPN
Finish: Black with
Polished Nickel
Shade: White Linen
Hardback
Cord: 10' Clear

FLOOR LAMPS

Height: 58"
Extension: 15"
Base: 10"
Bulb: 150W 3-way
Switch: On Socket
Shade: 8½" x 13½" x 11"

B502-WB
Finish: Weathered Brass
Shade: Off-white Linen
Hardback
Cord: 10' Brown



Bennington

Height: 27½"
Base: 7"
Bulb: (2) 100W medium
Switch: Twin Pull
Shade: 12" × 17" × 10½"



B550-WB
Finish: Weathered Brass
Shade: Off-white Linen
Hardback
Cord: 10' Brown



B550-BWB
Finish: Black with
Weathered Brass
Shade: Off-white Linen
Hardback
Cord: 10' Brown



B550-BPN
Finish: Black with
Polished Nickel
Shade: White Linen Hardback
Cord: 10' Clear

TABLE LAMPS

Height: 28½"
Extension: 15"
Base: 7"
Bulb: 150W 3-way
Switch: On Socket
Shade: 8½" × 12½" × 9½"



B551-BWB
Finish: Black with
Weathered Brass
Shade: Off-white Linen
Hardback
Cord: 10' Brown



B551-WB
Finish: Weathered Brass
Shade: Off-white
Linen Hardback
Cord: 10' Brown



B551-BPN
Finish: Black with
Polished Nickel
Shade: White Linen
Hardback
Cord: 10' Clear

Burke



The square shaded Burke floor lamp illuminates with great style. The adjustable arm adds function to this simple and elegant modern design.

FLOOR LAMPS

Height: Adjusts 51" to 66"
Base: 10" x 10"
Bulbs: Two 100W Type A
Switch: Pull Chain
Shade: 15" x 17" x 10"



BU200-PN
Finish: Polished Nickel
Shade: White Linen Hardback
Cord: 10' Clear

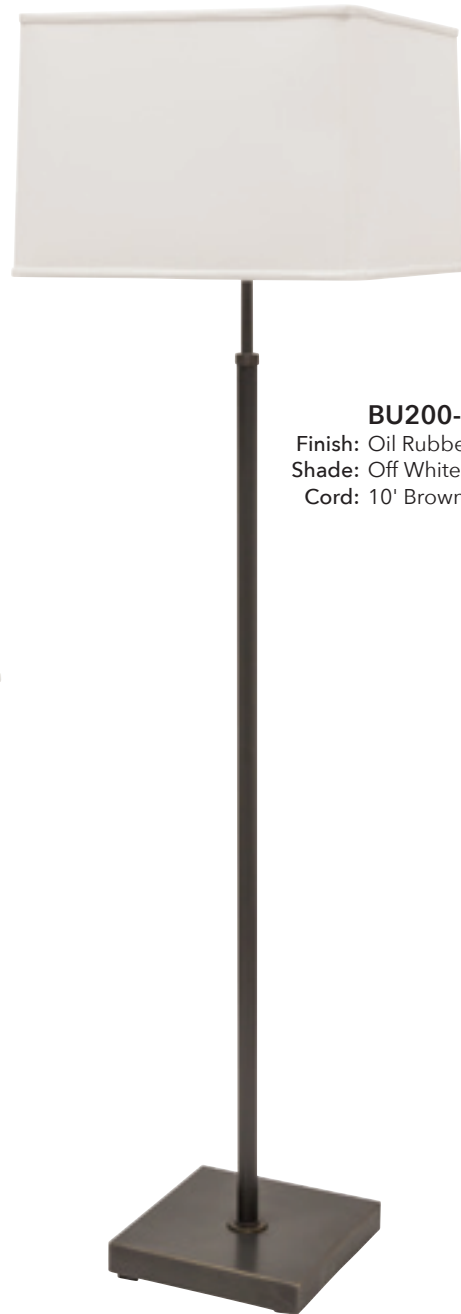

BU200-OB
Finish: Oil Rubbed Bronze
Shade: Off White Linen Hardback
Cord: 10' Brown

Cavendish



Savannah Brown Photography on location at Field Guide, Stowe VT

Cavendish floor and table lamps in mixed metal finishes are a nod to the mid-century modern genre with distinctly twenty first century integrated LED light output.

FLOOR/TABLE LAMPS

Height: Adjusts 42" to 55½"
Extension: 12"
Base: 11"
LED: Integrated 3000K, 80 CRI, 6 Watts,
500 Lumens
Switch: Touch Dimmer on Shade
Shade: 3" × 5¾"
Cord: 10' Clear with Plug-in Driver

C300-WB/BLK
Finish: Weathered Brass
with Black Accents



C300-WB/WT
Finish: Weathered Brass
with White Accents

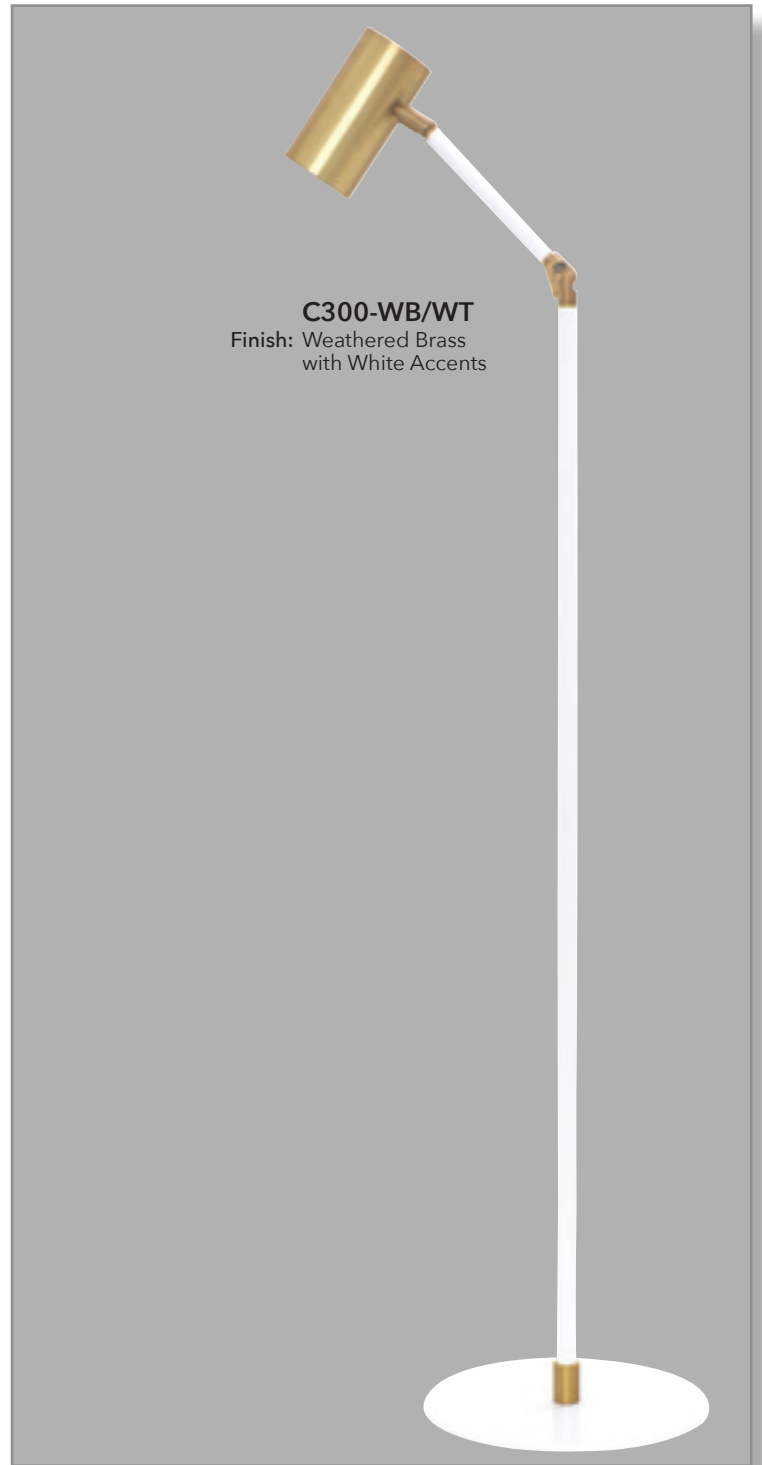

Cavendish

Height: 21"
Extension: 13½"
Base: 8"
LED: Integrated 3000K, 80 CRI, 6 Watts,
500 Lumens
Switch: Touch Dimmer on Shade
Shade: 3" × 5¾"
Cord: 10' Clear with Plug-in Driver



C350-WB/BLK
Finish: Weathered Brass with
Black Accents



C350-WB/WT
Finish: Weathered Brass
with White Accents



The Club lamps, of petite stature, are perfect for small spaces. The classic style will look great in any traditional setting.

Club

Height: Adjusts 45" to 59"
Extension: 19½"
Base: 12" Round
Bulb: One 100W 3-way
Switch: On Socket
Shade: 6½" x 13" x 10"



CL200-OB
Finish: Oil Rubbed Bronze
Shade: Off-white Softback
Cord: 10' Brown



CL200-AS
Finish: Antique Silver
Shade: White Softback
Cord: 10' Clear



CL200-AB
Finish: Antique Brass
Shade: Off-white Softback
Cord: 10' Brown

FLOOR LAMPS

Height: Adjusts 45" to 59"
Base: 12" Round
Bulb: One 100W 3-way
Switch: On Socket
Shade: 6½" x 13" x 10"

CL201-AB

Finish: Antique Brass
Shade: Off-white Softback
Cord: 10' Brown



CL201-PB

Finish: Polished Brass
Shade: Off-white Softback
Cord: 10' Brown



CL201-AS

Finish: Antique Silver
Shade: White Softback
Cord: 10' Clear



CL201-OB

Finish: Oil Rubbed Bronze
Shade: Off-white Softback
Cord: 10' Brown



Club

Height: Adjusts 45" to 59"

Base: 10" Diameter

Bulb: One 100W 3-way

Switch: On Socket

Shade: 6½" x 13" x 10"

Table: 12" Diameter

Height 24"



CL202-OB

Finish: Oil Rubbed Bronze

Shade: Off-white Softback

Cord: 10' Brown



CL202-AS

Finish: Antique Silver

Shade: White Softback

Cord: 10' Clear

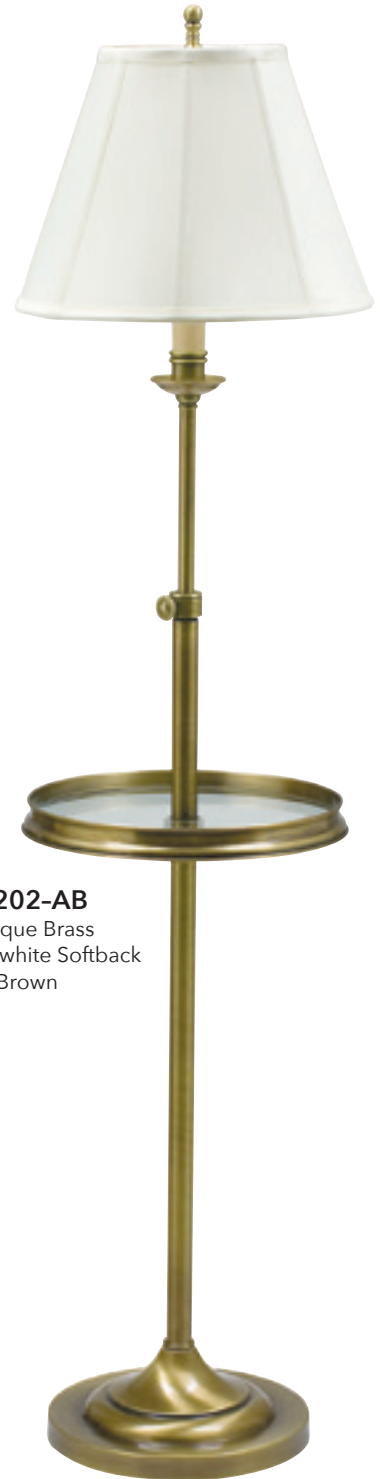

CL202-AB

Finish: Antique Brass

Shade: Off-white Softback

Cord: 10' Brown

FLOOR/WALL LAMPS

Height: 17¾"
Extension: 20½"
Backplate: 2¾" x 5¾"
Bulb: One 100W 3-way
Switch: On Socket
Shade: 6½" x 13" x 10"
Cord: 10' Clear
30" Cord Cover



CL225-AS
Finish: Antique Silver
Shade: White Softback



CL225-AB
Finish: Antique Brass
Shade: Off-white Softback



CL225-OB
Finish: Oil Rubbed Bronze
Shade: Off-white Softback

Cover plate provided for standard junction box when necessary, as shown on CL225-AB.

Club

Height: Adjusts 25" to 31"
Base: 7" Round
Bulb: One 100W 3-way
Switch: On Socket
Shade: 6½" × 13" × 10"



CL250-OB
Finish: Oil Rubbed Bronze
Shade: Off-white Softback
Cord: 10' Brown



CL250-AB
Finish: Antique Brass
Shade: Off-white Softback
Cord: 10' Brown



CL250-AS
Finish: Antique Silver
Shade: White Softback
Cord: 10' Clear

TABLE LAMPS

Height: 25"
Extension: 19½"
Base: 7" Round
Bulb: One 100W 3-way
Switch: On Socket
Shade: 6½" × 13" × 10"



CL251-AB
Finish: Antique Brass
Shade: Off-white Softback
Cord: 10' Brown



CL251-OB
Finish: Oil Rubbed Bronze
Shade: Off-white Softback
Cord: 10' Brown



CL251-AS
Finish: Antique Silver
Shade: White Softback
Cord: 10' Clear

Coach



The Coach collection offers an economic choice for your space. Price point is low, quality is high.

FLOOR LAMPS

Height: 61"
Base: 10" Diameter
Bulb: One 150W 3-way
Switch: On Socket
Shade: 15" x 16" x 10"



CH800-AB
Finish: Antique Brass
Shade: Off-white Silk Softback
Cord: 10' Gold



CH800-AS
Finish: Antique Silver
Shade: White Silk Softback
Cord: 10' Silver



CH800-OB
Finish: Oil Rubbed Bronze
Shade: Off-white Silk Softback
Cord: 10' Brown

Coach

Height: Adjusts 35 ½" to 52 ½"
Extension: 14"
Base: 10" Diameter
Bulb: One 60W Type A
Switch: On Socket
Shade: Metal 7" x 4" x 3 ¼"

NOTE: Cord exits from adjustment arm.



CH825-AB
Finish: Antique Brass
Cord: 10' Gold



CH825-OB
Finish: Oil Rubbed Bronze
Cord: 10' Brown



CH825-AS
Finish: Antique Silver
Cord: 10' Silver

FLOOR/TABLE LAMPS

Height: 30 1/4"
Base: 8" Diameter
Bulb: One 150W 3-way
Switch: On Socket
Shade: 14" x 15" x 10"



CH850-OB
Finish: Oil Rubbed Bronze
Shade: Off-white Silk Softback
Cord: 10' Brown



CH850-AB
Finish: Antique Brass
Shade: Off-white Silk Softback
Cord: 10' Gold



CH850-AS
Finish: Antique Silver
Shade: White Silk Softback
Cord: 10' Silver

Coach



CH876-AB

Finish: Antique Brass
Height: 12½"
Base: 6" x 4" Rectangle
Bulb: One 60W Type A
Switch: In-Line
Shade: Off-white Hardback
(6" x 4") x (10" x 6") x 7"
Cord: 10' Gold



CH880-OB

Finish: Oil Rubbed Bronze
Height: 15"
Base: 6" x 4" Rectangle
Bulb: Two 60W-B10 Candelabra
Switch: In-Line
Shade: Off-white Hardback
(4" x 6") x (8" x 6") x 6"
Cord: 10' Brown



CH878-AB

Finish: Antique Brass
Height: 12"
Base: 4¾" Diameter
Bulb: One 60W-B10 Candelabra
Switch: In-Line
Shade: Off-white Hardback
4" x 6" x 6"
Cord: 10' Gold



CH875-OB

Finish: Oil Rubbed Bronze
Height: 14"
Base: 5¼" Diameter
Bulb: One 60W Type A
Switch: In-Line
Shade: Off-white Hardback
6" x 9" x 7"
Cord: 10' Brown

Crown Point



The Crown Point series allows for height adjustment and a swing arm. The down-bridge style shade is great for focusing light on your task.

Crown Point

Height: Adjusts 38" to 63"
Extension: 18"
Base: 10"
Bulb: 100W 3-way
Switch: On Socket
Shade: 10" x 12" x 8"



CR700-AB

Finish: Antique Brass
Shade: Off-white Linen Hardback
Cord: 10' Brown



CR700-SN

Finish: Satin Nickel
Shade: White Linen Hardback
Cord: 10' Clear



CR700-OB

Finish: Oil Rubbed Bronze
Shade: Off-white Linen Hardback
Cord: 10' Brown

FLOOR/WALL LAMPS

Height: Adjusts 8" to 18"
Extension: 18"
Backplate: 4½" x 6½"
Bulb: 100W 3-way
Switch: On Socket
Shade: 10" x 12" x 8"
Cord: 8' Clear

Plug-in Only



CR725-AB
Finish: Antique Brass
Shade: Off-white Linen
Hardback



CR725-OB
Finish: Oil Rubbed Bronze
Shade: Off-white Linen
Hardback



CR725-SN
Finish: Satin Nickel
Shade: White Linen
Hardback

Danby

Height: 65"
Extension: 22"
Base: 11¾"
Bulb: 150W 3-way
Switch: On Socket
Shade: 17" x 18" x 10"



D300-AB

Finish: Antique Brass
Shade: Off-white Linen Hardback
Cord: 10' Brown



D300-PN

Finish: Polished Nickel
Shade: Off-white Linen Hardback
Cord: 10' Clear



D300-OB

Finish: Oil Rubbed Bronze
Shade: Off-white Linen Hardback
Cord: 10' Brown

FLOOR LAMPS

Height: 65"
Extension: 17"
Bulb: 100W 3-way
Base: 11¾"
Switch: On Socket
Shade: Clear Seedy Glass
8" x 8" x 10"

D300-AB-G
Finish: Antique Brass
Cord: 10' Brown



D300-OB-G
Finish: Oil Rubbed Bronze
Cord: 10' Brown

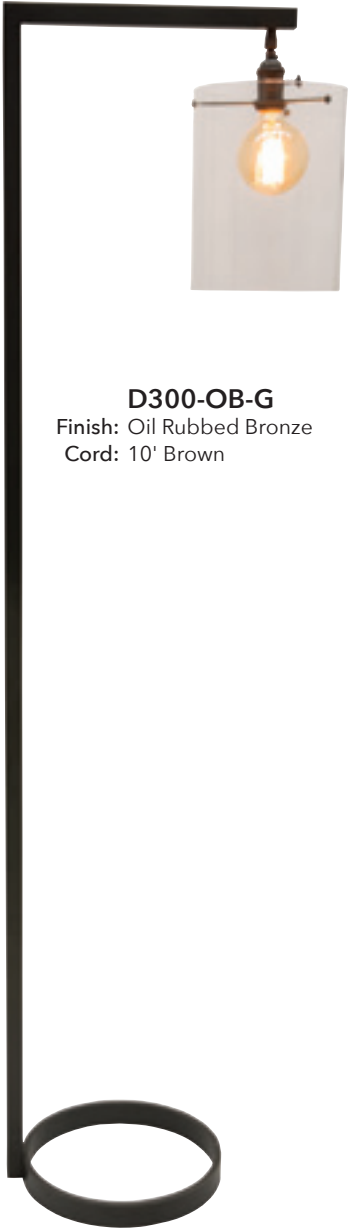

D300-PN-G
Finish: Polished Nickel
Cord: 10' Clear



Danby

Height: 32"
Extension: 17½"
Base: 9½" Diameter
Bulb: 150W 3-way
Switch: On Socket
Shade: 13" x 14" x 9"



D350-AB
Finish: Antique Brass
Shade: Off-white Linen Hardback
Cord: 10' Brown



D350-PN
Finish: Polished Nickel
Shade: White Linen Hardback
Cord: 10' Clear



D350-OB
Finish: Oil Rubbed Bronze
Shade: Off-white Linen Hardback
Cord: 10' Brown

TABLE LAMPS

Height: 32"
Extension: 14½"
Base: 9½" Diameter
Bulb: 100W 3-way
Switch: On Socket
Shade: Clear Seedy Glass
8" x 8" x 10"



D350-AB-G
Finish: Antique Brass
Cord: 10' Brown

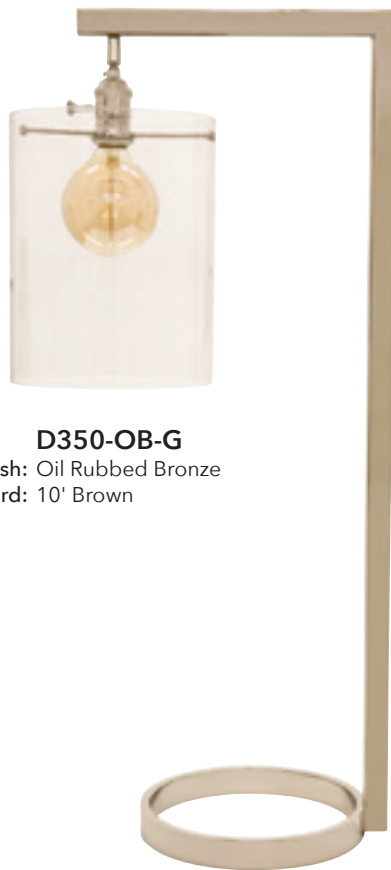

D350-OB-G
Finish: Oil Rubbed Bronze
Cord: 10' Brown



D350-PN-G
Finish: Polished Nickel
Cord: 10' Clear

Delta



A classic reading light with a solid-state LED light source. The Delta series packs a lot of light into a small shade. Easy dimmable switching on shade.

FLOOR LAMPS

Height: Adjusts 37½" to 49½"
Extension: 20"
Base: 10"
LED: Integrated 3000K, 80 CRI, 6 Watts, 500 Lumens
Switch: Touch Dimmer on Shade
Shade: 2" x 4"
Cord: 10' Clear with Plug-in Driver



D100-SN
Finish: Satin Nickel



D100-AB
Finish: Antique Brass



D100-OB
Finish: Oil Rubbed Bronze

Delta

Height: 18"
Extension: 18"
Base: 7"
LED: Integrated 3000K, 80 CRI,
6 Watts, 500 Lumens
Switch: Touch Dimmer on Shade
Shade: 2" x 4"
Cord: 10' Clear with Plug-in Driver



D150-OB
Finish: Oil Rubbed Bronze



D150-AB
Finish: Antique Brass



D150-SN
Finish: Satin Nickel

DESK/WALL LAMPS

Height: 5½"
Extension: 21"
Backplate: 5½"
LED: Integrated 3000K, 80 CRI,
6 Watts, 500 Lumens
Switch: Touch Dimmer on Shade
Shade: 2" × 4"
Cord: 10' Clear with Plug-in Driver,
with 30" cord cover

Plug-in Only



D175-AB
Finish: Antique Brass



D175-OB
Finish: Oil Rubbed Bronze



D175-SN
Finish: Satin Nickel

Essex



Essex floor and table lamps are designed to provide maximum light output using multiple bulb configurations. The classic look will fit any traditional or transitional décor.

FLOOR LAMPS

Height: 69"
Base: 10"
Bulb: 150W Type A
Switch: On Column
Shade: White Glass
15 3/4" x 6"



E900-AB
Finish: Antique Brass
Cord: 10' Brown



E900-OB
Finish: Oil Rubbed Bronze
Cord: 10' Brown



E900-SN
Finish: Satin Nickel
Cord: 10' Clear

Essex

Height: 57"
Base: 10"
Bulbs: Two 100W Type A
Switch: Pull Chain
Shade: Cream Linen Hardback
17" x 18" x 11"



E901-AB
Finish: Antique Brass
Cord: 10' Brown



E901-OB
Finish: Oil Rubbed Bronze
Cord: 10' Brown



E901-SN
Finish: Satin Nickel
Cord: 10' Clear

FLOOR LAMPS

Height: 56"
Base: 10"
Bulb: 150W 3-way
Switch: On Socket
Shade: Cream Linen Hardback
17" x 18" x 11"
Table: 12" diameter
Table height 24"



E902-OB
Finish: Oil Rubbed Bronze
Cord: 10' Brown



E902-AB
Finish: Antique Brass
Cord: 10' Brown



E902-SN
Finish: Satin Nickel
Cord: 10' Clear



Essex

Height: 63"
Base: 10"
Bulbs: Standard Six-way
One 150W 3-way
Three 75W Type A
Switch: On Column
Shade: Cream Linen Hardback
17" x 18" x 11"



E903-AB
Finish: Antique Brass
Cord: 10' Brown



E903-OB
Finish: Oil Rubbed Bronze
Cord: 10' Brown



E903-SN
Finish: Satin Nickel
Cord: 10' Clear

FLOOR LAMPS

Height: 61"
Extension: 23"
Base: 10"
Bulb: 150W 3-way
Switch: On Socket
Shade: Cream Linen Hardback
14" x 15" x 10"



E904-AB
Finish: Antique Brass
Cord: 10' Brown



E904-OB
Finish: Oil Rubbed Bronze
Cord: 10' Brown



E904-SN
Finish: Satin Nickel
Cord: 10' Clear

Essex

Height: 30"
Base: 8"
Bulbs: Two 60W Type A
Switch: Pull Chain
Shade: Cream Linen Hardback
14" x 15" x 10"

E951-SN
Finish: Satin Nickel
Cord: 10' Clear



E951-OB
Finish: Oil Rubbed Bronze
Cord: 10' Brown



E951-AB
Finish: Antique Brass
Cord: 10' Brown





The base on the Fairfax pharmacy lamp is flat and narrow, meant to be tucked under a couch or bed. Height adjustment offers flexibility for light placement.

Fairfax

Height: Adjusts 36" to 53"
Extension: 13½"
Base: 9" x 12" x 1¾"
Bulb: One 60T10
Switch: On Shade
Shade: 6½" x 3" x 6"

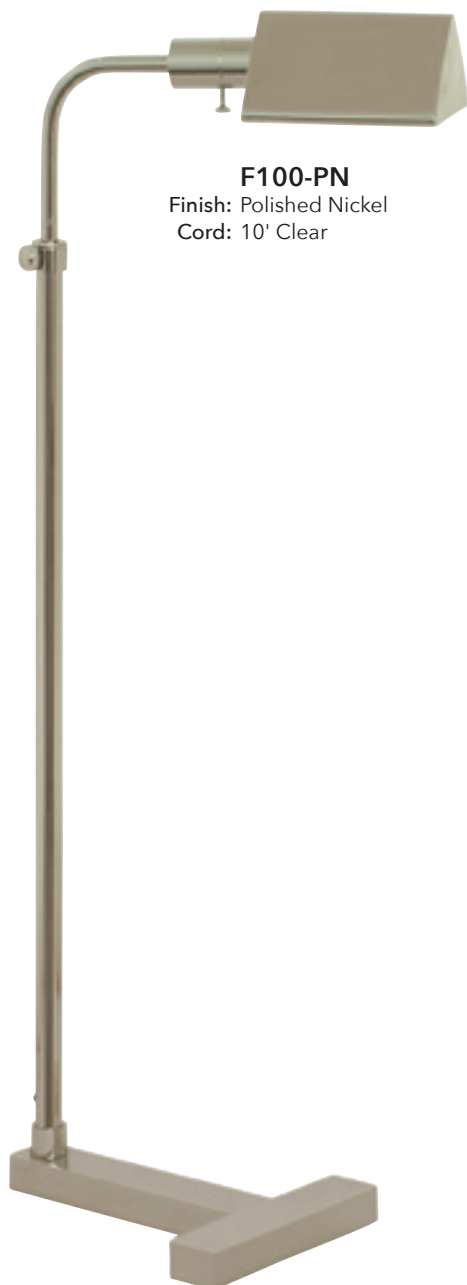

F100-PN
Finish: Polished Nickel
Cord: 10' Clear

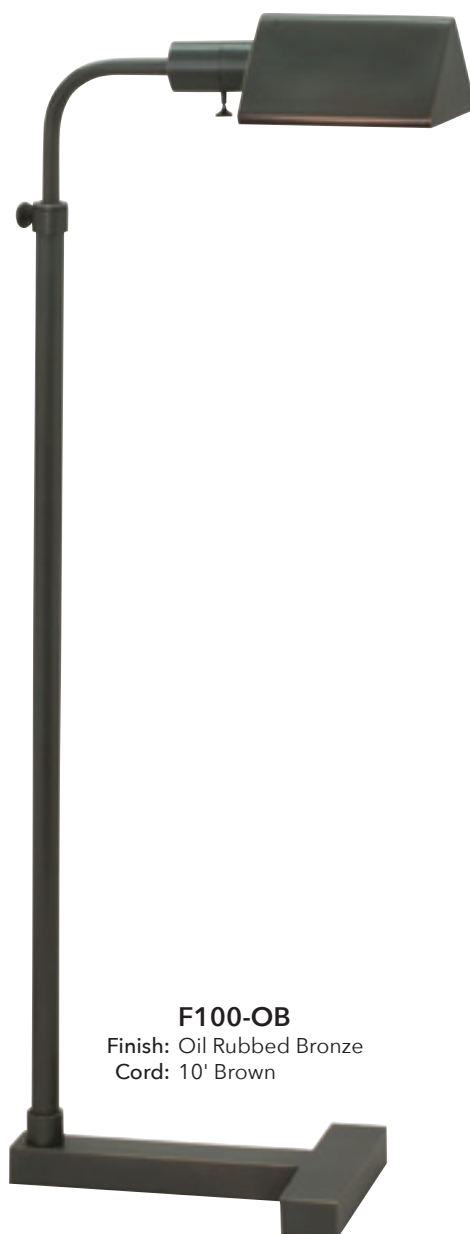

F100-OB
Finish: Oil Rubbed Bronze
Cord: 10' Brown



F100-AB
Finish: Antique Brass
Cord: 10' Brown



Diffused light and full range dimming are features of the Franklin series. The table lamp is offered with a USB port for easy charging access.

Franklin

Height: 64"
Base: 10"
Bulb: 150W Type A
Switch: Full Range Dimmer on Column
Shade: 19" x 19½" x 10" with Diffuser



FR700-OB

Finish: Oil Rubbed Bronze
Shade: Off-white Linen
Hardback
Cord: 10' Brown



FR700-PN

Finish: Polished Nickel
Shade: White Linen Hardback
Cord: 10' Clear

FLOOR LAMPS

Height: 60"
Extension: 25½"
Base: 10"
Bulb: 150W Type A
Switch: Full Range Dimmer
Shade: 15" × 15½" × 7½" with Diffuser



FR701-OB

Finish: Oil Rubbed Bronze
Shade: Off-white Linen
Hardback
Cord: 10' Brown



FR701-PN

Finish: Polished Nickel
Shade: White Linen
Hardback
Cord: 10' Clear

Franklin

Height: 27"

Base: 7" with USB port

Bulb: 150W Type A

Switch: Full Range Dimmer

Shade: 15" x 15½" x 7½" with Diffuser



FR750-OB

Finish: Oil Rubbed Bronze

Shade: Off-white Linen Hardback



FR750-PN

Finish: Polished Nickel

Shade: White Linen Hardback

Generation 1



The Generation 1 halogen series of pharmacy lamps use a GU10 encapsulated halogen bulb and are fully dimmable. These powder coated lamps are durable and adjustable.

Generation 1

Height: Adjusts 32½" to 45"
Extension: 11"
Base: 10" Diameter
Bulb: One 50W GU10 (Included)
Switch: Full Range Dimmer on Socket
Shade: 6½" x 1½"



G100-GT

Finish: Granite
Cord: 10' Black



G100-CHB

Finish: Chestnut Bronze
Cord: 10' Brown

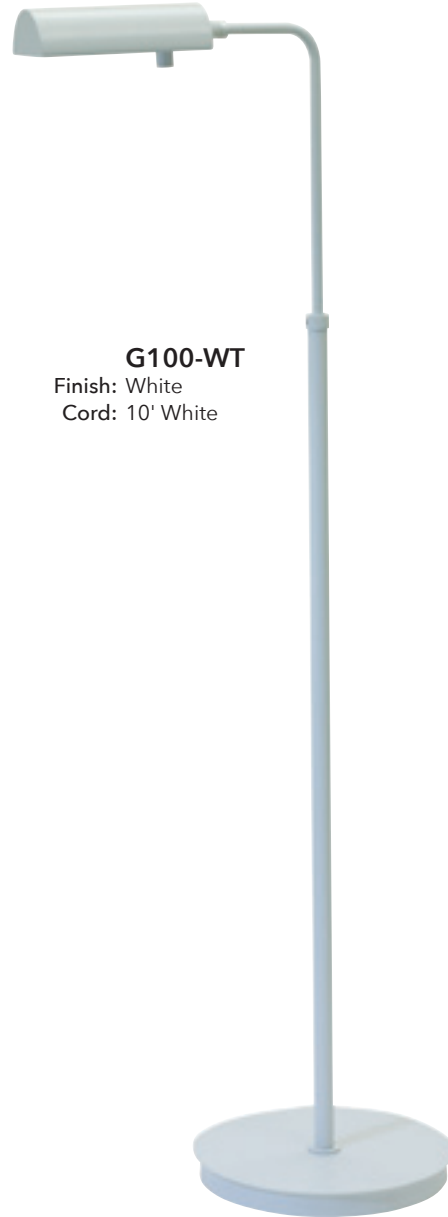

G100-WT

Finish: White
Cord: 10' White

FLOOR/DESK LAMPS

Height: Adjusts 11½" to 17½"
Extension: 25"
Base: 6" Diameter
Bulb: One 50W GU10 (Included)
Switch: Full Range Dimmer on Socket
Shade: 6½" × 1½"



G150-CHB
Finish: Chestnut Bronze
Cord: 10' Brown



G150-GT
Finish: Granite
Cord: 10' Black



G150-WT
Finish: White
Cord: 10' White

Generation 1

Height: 5¼"
Extension: 20½"
Backplate: 5¼" Diameter
Bulb: One 50W GU10 (Included)
Switch: Full Range Dimmer in Shade
Shade: 6½" × 1½"
Cord: 10' Ivory
30" Cord Cover



G175-GT
Finish: Granite



G175-WT
Finish: White

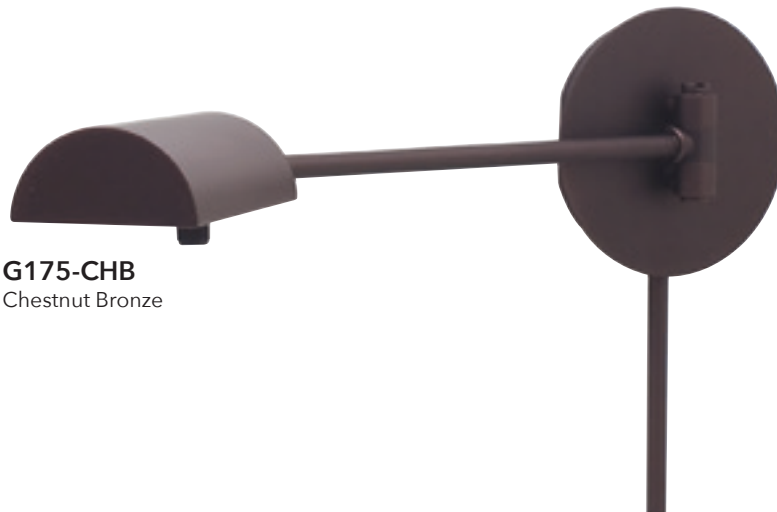

G175-CHB
Finish: Chestnut Bronze

Generation 2



*Generation 2 fabric shaded
incandescent table and
floor models are controlled
with a full range
dimmer on the socket.*

Generation 2

Height: Adjusts 47" to 60"
Extension: 15¼"
Base: 10" Diameter
Bulb: One 150W Type A
Switch: Full Range Dimmer on Socket
Shade: 11" x 13" x 9"



G200-CHB

Finish: Chestnut Bronze
Shade: Off-white Linen
Cord: 10' Brown



G200-GT

Finish: Granite
Shade: White Linen
Cord: 10' Black

FLOOR/TABLE LAMPS

Height: 25½"
Base: 6" Diameter
Bulb: One 100W Type A
Switch: Full Range Dimmer on Socket
Shade: 8½" × 11½" × 9"



G250-CHB
Finish: Chestnut Bronze
Shade: Off-White Linen Hardback
Cord: 10' Brown



G250-GT
Finish: Granite
Shade: White Linen Hardback
Cord: 10' Black

Generation 3



The Generation 3 uses a linear LED configuration for optimal light output. A small footprint on the floor base makes this a great choice for small spaces.

FLOOR LAMPS

Height: Adjusts 37" to 46½"
Extension: 17"
Base: 6" x 7¼"
LED: Integrated 3000K, 85 CRI,
4.5 Watts, 500 Lumens
Switch: On Shade
Shade: 11¼" x ¾"

G300-GT
Finish: Granite
Cord: 10' Black



G300-BLK
Finish: Black
Cord: 10' Black



G300-WT
Finish: White
Cord: 10' Clear



G300-CHB
Finish: Chestnut Bronze
Cord: 10' Brown



Generation 3

Height: Maximum 22"
Extension: 35"
Base: 6" x 7¼"
LED: Integrated 3000K, 85 CRI,
4.5 Watts, 500 Lumens
Switch: On Shade
Shade: 11¼" x ¾"

G350-WT
Finish: White
Cord: 10' White



G350-GT
Finish: Granite
Cord: 10' Black



G350-BLK
Finish: Black
Cord: 10' Black



G350-CHB
Finish: Chestnut Bronze
Cord: 10' Brown



TABLE/WALL LAMPS

Height: 5"
Extension: 24½"
Backplate: 5" x 5"
LED: Integrated 3000K, 85 CRI,
4.5 Watts, 500 Lumens
Switch: On Shade
Shade: 11¼" x ¾"
Cord: 30" Cord Cover

G375-CHB
Finish: Chestnut Bronze
Cord: 10' Ivory

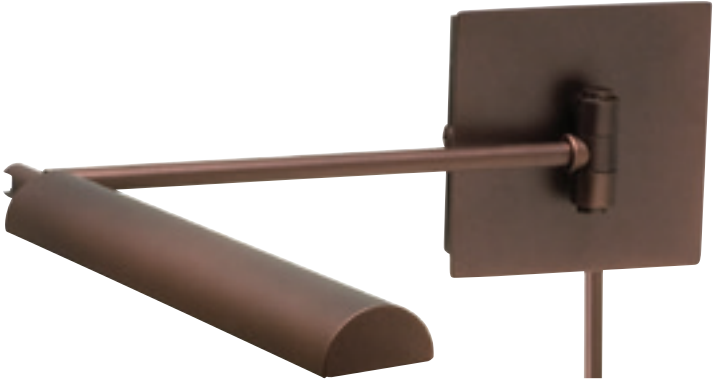

G375-BLK
Finish: Black
Cord: 10' Ivory



G375-WT
Finish: White
Cord: 10' White



G375-GT
Finish: Granite
Cord: 10' Ivory



Generation 4



Savannah Brown Photography on location at Field Guide, Stowe VT

Generation 4 LED series uses chip on board (COB) technology and touch dimming controls. COB's are wide area light emitters, providing better color mixing and lighting effect.

FLOOR LAMPS

Height: Adjusts 37" to 48"
Extension: 15½"
Base: 10"
LED: Integrated 3000K, 80 CRI, 6 Watts, 500 Lumens
Switch: Touch Dimmer on Shade
Shade: 4" x 1¾"
Cord: 10' Clear with Plug-in Driver

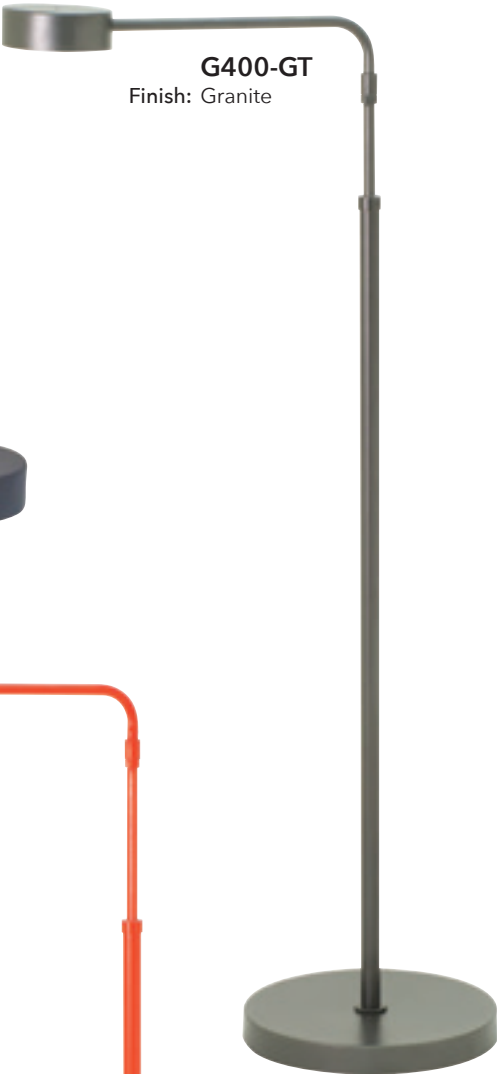

G400-GT
Finish: Granite



G400-ABZ
Finish: Architectural Bronze

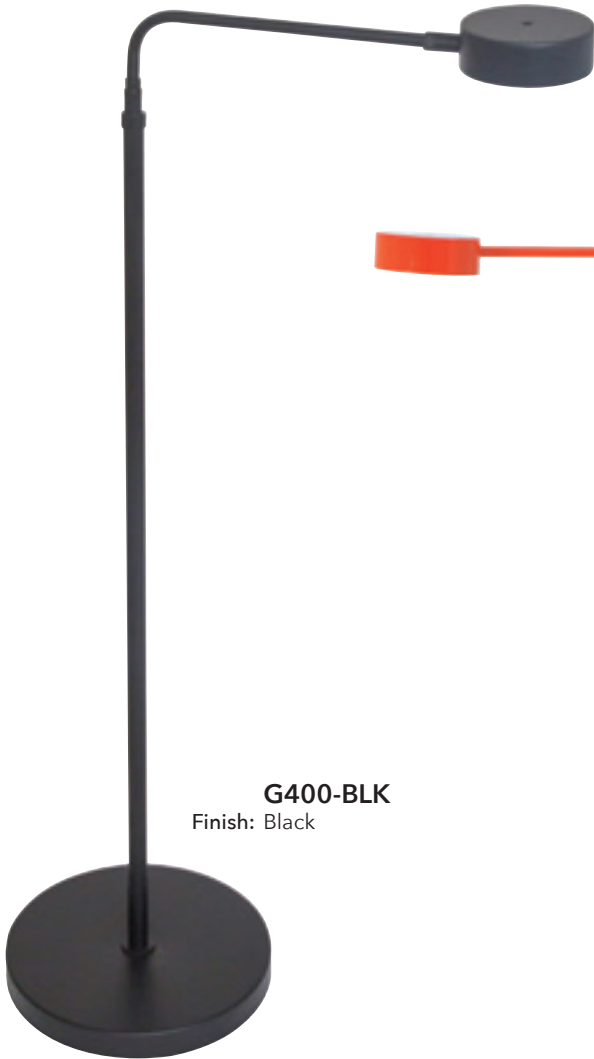

G400-BLK
Finish: Black



G400-BS
Finish: Bittersweet

Generation 4

Height: Adjusts 37" to 48"
Extension: 15½"
Base: 10"
LED: Integrated 3000K, 80 CRI, 6 Watts, 500 Lumens
Switch: Touch Dimmer on Shade
Shade: 4" x 1⅜"
Cord: 10' Clear with Plug-in Driver

G400-NB
Finish: Navy Blue



G400-WT
Finish: White



G400-PG
Finish: Platinum Gray



FLOOR/DESK LAMPS

Height: Adjusts 11" to 16½"
Extension: 22"
Base: 7" with USB port
LED: Integrated 3000K, 80 CRI, 6 Watts, 500 Lumens
Switch: Touch Dimmer on Shade
Shade: 4" x 1¾"
Cord: 10' Clear with Plug-in Driver



G450-BS
Finish: Bittersweet



G450-BLK
Finish: Black



G450-GT
Finish: Granite



G450-ABZ
Finish: Architectural Bronze

Generation 4

Height: Adjusts 11" to 16½"
Extension: 22"
Base: 7" with USB port
LED: Integrated 3000K, 80 CRI, 6 Watts, 500 Lumens
Switch: Touch Dimmer on Shade
Shade: 4" x 1¾"
Cord: 10' Clear with Plug-in Driver



G450-PG
Finish: Platinum Gray



G450-WT
Finish: White



G450-NB
Finish: Navy Blue

DESK/WALL LAMPS

Height: 5"
Extension: 17¾"
Base: 7"
LED: Integrated 3000K, 80 CRI, 6 Watts, 500 Lumens
Switch: Touch Dimmer on Shade
Shade: 4" x 1¾"
Cord: 10' Clear with Plug-in Driver
30" Cord Cover

Plug-in Only



G475-BLK
Finish: Black



G475-GT
Finish: Granite



G475-WH
Finish: White

Generation 4

Plug-in Only

Height: 5"
Extension: 17¾"
Base: 7"
LED: Integrated 3000K, 80 CRI, 6 Watts, 500 Lumens
Switch: Touch Dimmer on Shade
Shade: 4" × 1⅜"
Cord: 10' Clear with Plug-in Driver
30" Cord Cover



Generation 5



Our fifth generation of powder coated task lamps, the Generation 5 uses our latest 800 lumen LED array and is dimmable and adjustable.

Generation 5

Height: Adjusts 42" to 51½"

Base: 6" x 7¼"

Extension: 17"

LED: Integrated 2900K, 96 CRI, 6.8 Watts, 800 Lumens

Switch: On Shade

Shade: 2½" x 5"

Cord: 10' Clear with Plug-in Driver

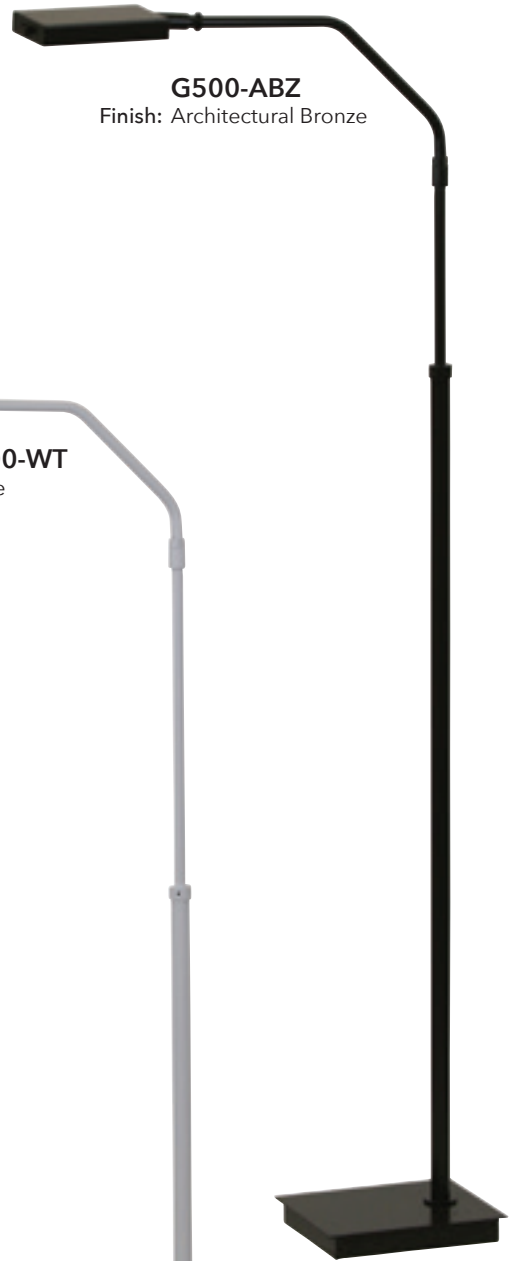

G500-ABZ

Finish: Architectural Bronze

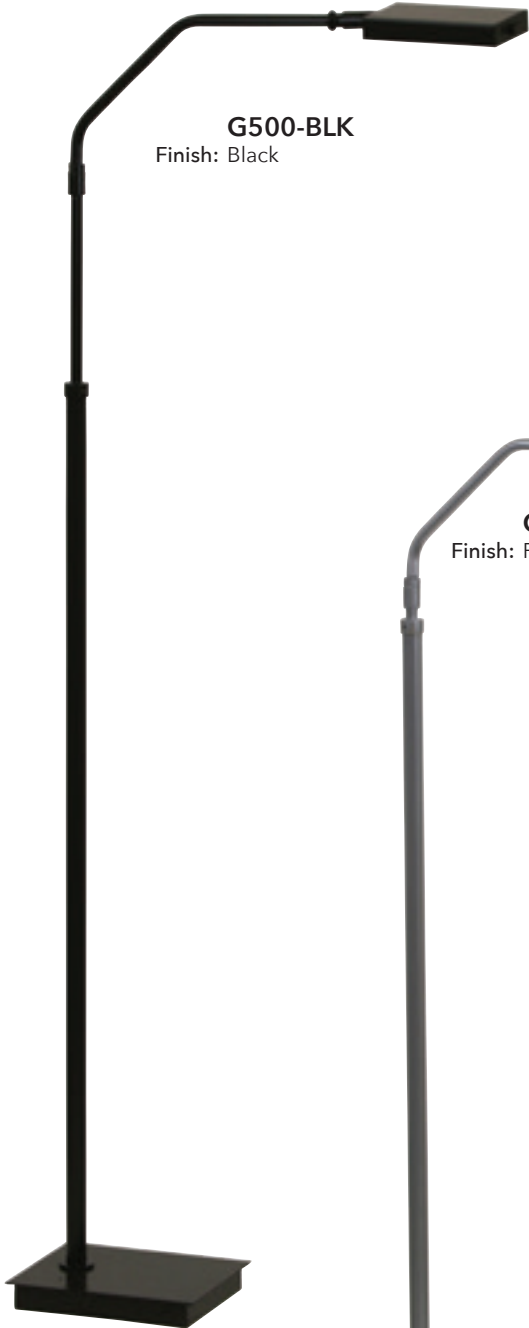

G500-BLK

Finish: Black



G500-WT

Finish: White

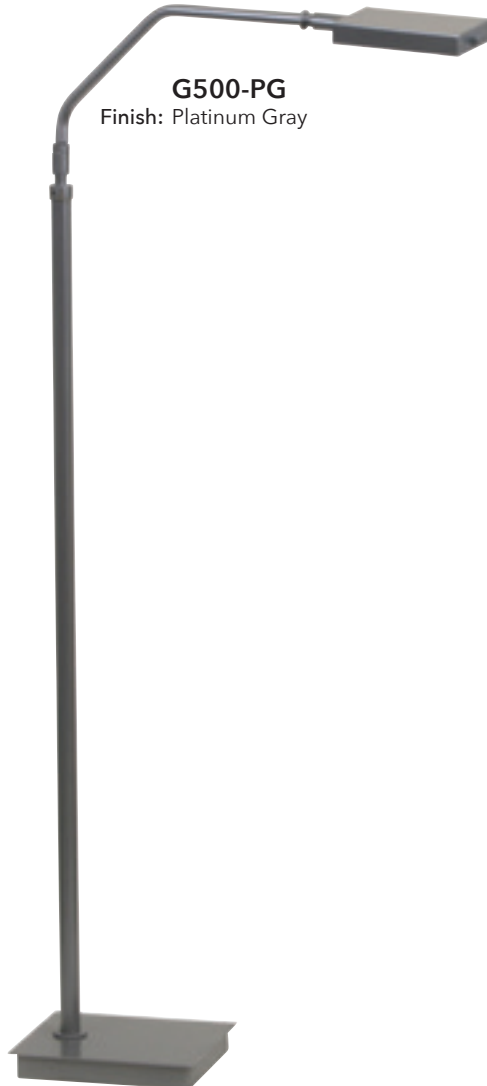

G500-PG

Finish: Platinum Gray

FLOOR/DESK LAMPS

Height: 17½"
Base: 6" × 7¼"
Extension: 11½"
LED: Integrated 2900K, 96 CRI, 6.8 Watts, 800 Lumens
Switch: On Shade
Shade: 2½" × 5"
Cord: 10' Clear with Plug-in Driver



G550-ABZ
Finish: Architectural Bronze



G550-WT
Finish: White



G550-BLK
Finish: Black



G550-PG
Finish: Platinum Gray

Generation 5

Plug-in Only

Height: 5"
Backplate: 5" x 5"
Extension: 22¼"
LED: Integrated 2900K, 96 CRI, 6.8 Watts, 800 Lumens Included
Switch: On Shade
Shade: 2½" x 5"
Cord: 10' Clear with Plug-in Driver
30" Cord Cover

G575-BLK
Finish: Black



G575-PG
Finish: Platinum Gray



G575-ABZ
Finish: Architectural Bronze



G575-WT
Finish: White



Geo Mini



Our Geo Mini lamps are the perfect accent lamp for a hallway, bedroom or entry.

Small in stature, powder coated in four finishes, and easily switched on the cord.

Geo Mini

Finish: White with Weathered Brass Accents

Bulb: 60W B10

Switch: In-Line

Shade: White Linen Hardback

4" x 6" x 6"

Cord: 10' Clear



GEO206

Height: 12"
Base: 5"



GEO306

Height: 12"
Base: 4½"



GEO106

Height: 12"
Base: 4½"



GEO406

Height: 13"
Base: 5"

ACCENT LAMPS

Finish: Navy Blue with Weathered Brass Accents
Bulb: 60W B10
Switch: In-Line
Shade: White Linen Hardback
4" x 6" x 6"
Cord: 10' Clear



GEO209
Height: 12"
Base: 5"



GEO309
Height: 12"
Base: 4½"



GEO109
Height: 12"
Base: 4½"



GEO409
Height: 13"
Base: 5"

Geo Mini

Finish: Black Matte with Polished Nickel Accents

Bulb: 60W B10

Switch: Black In-Line

Shade: White Linen Hardback

4" x 6" x 6"

Cord: 10' Clear



GEO210

Height: 12"
Base: 5"



GEO310

Height: 12"
Base: 4½"



GEO110

Height: 12"
Base: 4½"



GEO410

Height: 13"
Base: 5"

ACCENT LAMPS

Finish: Mahogany Bronze with Weathered Brass Accents
Bulb: 60W B10
Switch: Black In-Line
Shade: White Linen Hardback
4" x 6" x 6"
Cord: 10' Clear



GEO211
Height: 12"
Base: 5"



GEO311
Height: 12"
Base: 4½"



GEO111
Height: 12"
Base: 4½"



GEO411
Height: 13"
Base: 5"

Hardwick



The combination of leather and richly finished metal make a handsome collection of table and floor lamps. Sturdy, with substantial attachments, these lamps will warm up your den or living room.

FLOOR LAMPS

Height: Adjusts 48" to 60"
Base: 10"
Bulb: 100W 3-way
Switch: On Socket
Shade: 17" x 18" x 12"



H500-AB
Finish: Antique Brass with
Brown Leather
Shade: Off White Linen Hardback
Cord: 10' Brown



H500-SN
Finish: Satin Nickel with
Black Leather
Shade: White Linen Hardback
Cord: 10' Clear

Hardwick

Height: 63"
Base: 11"
Bulbs: One 150W Type A
Three 75W Type A
Switch: On Column
Shade: 17" x 18" x 12"



H503-AB
Finish: Antique Brass
with Brown Leather
Shade: Off White Linen Hardback
Cord: 10' Brown



H503-SN
Finish: Satin Nickel with
Black Leather
Shade: White Linen Hardback
Cord: 10' Clear

FLOOR/TABLE LAMPS

Height: Adjusts 23" to 28"
Base: 7"
Bulb: 100W 3-way
Switch: On Socket
Shade: 13" x 14" x 9½"



H550-SN

Finish: Satin Nickel with Black Leather
Shade: White Linen Hardback
Cord: 10' Clear



H550-AB

Finish: Antique Brass with Brown Leather
Shade: Off White Linen Hardback
Cord: 10' Brown

Hardwick

Height: 31½"
Base: 8"
Bulb: One 150W 3-way
Three 75W Type A
Switch: On Column
Shade: 17" × 18" × 12"



H553-AB

Finish: Antique Brass with Brown Leather
Shade: Off White Linen Hardback
Cord: 10' Brown



H553-SN

Finish: Satin Nickel with Black Leather
Shade: White Linen Hardback
Cord: 10' Clear

Home Office



Our Home Office series is clean lined and functional. Two shade styles in the wall and floor versions allow for multiple look and light style options.

Home Office

Height: Adjusts 34" to 48"
Extension: 21"
Base: 10½" Round
Bulb: One 100W Type A
Switch: On-Off on Socket
Shade: 8⅛" x 3"



PH100-52-J
Finish: Satin Nickel
Cord: 10' Clear



PH100-91-J
Finish: Oil Rubbed Bronze
Cord: 10' Brown

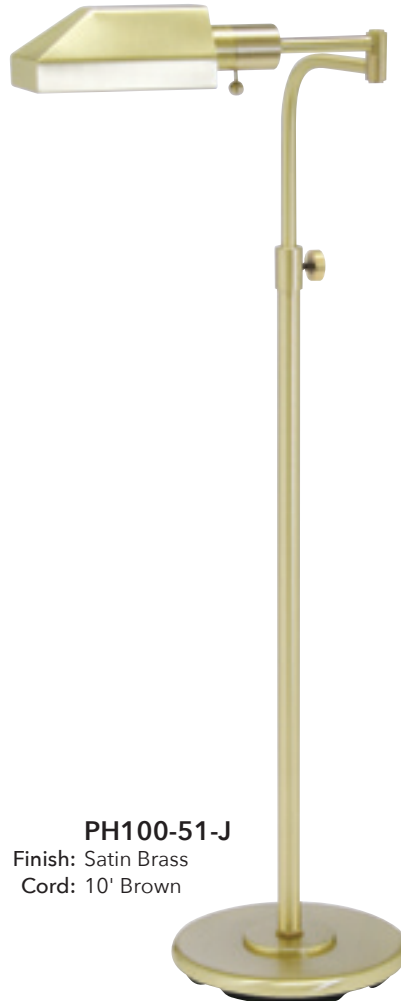

PH100-51-J
Finish: Satin Brass
Cord: 10' Brown

FLOOR LAMPS

Height: Adjusts 34" to 48"
Extension: 21"
Base: 10½" Round
Bulb: One 100W Type A
Switch: On-Off on Socket
Shade: 8½" x 3"
Cord: 10' Brown



PH100-61-J
Finish: Polished Brass

PH100-71-J
Finish: Antique Brass

Home Office

Height: Adjusts 34" to 48"
Extension: 23"
Base: 10½" Round
Bulb: One 60T-10
Switch: On-Off on Socket
Shade: 10" × 2"



PH100-51-F
Finish: Satin Brass
Cord: 10' Brown



PH100-61-F
Finish: Polished Brass
Cord: 10' Brown



PH100-52-F
Finish: Satin Nickel
Cord: 10' Clear

FLOOR LAMPS

Height: Adjusts 34" to 48"
Extension: 23"
Base: 10½" Round
Bulb: One 60T-10
Switch: On-Off on Socket
Shade: 10" x 2"
Cord: 10' Brown



PH100-71-F
Finish: Antique Brass

PH100-91-F
Finish: Oil Rubbed Bronze

Home Office

Height: Adjusts 37" to 51"
Extension: 18"
Base: 10 ½" Round
Bulb: One 100W 3-way
Switch: On Socket
Shade: 4 ½" x 14" x 7"
Attaches with Acrylic Diffuser



PH101-52

Finish: Satin Nickel
Shade: White Linen Hardback
Cord: 10' Clear

FLOOR/WALL LAMPS

Height: 5"
Extension: 24"
Backplate: 5" Round
Bulb: One 100W Type A
Switch: On-Off on Socket
Shade: 8¾" x 3"
Cord: 10' Clear
30" Cord Cover



WS12-51-J
Finish: Satin Brass

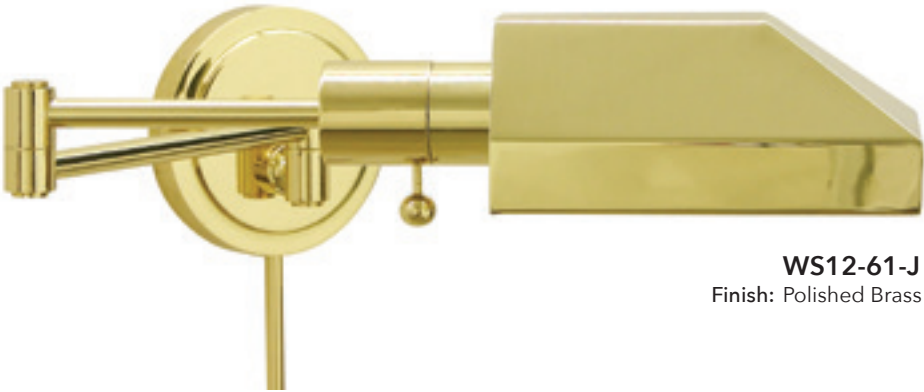

WS12-61-J
Finish: Polished Brass

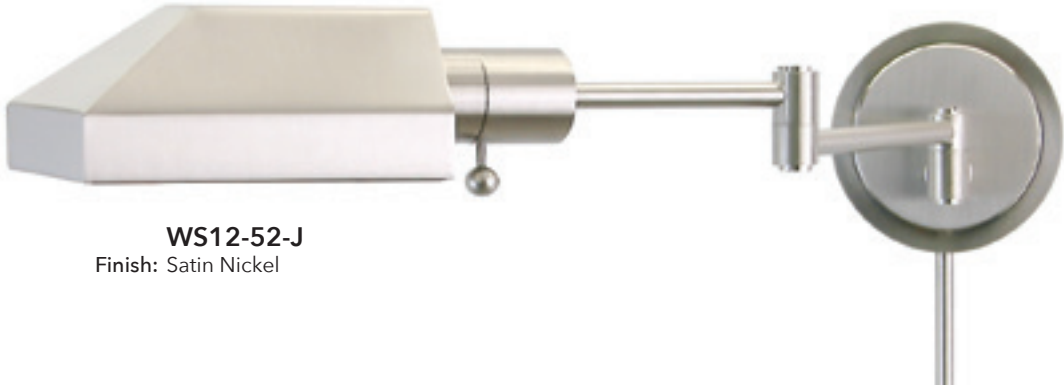

WS12-52-J
Finish: Satin Nickel

Home Office

Height: 5"
Extension: 24"
Backplate: 5" Round
Bulb: One 100W Type A
Switch: On-Off on Socket
Shade: 8¾" x 3"
Cord: 10' Clear
30" Cord Cover

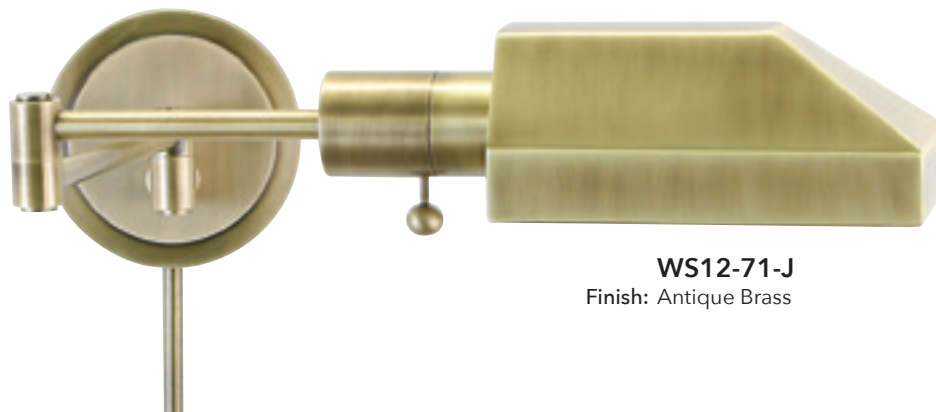

WS12-71-J
Finish: Antique Brass



WS12-91-J
Finish: Oil Rubbed Bronze

WALL LAMPS

Height: 5"
Extension: 26"
Backplate: 5" Round
Bulb: One 60T10
Switch: On-Off on Socket
Shade: 10" x 2"
Cord: 10' Clear
30" Cord Cover

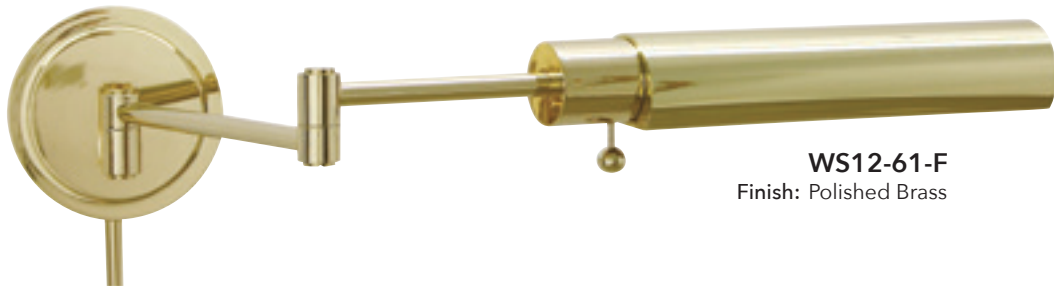

WS12-61-F
Finish: Polished Brass



WS12-52-F
Finish: Satin Nickel

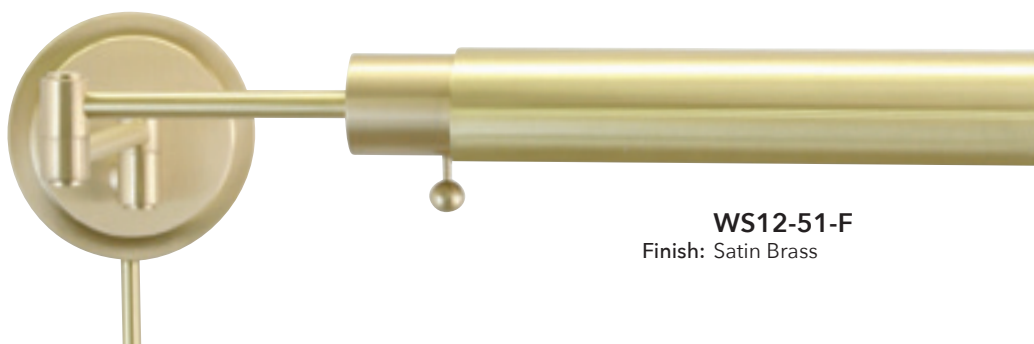

WS12-51-F
Finish: Satin Brass

Home Office

Height: 5"
Extension: 26"
Backplate: 5" Round
Bulb: One 60T10
Switch: On-Off on Socket
Shade: 10" x 2"
Cord: 10' Clear
30" Cord Cover

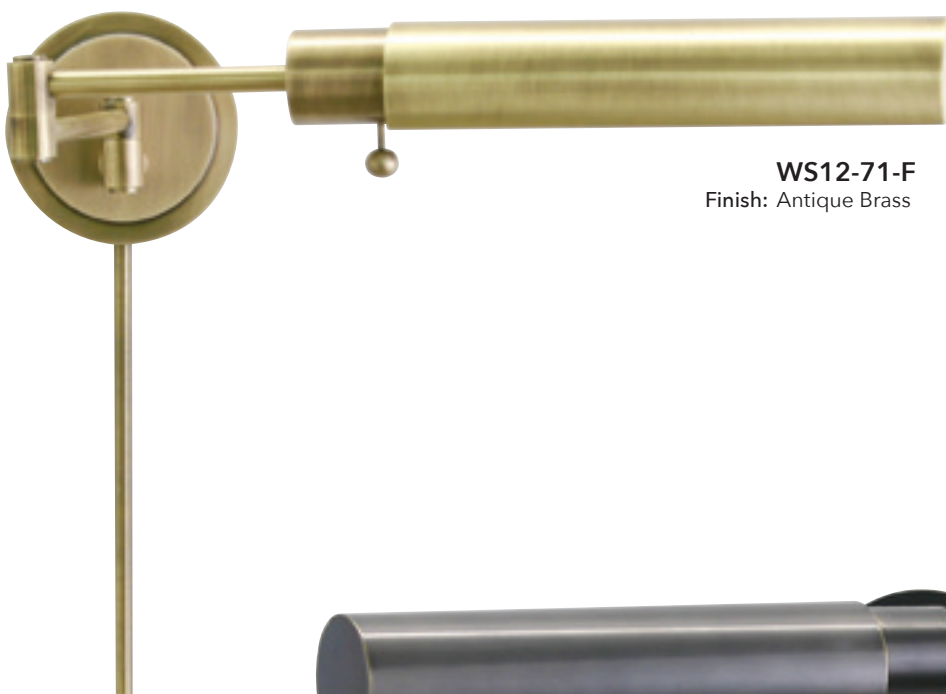

WS12-71-F
Finish: Antique Brass



WS12-91-F
Finish: Oil Rubbed Bronze

WALL LAMPS

Height: 12½"
Extension: 27"
Backplate: 18" × 4½" × ⅝"
Bulb: Two 100W 3-way
Switch: On Socket

Shade: 6½" × 12" × 7"
Attaches with Acrylic Diffuser
Cord: 10' Clear
30" Cord Cover



Home Office

Height: 12"
Extension: 27"
Backplate: 5" Round
Bulb: One 100W 3-way
Switch: On Socket
Shade: 6½" x 12" x 7"
Attaches with Acrylic Diffuser
Cord: 10' Clear
30" Cord Cover

WS14-51
Finish: Satin Brass
Shade: Off-white Linen
Hardback



WS14-52
Finish: Satin Nickel
Shade: White Linen
Hardback



WS14-61
Finish: Polished Brass
Shade: Off-white Linen Hardback

WALL LAMPS

Height: 12"
Extension: 27"
Backplate: 5" Round
Bulb: One 100W 3-way
Switch: On Socket
Shade: 6½" x 12" x 7"
Attaches with Acrylic Diffuser
Cord: 10' Clear
30" Cord Cover



WS14-71
Finish: Antique Brass
Shade: Off-white Linen Hardback



WS14-9
Finish: White
Shade: White Linen Hardback



WS14-91
Finish: Oil Rubbed Bronze
Shade: Off-white Linen Hardback

Home Office

Height: 23½"
Extension: 20½"
Base: 7½" Round
Bulb: One 100W 3-way
Switch: On Socket
Shade: 6½" x 12" x 7"
Attaches with Acrylic Diffuser



D436-71
Finish: Antique Brass
Shade: Off-white Linen Hardback
Cord: 9' Brown



D436-52
Finish: Satin Nickel
Shade: White Linen Hardback
Cord: 9' Clear



Minimal in their design, with 500 lumens of light output, the Horizon Task series is suited to illuminate your work surface.

Table and floor designs are fully adjustable, and powder coated for durability.

Horizon

Height: Adjusts 37½" to 49½"

Extension: 20½"

Base: 10½" × 8½"

LED: Integrated 3000K, 85 CRI, 4.5 Watts, 500 Lumens

Switch: On Shade

Shade: 14"

Cord: 10' Brown



HLEDZ600-PG
Finish: Platinum Gray



HLEDZ600-GT
Finish: Granite



HLEDZ600-ABZ
Finish: Architectural Bronze

FLOOR/DESK LAMPS

Height: Adjusts 12" to 19"
Extension: 29" Maximum
Base: 7¼" x 6"
LED: Integrated 3000K, 85 CRI, 4.5 Watts, 500 Lumens
Switch: On Shade
Shade: 14"
Cord: 10' Brown



HLEDZ650-ABZ
Finish: Architectural Bronze

HLEDZ650-GT
Finish: Granite



HLEDZ650-PG
Finish: Platinum Gray

Hyde Park



Full range dimming on table and wall make for excellent couch or bedside control on this Hyde Park series.

FLOOR LAMPS

Height: 57"
Extension: 19½"
Base: 10" Round
Bulb: One 100W Type A
Switch: Hi-Lo on Column
Cord: 10' Brown



HP700-OB-WL
Finish: Oil Rubbed Bronze
Shade: Off-white Linen Hardback
5" x 9" x 7"



HP700-OB-MSOB
Finish: Oil Rubbed Bronze
Shade: Metal
5" x 7½" x 6¼"



HP700-OB-BP
Finish: Oil Rubbed Bronze
Shade: Black Parchment
5" x 9" x 7"

Hyde Park

Height: 57"
Extension: 19½"
Base: 10" Round
Bulb: One 100W Type A
Switch: Hi-Lo on Column
Cord: 10' Brown



HP700-WB-MSWB

Finish: Weathered Brass
Shade: Metal
5" × 7½" × 6¼"

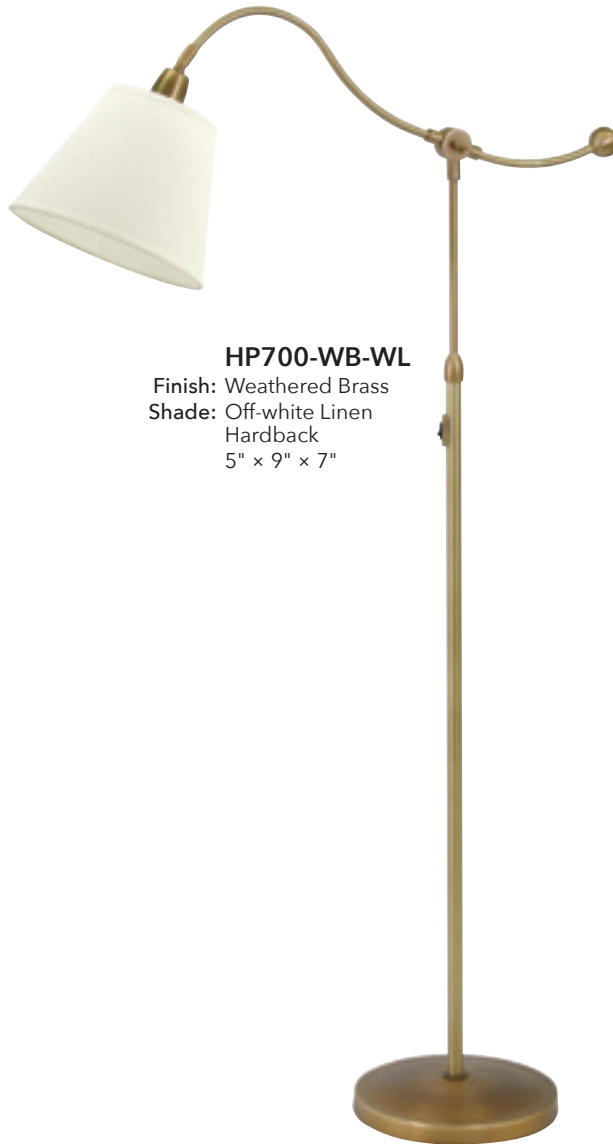

HP700-WB-WL

Finish: Weathered Brass
Shade: Off-white Linen
Hardback
5" × 9" × 7"



HP700-WB-BP

Finish: Weathered Brass
Shade: Black Parchment
5" × 9" × 7"

FLOOR/WALL LAMPS

Height: 12½"
Extension: 20"
Backplate: 5" Round
Switch: Full Range Dimmer on Backplate
Cord: 10' Ivory
30" Cord Cover



HP725-OB-WL

Finish: Oil Rubbed Bronze
Bulb: One 100W Type A
Shade: Off-white Linen Hardback
5" × 9" × 7"



HP725-OB-BP

Finish: Oil Rubbed Bronze
Bulb: One 100W Type A
Shade: Black Parchment
5" × 9" × 7"



HP725-OB-MSOB

Finish: Oil Rubbed Bronze
Bulb: One 100W Type A
Shade: Metal
5" × 7½" × 6¼"

Hyde Park

Height: 12½"
Extension: 20"
Backplate: 5" Round
Switch: Full Range Dimmer on Backplate
Cord: 10' Ivory
30" Cord Cover



HP725-WB-MSWB

Finish: Weathered Bronze
Bulb: One 100W Type A
Shade: Metal 5" × 7½" × 6¼"



HP725-WB-BP

Finish: Weathered Brass
Bulb: One 100W Type A
Shade: Black Parchment
5" × 9" x 7"



HP725-WB-WL

Finish: Weathered Brass
Bulb: One 100W Type A
Shade: Off-white Linen Hardback
5" × 9" × 7"

WALL/TABLE LAMPS

Height: 26"
Extension: 14"
Base: 7" Round
Bulb: One 100W Type A
Switch: Full Range Dimmer on Base
Cord: 10' Brown



HP750-OB-BP
Finish: Oil Rubbed Bronze
Shade: Black Parchment
5" x 9" x 7"



HP750-OB-MSOB
Finish: Oil Rubbed Bronze
Shade: Metal
5" x 7½" x 6¼"



HP750-OB-WL
Finish: Oil Rubbed Bronze
Shade: Off-white Linen Hardback
5" x 9" x 7"

Hyde Park

Height: 26"
Extension: 14"
Base: 7" Round
Bulb: One 100W Type A
Switch: Full Range Dimmer on Base
Cord: 10' Brown



HP750-WB-BP
Finish: Weathered Brass
Shade: Black Parchment
5" x 9" x 7"



HP750-WB-MSWB
Finish: Weathered Brass
Shade: Metal
5" x 7½" x 6¼"



HP750-WB-WL
Finish: Weathered Brass
Shade: Off-white Linen Hardback
5" x 9" x 7"

Height: 58" to 70"
Base: 8" Diameter
Bulb: One 60W Vintage
Switch: Full Range Dimmer on Socket
Shade: Clear Seedy Glass



IR700-AB
Finish: Antique Brass
Cord: 10' Brown



IR700-PN
Finish: Polished Nickel
Cord: 10' Clear



IR700-OB
Finish: Oil Rubbed Bronze
Cord: 10' Brown

Ira

Height: 58" to 66"
Base: 8" Diameter
Bulb: One 60W Vintage
Switch: Full Range Dimmer on Socket



IR701-OB
Finish: Oil Rubbed Bronze
Cord: 10' Brown



IR701-PN
Finish: Polished Nickel
Cord: 10' Clear



IR701-AB
Finish: Antique Brass
Cord: 10' Brown

FLOOR LAMPS

Height: 42" to 68"
Base: 11" Diameter
Bulb: Three 60W Vintage
Switch: Full Range Dimmer on Socket



IR703-OB
Finish: Oil Rubbed Bronze
Cord: 10' Brown



IR703-AB
Finish: Antique Brass
Cord: 10' Brown



IR703-PN
Finish: Polished Nickel
Cord: 10' Clear

Ira

Height: 21"

Base: 7" with USB port

Bulb: One 60W Vintage

Switch: Full Range Dimmer on Socket



IR751-PN

Finish: Polished Nickel
Cord: 10' Clear



IR751-AB

Finish: Antique Brass
Cord: 10' Brown



IR751-OB

Finish: Oil Rubbed Bronze
Cord: 10' Brown

Height: 52"
Extension: 15½"
Base: 8" × 13"
LED: Integrated 3000K, 85 CRI, 4.5 Watts, 500 Lumens
Switch: On Shade
Shade: Metal
3¾" × 14"



JLED500-GT
Finish: Granite with Satin Nickel
Cord: 10' Black

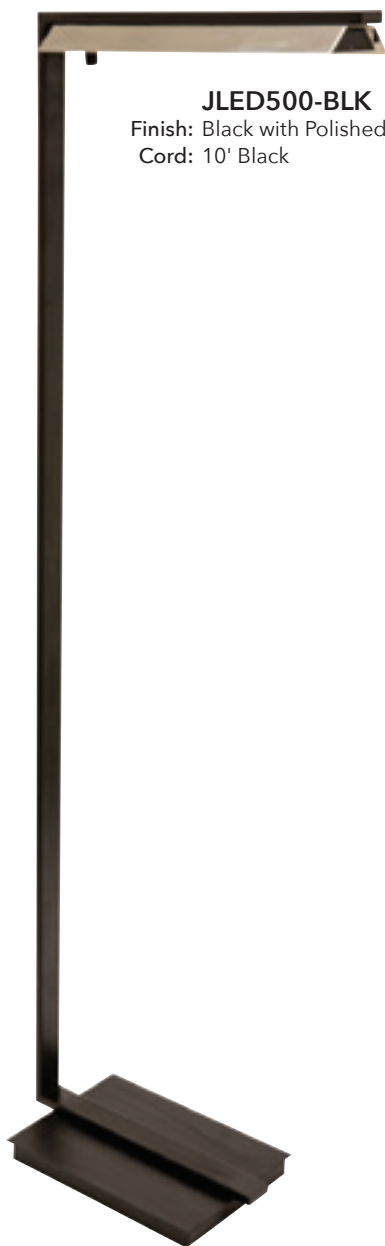

JLED500-BLK
Finish: Black with Polished Nickel
Cord: 10' Black



JLED500-CHB
Finish: Chestnut Bronze with Antique Brass
Cord: 10' Brown

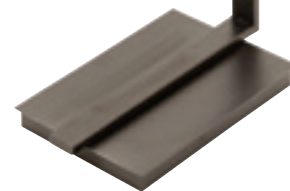

Jay

Height: 19"
Extension: 15½"
Base: 4½" x 12"
LED: Integrated 3000K, 85 CRI, 4.5 Watts, 500 Lumens
Switch: On Shade
Shade: Metal
3¾" x 14"



JLED550-BLK
Finish: Black with Polished Nickel
Cord: 10' Black



JLED550-GT
Finish: Granite with Satin Nickel
Cord: 10' Black



JLED550-CHB
Finish: Chestnut Bronze with Antique Brass
Cord: 10' Brown



Kirby has a vintage look but on the inside it's all modern. Features include an integrated LED array, easy access switching on the shade, and maximum adjustability. The desk lamps come with USB port in base.

Kirby

Height: Adjusts 42" to 54"

Base: 11"

LED: Integrated 3000K, 80 CRI, 6.2 Watts, 600 Lumens

Switch: On Shade

Shade: 2¼" x 4¼" x 5½"

Cord: 10' Silver



K100-GR

Finish: Gray



K100-WT

Finish: White



K100-BLK

Finish: Black

FLOOR LAMPS

Height: 64"
Extension: 5½"
Base: 11"
LED: Integrated 3000K, 80 CRI, 6.2 Watts, 600 Lumens
Switch: On Shade
Shade: 2¼" x 4¼" x 5½"
Cord: 10' Silver

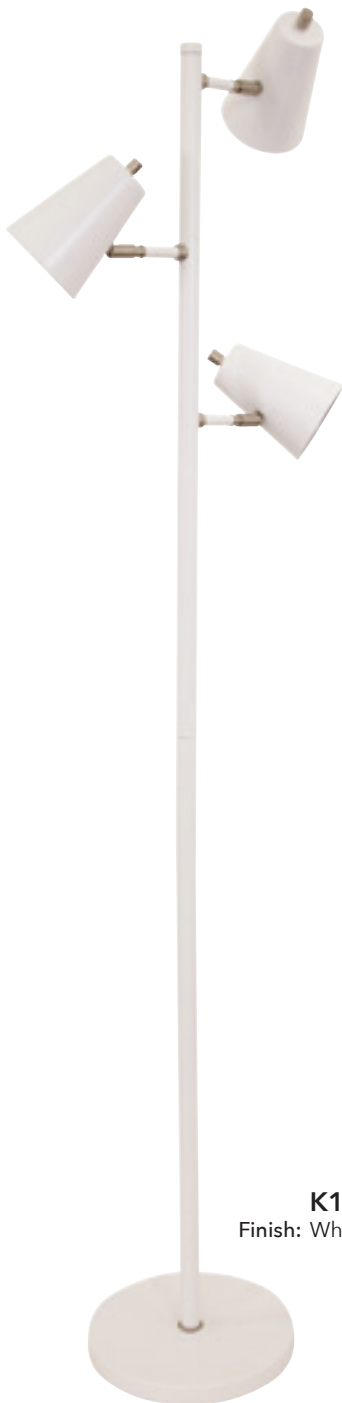

K130-WT
Finish: White



K130-GR
Finish: Gray



K130-BL
Finish: Black

Kirby

Height: 23½"

Base: 7" with USB Port

Extension: 13"

LED: Integrated 3000K, 80 CRI, 6.2 Watts, 600 Lumens

Switch: On Shade

Shade: 2¼" × 4¼" × 5½"

Cord: 10' Silver



K150-BLK
Finish: Black



K150-TL
Finish: Teal



K150-GR
Finish: Gray

DESK LAMPS

Height: 23½"

Base: 7" with USB Port

Extension: 13"

LED: Integrated 3000K, 80 CRI, 6.2 Watts, 600 Lumens

Switch: On Shade

Shade: 2¼" × 4¼" × 5½"

Cord: 10' Silver



K150-PK
Finish: Pink



K150-WT
Finish: White

Kirby

Height: 6¼"
Backplate: 5"
Extension: 9½"
LED: Integrated 3000K, 80 CRI, 6.2 Watts, 600 Lumens
Switch: On Shade
Shade: 2¼" × 4¼" × 5½"
Cord: 10' Silver
Cord Cover: 30"



K175-GR
Finish: Gray



K175-BLK
Finish: Black



K175-WT
Finish: White



A clean and transitional look for a classic six way lamp offered in either floor or table versions.

Lancaster

Height: 62¾"

Base: 11" Round

Bulb: One 150W 3-way,
Three 75W Type A

Switch: On Column

Shade: 15" x 17" x 10½"



L800-SN

Finish: Satin Nickel
Shade: White Linen
Hardback Drum
Cord: 10' Clear



L800-AB

Finish: Antique Brass
Shade: Off-white Linen
Hardback Drum
Cord: 10' Brown



L800-OB

Finish: Oil Rubbed Bronze
Shade: Off-white Linen
Hardback Drum
Cord: 10' Brown

FLOOR/TABLE LAMPS

Height: 31¾"
Base: 8" Round
Bulb: One 150W 3-way,
Three 75W Type A
Switch: On Column
Shade: 14" x 16" x 10½"



L850-SN
Finish: Satin Nickel
Shade: White Linen
Hardback Drum
Cord: 10' Clear



L850-OB
Finish: Oil Rubbed
Bronze
Shade: Off-white Linen
Hardback Drum
Cord: 10' Brown



L850-AB
Finish: Antique Brass
Shade: Off-white Linen
Hardback Drum
Cord: 10' Brown

Lewis

Height: 52"
Extension: 19"
Base: 8½" x 10½"
LED: Integrated 2900K, 96 CRI, 6.8 Watts, 800 Lumens
Switch: On Shade
Shade: Metal
2½" x 5½"
Cord: 10' Clear with Plug-in Driver

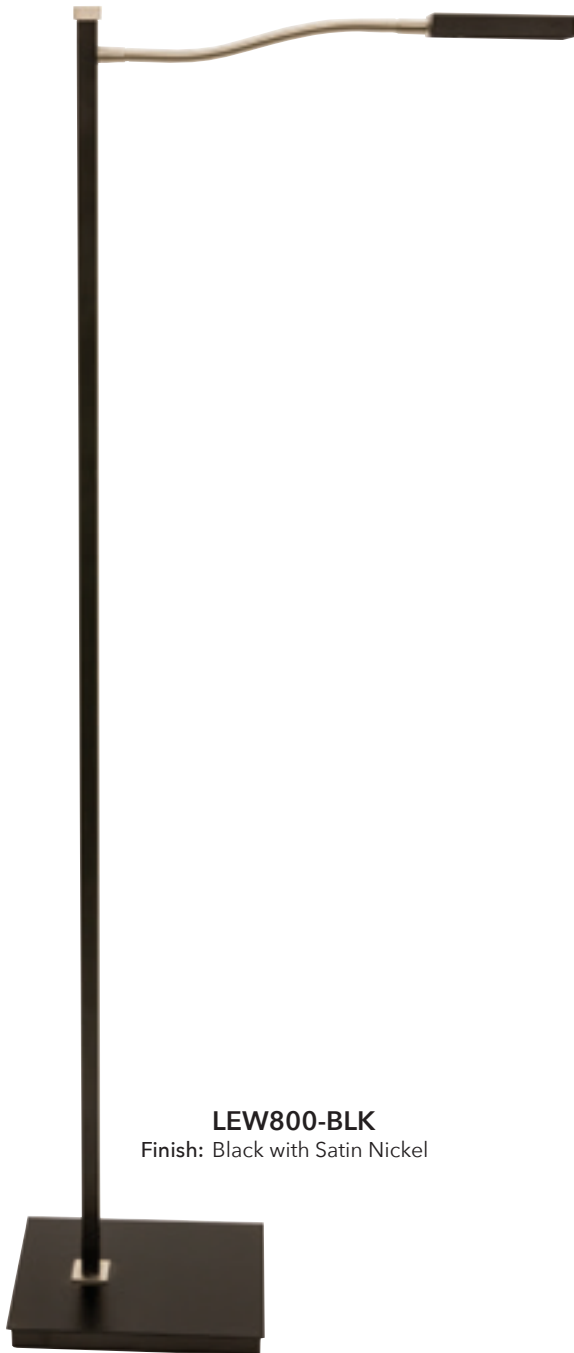

LEW800-BLK
Finish: Black with Satin Nickel



LEW800-GT
Finish: Granite with Satin Nickel

FLOOR/TABLE/WALL LAMPS

LED: Integrated 2900K, 96 CRI, 6.8 Watts, 800 Lumens
Extension: 19"
Switch: On Shade
Shade: Metal
2½" x 5½"
Cord: 10' Clear with Plug-in Driver



LEW850-GT
Finish: Granite with Satin Nickel
Height: 17½"
Base: 6" x 7¼"



LEW850-BLK
Finish: Black with Satin Nickel
Height: 17½"
Base: 6" x 7¼"



LEW875-BLK
Finish: Black with Satin Nickel
Height: 5"
Base: 5" x 5"



LEW875-GT
Finish: Granite with Satin Nickel
Height: 5"
Base: 5" x 5"

Morgan

Height: 62"
Base: 11¾" Diameter
Bulb: One 150W 3-way
Switch: On Socket
Shade: 15" x 18" x 12"



M600-BLKPN

Finish: Black with Polished Nickel
Shade: White Linen Hardback
Cord: 10" Clear

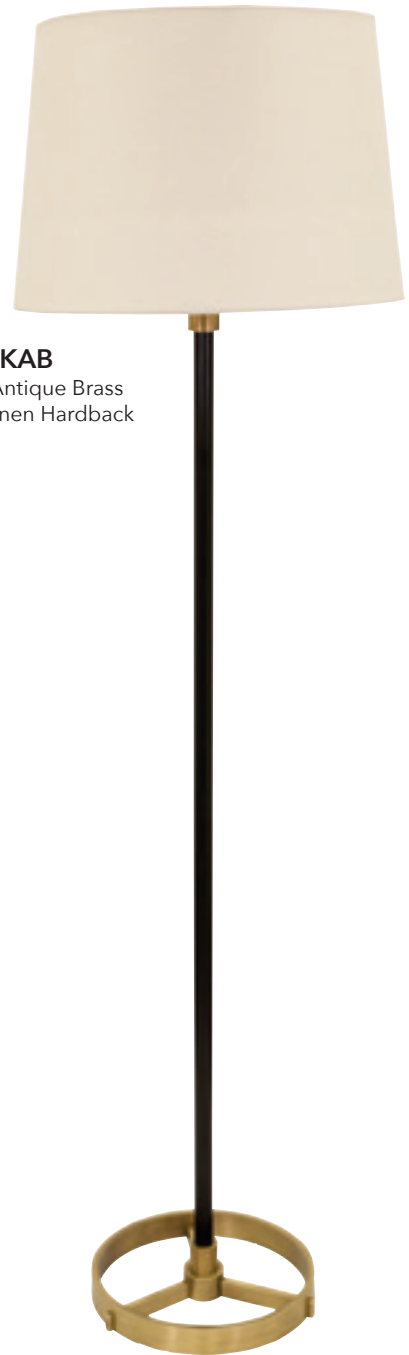

M600-BLKAB

Finish: Black with Antique Brass
Shade: Off-white Linen Hardback
Cord: 10" Brown

FLOOR LAMPS

Height: 54" to 65"
Extension: 19"
Base: 11¾" Diameter
Bulb: One 75W Type A
Switch: On Socket
Shade: Metal
5" x 9" x 7"

NOTE: Cord exits from
adjustment arm



M601-BLKPN
Finish: Black with Polished Nickel
Cord: 10" Clear



M601-BLKAB
Finish: Black with Antique Brass
Cord: 10" Brown

Morgan

Height: 32"
Base: 9" Diameter
Bulb: One 150W 3-way
Switch: On Socket
Shade: 12" x 14" x 10"



M650-BLKAB

Finish: Black with Antique Brass
Shade: Off-white Linen Hardback
Cord: 10" Brown



M650-BLKPN

Finish: Black with Polished Nickel
Shade: White Linen Hardback
Cord: 10" Clear

TABLE LAMPS

Height: 30"
Extension: 19"
Base: 9" Diameter
Bulb: One 75W Type A
Switch: On Socket
Shade: Metal
5" x 9" x 7"

NOTE: Cord exits from
adjustment arm



M651-BLKPN

Finish: Black with Polished Nickel
Cord: 10" Clear



M651-BLKAB

Finish: Black with Antique Brass
Cord: 10" Brown

Morgan

Height: 27"
Backplate: 4½" x 6"
Bulb: One 75W Type A
Switch: On Socket
Shade: Metal
5" x 9" x 7"
Cord: 10" Clear
30" Cord Cover

NOTE: Cord exits from
adjustment arm



M675-BLKPN
Finish: Black with Polished Nickel



M675-BLKAB
Finish: Black with Antique Brass

Newbury

Height: 42" to 54"
Base: 7" x 7"
LED: 3000K, 90+ CRI, 5 Watts, 545 Lumens Candelabra Base
Switch: On Shade
Shade: Metal
2" x 3" x 7"



NEW200-AB

Finish: Antique Brass
Cord: 10' Brown



NEW200-SN

Finish: Satin Nickel
Cord: 10' Clear



NEW200-BLK

Finish: Black
Cord: 10' Black

Newbury

Height: 21"

Base: 7" x 7" with USB Port

LED: 3000K, 90+ CRI, 5 Watts, 545 Lumens Candelabra Base

Switch: On Shade

Shade: Metal

2" x 3" x 7"



NEW250-AB

Finish: Antique Brass

Cord: 10' Brown



NEW250-BLK

Finish: Black

Cord: 10' Black



NEW250-SN

Finish: Satin Nickel

Cord: 10' Clear

DESK/WALL LAMPS

Height: 5"
Base: 5" x 5" with USB Port
LED: 3000K, 90+ CRI, 5 Watts, 545 Lumens Candelabra Base
Switch: On Shade
Shade: Metal
2" x 3" x 7"



NEW275-AB
Finish: Antique Brass
Cord: 10' Brown



NEW275-BLK
Finish: Black
Cord: 10' Black



NEW275-SN
Finish: Satin Nickel
Cord: 10' Clear

Newport



Our most popular series, Newport offers great value for a classic style and functional light. Six way floor and table lamps provide maximum light output.

FLOOR LAMPS

Base: 12" Round
Bulb: One 150W Type A
Switch: Floor Dimmer
Cord: 10' Brown



N600-AB-O
 Height: 69"
 Finish: Antique Brass
 Shade: Opal Glass
 15¾" x 6"



N600-OB-O
 Height: 69"
 Finish: Oil Rubbed
 Bronze
 Shade: Opal Glass
 15¾ x 6"



N600-AB
 Height: 74¾"
 Finish: Antique Brass
 Shade: Amber Glass
 9" x 11¾"



N600-OB
 Height: 74¾"
 Finish: Oil Rubbed Bronze
 Shade: Amber Glass
 9½" x 11¾"

Newport

Height: 57½"
Base: 12" Round
Bulbs: Two 100W Type A
Switch: Pull Chain
Shade: 12" x 19" x 12"



N601-OB
Finish: Oil Rubbed Bronze
Shade: Off-white Softback
Cord: 10' Brown



N601-PTR
Finish: Pewter
Shade: White Softback
Cord: 10' Clear

N601-AB
Finish: Antique Brass
Shade: Off-white Softback
Cord: 10' Brown



FLOOR LAMPS

Height: 55¾"
Base: 12" Round
Bulb: One 150W 3-way
Switch: On Socket
Shade: 12" x 19" x 12"
Table: 17" Diameter
Table Height 24"

N602-AB

Finish: Antique Brass
Shade: Off-white Softback
Cord: 10' Brown



N602-OB

Finish: Oil Rubbed Bronze
Shade: Off-white Softback
Cord: 10' Brown



Newport

Height: 66½"
Base: 12" Round
Bulbs: Standard Six-way
One 150W 3-way,
Three 75W Single
Switch: Top of Column
Shade: 12" x 19" x 12"



N603-PTR

Finish: Pewter
Shade: White Softback
Cord: 10' Clear

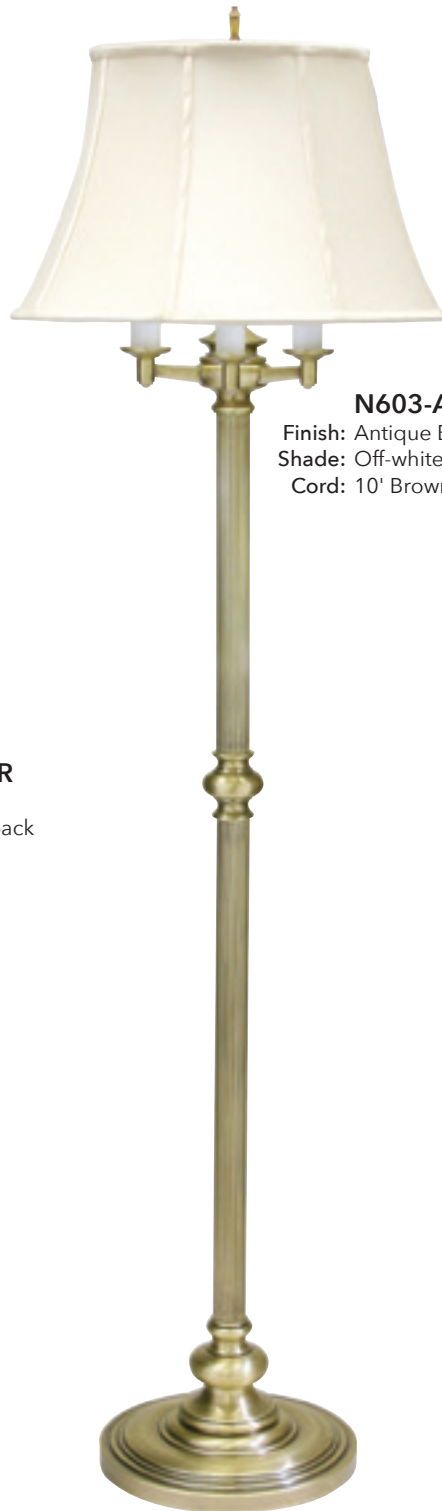

N603-AB

Finish: Antique Brass
Shade: Off-white Softback
Cord: 10' Brown

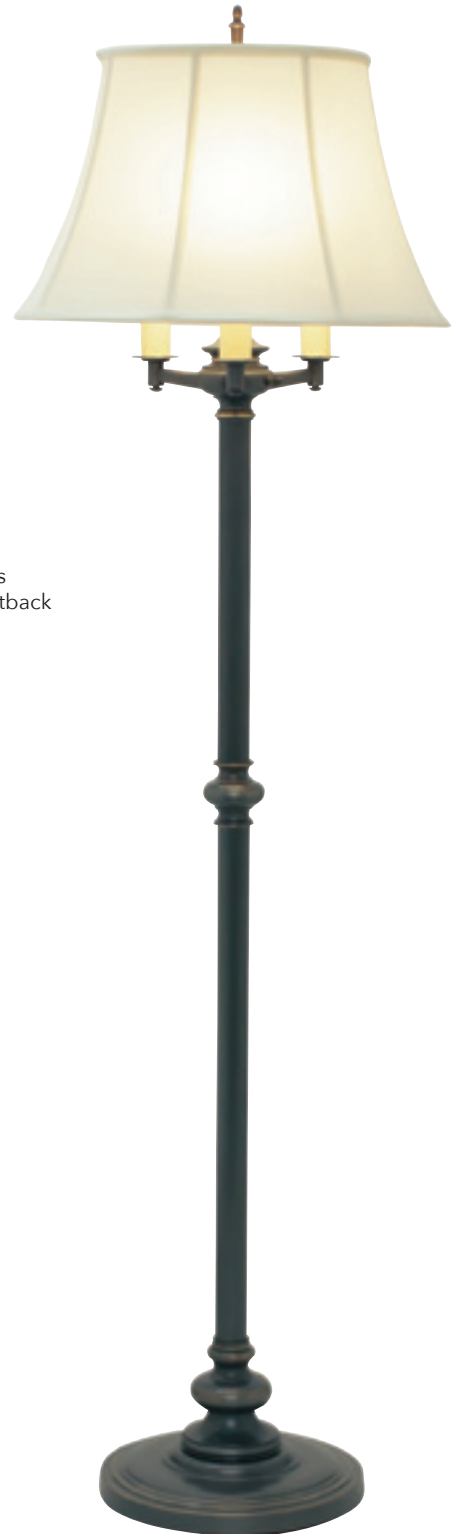

N603-OB

Finish: Oil Rubbed Bronze
Shade: Off-white Softback
Cord: 10' Brown

FLOOR LAMPS

Height: 61"
Extension: 23"
Base: 12" Round
Bulb: One 150W 3-way
Switch: On Socket
Shade: 10" x 18" x 10 1/2"

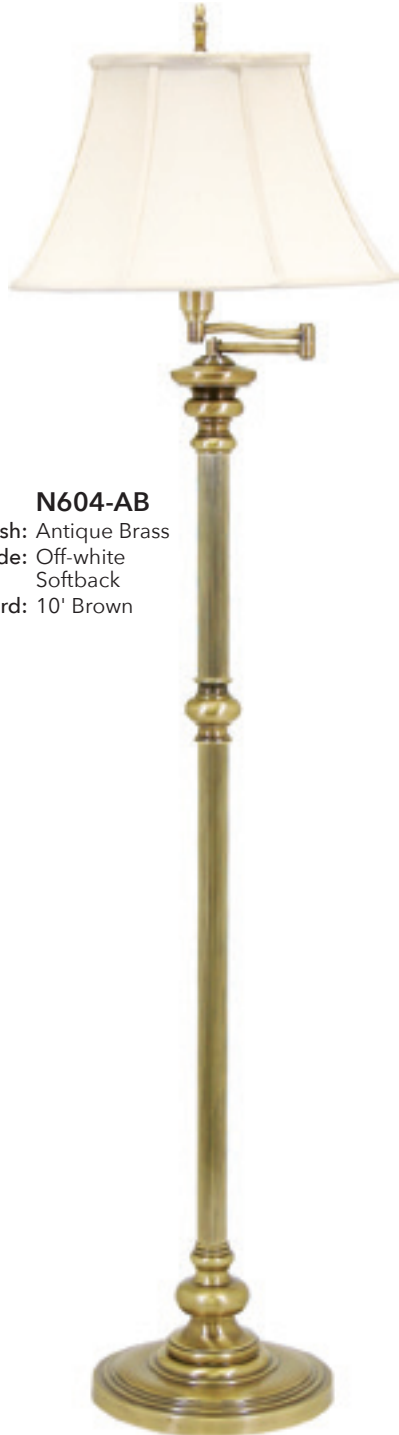

N604-AB
Finish: Antique Brass
Shade: Off-white
Softback
Cord: 10' Brown



N604-OB
Finish: Oil Rubbed Bronze
Shade: Off-white Softback
Cord: 10' Brown



N604-PTR
Finish: Pewter
Shade: White Softback
Cord: 10' Clear

Newport

Height: 63"
Base: 12" Round
Bulb: Standard Six-way
One 150W 3-way
Three 75W Single
Switch: Top of Column
Shade: 13" x 19" x 11½"

N606-AB

Finish: Antique Brass
Shade: Off-white Softback
Cord: 10' Brown



N606-OB

Finish: Oil Rubbed Bronze
Shade: Off-white Softback
Cord: 10' Brown



FLOOR/TABLE LAMPS



N652-OB
Finish: Oil Rubbed Bronze
Height: 30 3/4"
Base: 6" Round
Bulbs: One 100W 3-way
Switch: On Socket
Shade: Off-white Softback
7" x 15 3/4" x 11"
Cord: 10' Brown



N650-AB
Finish: Antique Brass
Height: 30 1/4"
Base: 9" Round
Bulbs: Standard Six Way
One 150W 3-way
Three 75W Type A
Switch: On Column
Shade: Off-white Softback
12" x 19" x 12"
Cord: 10' Brown



N650-OB
Finish: Oil Rubbed Bronze
Height: 30 1/4"
Base: 9" Round
Bulbs: Standard Six Way
One 150W 3-way
Three 75W Type A
Switch: On Column
Shade: Off-white Softback
12" x 19" x 12"
Cord: 10' Brown

Newport

Height: 30¼"
Base: 7¾" Round
Bulbs: Two 60W Type A
Switch: Pull Chain
Shade: 10" x 18" x 10¼"

N651-AB

Finish: Antique Brass
Shade: Off-white Softback
Cord: 10' Brown



N651-PTR

Finish: Pewter
Shade: White Softback
Cord: 10' Clear



N651-OB

Finish: Oil Rubbed Bronze
Shade: Off-white Softback
Cord: 10' Brown



Reminiscent of the industrial work lights of a bygone era, the Otis series is an adjustable task lamp with mix and match metal and cased glass shades.

Otis

Height: Adjusts 49" to 67"
Extension: 23"
Base: 10"
Bulb: 60W Type A
Switch: On Socket
Shade: 2¼" x 10" x 4¾"
(Metal Shown MS)

Glass Shade Options



Amber (AM)



Green (GR)



White (WT)



OT600-SN-MS

Finish: Satin Nickel
Cord: 10' Clear

OT600-AB-MS

Finish: Antique Brass
Cord: 10' Brown

OT600-OB-MS

Finish: Oil Rubbed Bronze
Cord: 10' Brown

FLOOR/TABLE LAMPS

Height: 26"
Base: 8½"
Bulb: 60W Type A
Switch: On Socket
Shade: 2¼" x 10" x 4¾"
(Metal Shown MS)

Glass Shade Options



Amber (AM)



Green (GR)



White (WT)



OT650-AB-MS

Finish: Antique Brass
Cord: 10' Brown



OT650-OB-MS

Finish: Oil Rubbed Bronze
Cord: 10' Brown



OT650-SN-MS

Finish: Satin Nickel
Cord: 10' Clear

Otis

Height: 5"
Extension: 16½"
Base: 5"
Bulb: 60W Type A
Switch: On Socket
Shade: 2¼" x 10" x 4¾"
(Metal Shown MS)

Direct Wire Only

Glass Shade Options



Amber (AM)



Green (GR)



White (WT)



OT675-OB-MS
Finish: Oil Rubbed Bronze



OT675-AB-MS
Finish: Antique Brass



OT675-SN-MS
Finish: Satin Nickel

Pinnacle



Pinnacle is our halogen task series, offering full range dimming and height adjustment.

Pinnacle

Height: Adjusts from 35½" to 50"
Extension: 21½"
Base: 10" Diameter
Bulb: One 50W GU10
Halogen (Included)
Switch: Full Range Dimmer
on Shade
Shade: 6½" x 2¼"



PIN400-SN
Finish: Satin Nickel
Cord: 10' Clear



PIN400-AB
Finish: Antique Brass
Cord: 10' Clear



PIN400-OB
Finish: Oil Rubbed Bronze
Cord: 10' Brown



FLOOR/TABLE LAMPS

Height: 16"
Extension: 19½"
Base: 7" Diameter
Bulb: One 50W GU10 Halogen (Included)
Switch: Full Range Dimmer on Shade
Shade: 6½" x 2¼"



PIN450-OB
Finish: Oil Rubbed Bronze
Cord: 10' Brown



PIN450-AB
Finish: Antique Brass
Cord: 10' Brown



PIN450-SN
Finish: Satin Nickel
Cord: 10' Clear

Pinnacle

Height: 5½"
Extension: 23¾"
Backplate: 5" Square
Bulb: One 50W GU10 Halogen (Included)
Switch: Full Range Dimmer on Shade
Shade: 6½" × 2¼"
Cord: 10' Ivory
30" Cord Cover

PIN475-AB
Finish: Antique Brass



PIN475-OB
Finish: Oil Rubbed Bronze



PIN475-SN
Finish: Satin Nickel



Richmond



The Richmond series combines a hardwood upright, hefty metal attachments and a simple burlap drum shade giving this lamp an industrial look and feel.

Richmond

Height: Adjusts 51½" to 62"
Extension: 19½"
Base: 11" Round
Bulb: 150W 3-way
Switch: On Socket
Shade: White Burlap Hardback
11" x 15" x 10"
Cord: 10' Brown



R401-AB
Finish: Antique Brass and Walnut
Finished Hardwood



R401-OB
Finish: Oil Rubbed Bronze
with Walnut Finished
Hardwood

FLOOR/TABLE LAMPS

Height: Adjusts 27½" to 31"
Base: 8" Round
Bulb: 150W 3-way
Switch: On Socket
Shade: White Burlap Hardback
11" x 15" x 10"
Cord: 10' Brown



R450-OB

Finish: Oil Rubbed Bronze with Walnut Finished Hardwood



R450-AB

Finish: Antique Brass and Walnut Finished Hardwood

Rupert



A simple powder coated series with metal accents, the Rupert collection will fit your transitional décor. Floor lamps have dimming controls on the upright and table lamps come with USB ports.

FLOOR LAMPS

Height: 62"
Base: 11"
Bulbs: Three 100W Type A
Switch: Full Range Dimmer on Column
Shade: 15" x 17" x 10½"



RU703-GT
Finish: Granite with Satin Nickel Accents
Cord: 10' Black
Shade: White Linen Hardback



RU703-CHB
Finish: Chestnut Bronze with Weathered Brass Accents
Cord: 10' Brown
Shade: Off White Linen Hardback

Rupert

Height: 62"

Base: 11"

Bulbs: Three 100W Type A

Switch: Full Range Dimmer on Column

Shade: 15" x 17" x 10½"



RU703-WT

Finish: White with Weathered Brass Accents

Cord: 10' Clear

Shade: White Linen Hardback



RU703-BLK

Finish: Black with
Satin Nickel Accents

Cord: 10' Black

Shade: White Linen Hardback

FLOOR/TABLE LAMPS

Height: 30½"
Base: 8" with USB Port
Bulbs: Three 75W Type A
Switch: Full Range Dimmer on Column
Shade: 14" × 16" × 10½"



RU750-BLK
Finish: Black with Satin Nickel Accents
Cord: 10' Black
Shade: White Linen Hardback



RU750-CHB
Finish: Chestnut Bronze
with Weathered Brass Accents
Cord: 10' Brown
Shade: Off White Linen Hardback

Rupert

Height: 30½"

Base: 8" with USB Port

Bulbs: Three 75W Type A

Switch: Full Range Dimmer on Column

Shade: 14" × 16" × 10½"



RU750-GT

Finish: Granite with Satin Nickel Accents

Cord: 10' Black

Shade: White Linen Hardback



RU750-WT

Finish: White with Weathered Brass Accents

Cord: 10' Clear

Shade: White Linen Hardback

TABLE LAMPS

Height: 21"
Base: 7" with USB Port
Bulb: 100W 3-way
Switch: On Socket
Shade: 9" x 9" x 10"
Cord: 10" Clear



RU751-WT
Finish: White with Weathered
Brass Accents
Cord: 10' Clear
Shade: White Linen Hardback



RU751-GT
Finish: Granite with
Satin Nickel Accents
Cord: 10' Black
Shade: White Linen Hardback

Rupert

Height: 19½"
Base: 7" with USB Port
Bulb: 100W 3-way
Switch: On Socket
Shade: 9" x 9" x 10"
Cord: 10" Clear



RU752-BLK
Finish: Black with
Satin Nickel Accents
Cord: 10' Black
Shade: White Linen Hardback



RU752-CHB
Finish: Chestnut Bronze with
Weathered Brass Accents
Cord: 10' Brown
Shade: White Linen Hardback

Somerset



*Solid square attachments
and shades set Somerset
apart. Glass accents give
this transitional family a bit
of glamour and gloss.*

Somerset

Height: 60"
Base: 10" x 10"
Bulbs: One 150W 3-way
Switch: On Socket
Shade: 13" x 14" x 10"



S900-AB

Finish: Antique Brass
Cord: 10' Brown
Shade: Off-white Linen Hardback

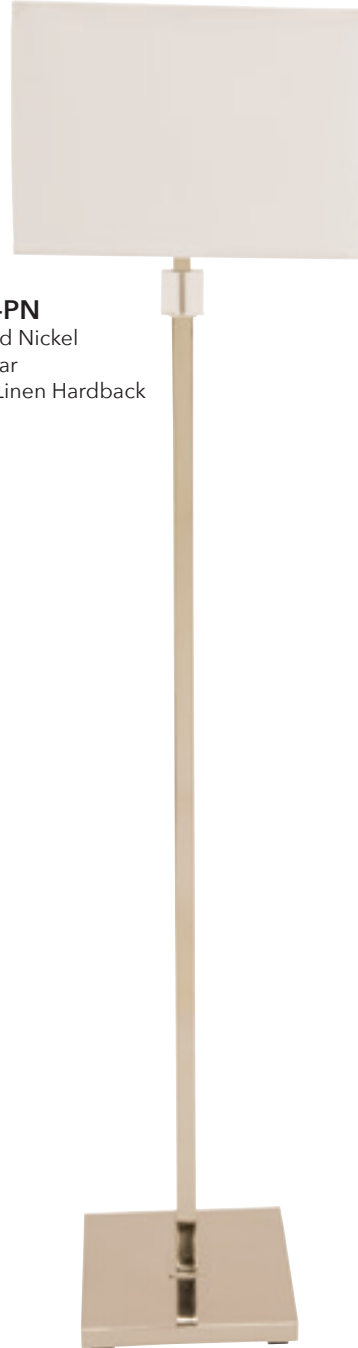

S900-PN

Finish: Polished Nickel
Cord: 10' Clear
Shade: White Linen Hardback

FLOOR LAMPS

Height: 56½"
Extension: 21"
Base: 10" x 10"
Bulbs: One 150W 3-way
Switch: On Socket Cup
Shade: 11" x 12" x 9"



S901-PN
Finish: Polished Nickel
Cord: 10' Clear
Shade: White Linen Hardback



S901-AB
Finish: Antique Brass
Cord: 10' Brown
Shade: Off-white Linen Hardback

Somerset

Height: 28"
Base: 8" x 8"
Bulbs: One 150W 3-way
Switch: On Socket Cup
Shade: 11" x 12" x 9"



S950-PN
Finish: Polished Nickel
Cord: 10' Clear
Shade: White Linen Hardback



S950-AB
Finish: Antique Brass
Cord: 10' Brown
Shade: Off-white Linen Hardback

Town House



Clean and contemporary yet functional. Town House is adjustable in height with a swing arm available in floor and wall. Table lamp is offered with or without convenience outlet on base.

Town House

Height: Adjusts 50" to 58"
Extension: Extends 20"
Base: 10" Round
Bulb: One 100W 3-way
Switch: On Socket
Shade: Off-white Linen Hardback
10" x 13" x 11"

TH700-RB

Finish: Raw Brass
Cord: 10' Brown



TH700-OB

Finish: Oil Rubbed Bronze
Cord: 10" Brown



TH700-PN

Finish: Polished Nickel
Cord: 10' Clear



FLOOR LAMPS

Height: Adjusts 46" to 58"
Base: 10" Round
Bulb: One 100W 3-way
Switch: On Socket
Shade: Off-white Linen Hardback
10" x 13" x 11"



TH701-PN
Finish: Polished Nickel
Cord: 10' Clear



TH701-RB
Finish: Raw Brass
Cord: 10' Brown



TH701-OB
Finish: Oil Rubbed Bronze
Cord: 10' Brown

Town House

Height: 15"
Extension: Extends 26"
Backplate: 5" Round
Bulb: One 100W 3-way
Switch: On Socket
Shade: Off-white Linen Hardback
10" x 12" x 9"
Cord: 10' Clear
30" Cord Cover

TH725-OB
Finish: Oil Rubbed Bronze



TH725-PN
Finish: Polished Nickel



TH725-RB
Finish: Raw Brass



WALL/TABLE LAMPS

Height: Adjusts 23" to 28"
Base: 7" Round
Bulb: One 100W 3-way
Switch: On Socket
Shade: Off-white Linen Hardback
10" x 12" x 9"



TH750-RB
Finish: Raw Brass
Cord: 10' Brown



TH750-PN
Finish: Polished Nickel
Cord: 10' Clear



TH750-OB
Finish: Oil Rubbed Bronze
Cord: 10' Brown

Town House

Height: Adjusts 23" to 28"
Base: 7" Round with 120V Convenience Outlet
Bulb: One 100W 3-way
Switch: On Socket
Shade: Off-white Linen Hardback
10" x 12" x 9"
Cord: 10' Brown



TH751-RB
Finish: Raw Brass



TH751-PN
Finish: Polished Nickel



TH751-OB
Finish: Oil Rubbed Bronze

Tripod



*Our Tripod lamps are
height adjustable
and 3-way switched.*

Tripod

Height: Adjusts 46" to 60"

Base: 24" Diameter

Bulb: 150W 3-way

Switch: On Socket

Shade: 16" x 18 x 11"

TR201-AB

Finish: Antique Brass

Shade: Off-white Linen Hardback

Cord: 10' Brown

TR201-SN

Finish: Satin Nickel

Shade: White Linen Hardback

Cord: 10' Silver



TR202-SN

Finish: Satin Nickel

Shade: White Linen Hardback

Cord: 10' Silver

Height: Table Height 24"



Vergennes



Vergennes is a classic floor and table lamp set with pleated fabric shades. Perfect for a traditional room setting.

Vergennes



VG400-AB

Finish: Antique Brass
Height: 59"
Extension: 18½"
Base: 10"
Bulb: One 100W 3-way
Switch: On Socket
Shade: Off-white
Monaco Pleat Soft Back
6½" × 13" × 10"
Cord: 10' Brown



VG450-AB

Finish: Antique Brass
Height: 30"
Base: 5½"
Bulb: One 100W 3-way
Switch: On Socket
Shade: Off-white
Monaco Pleat Soft Back
6½" × 13" × 10"
Cord: 10' Brown

Windsor

Height: 61"
Base: 8"
Bulbs: One 150W 3-way
Switch: On Socket
Shade: 14" x 16" x 11"
Cord: 10' Brown

NOTE: Cord exits from adjustment arm.



W400-OB

Finish: Oil Rubbed Bronze
Shade: White Linen Hardback

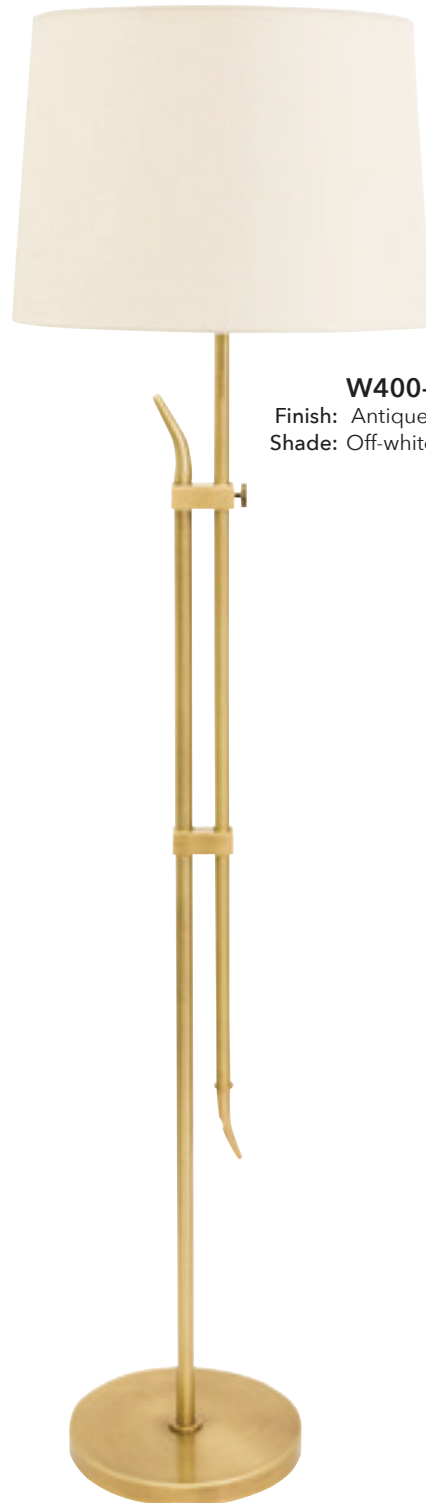

W400-AB

Finish: Antique Brass
Shade: Off-white Linen Hardback

Windsor

Height: 63" to 84"
Extension: 35"
Base: 13" Diameter
Bulbs: One 150W 3-way
Switch: On Socket
Shade: Off-white Linen Hardback
17" x 18" x 10"
Cord: 10' Brown

NOTE: Cord exits from adjustment arm.



W401-AB
Finish: Antique Brass



W401-OB
Finish: Oil Rubbed Bronze

Wall Sconces



Wall sconces add ambient light to any room. Small and narrow, they work well in a dining room, bath or hallway.

Wall Sconces

Height: 19"
Extension: 4" (ADA Compliant)
Backplate: 5"
LED: Integrated 2700K, 90 CRI, 4.5 Watts, 360 Lumens

DSCLEDZ19-91
Finish: Oil Rubbed Bronze

DSCLEDZ19-51
Finish: Satin Brass

DSCLEDZ19-52
Finish: Satin Nickel

DSCLEDZ19-71
Finish: Antique Brass

DSCLEDZ19-61
Finish: Polished Brass



WALL LAMPS

Height: 11"
Extension: 8¾"
Backplate: 3¼" x 5"
Bulb: One 60W B10
Switch: In-Line, 19" from Backplate
Shade: Off-white Linen Hardback
4" x 7¼" x 6"
Cord: 10' Clear

Plug-in Only



GR900-OB
Finish: Oil Rubbed Bronze



GR900-AB
Finish: Antique Brass

Wall Sconces

Height: 13"
Extension: 11¼"
Backplate: 5¼" Diameter
Bulb: One 75W Type A
Switch: In-Line, 19" from Backplate
Shade: Off-white Linen Hardback
6" x 9" x 7"
Cord: 10' Clear

Plug-in Only

GR901-OB
Finish: Oil Rubbed Bronze



GR901-AB
Finish: Antique Brass



WALL LAMPS

Height: 9"
Extension: 4"
Backplate: 9" x 5"
Bulb: 60B10
Shade: Clear Hurricane Glass
6½" x 2" x 1½"

LS201-MB
Finish: Mahogany Bronze



LS201-SP
Finish: Satin Pewter

Wall Sconces

Height: 17"
Extension: 7"
Backplate: 6"
Bulb: 60B10
Shade: 4" x 6" x 6"



LS202-MB
Finish: Mahogany Bronze
Shade: Natural Linen Hardback



LS202-AB
Finish: Antique Brass
Shade: Cream Linen Hardback



LS202-SP
Finish: Satin Pewter
Shade: White Linen Hardback

WALL LAMPS

Height: 9"
Extension: 4"
Backplate: 9" x 5"
Bulb: 60B10
Shade: Clear Seedy Glass Cylinder
6" x 3"



LS206-MB
Finish: Mahogany Bronze



LS206-SP
Finish: Satin Pewter



LS206-AB
Finish: Antique Brass

Wall Sconces

Height: 11½"
Extension: 8"
Backplate: 7" x 5"
Bulb: 60B10
Shade: 4" x 6" x 6"



LS217-AB
Finish: Antique Brass
Shade: Cream Linen Hardback



LS217-MB
Finish: Mahogany Bronze
Shade: Natural Linen Hardback



LS217-SP
Finish: Satin Pewter
Shade: White Linen Hardback

WALL LAMPS

Height: 10¼"
Extension: 4" (ADA Compliant)
Backplate: 2¾" x 4½"
Bulb: One 60T10
Shade: 7¾" x 1⅞"

Cover plate provided
for standard junction
box when necessary.



WL601-AB
Finish: Antique Brass
Shade: White Glass



WL601-OB
Finish: Oil Rubbed Bronze
Shade: Amber Glass



WL601-PC
Finish: Polished Chrome
Shade: White Glass



WL601-SN
Finish: Satin Nickel
Shade: White Glass

Wall Sconces

Height: 13¾"
Extension: 7½"
Backplate: 2¼" × 4½"
Bulb: One 60B10 Candelabra
Shade: 4⅛" × 7" × 5¾"

Cover plate provided
for standard junction
box when necessary.



WL609-SB

Finish: Satin Brass
Shade: Off-white Softback



WL609-SN

Finish: Satin Nickel
Shade: White Softback

WALL LAMPS

Height: 19"
Extension: 6"
Backplate: 4 1/8" square
Bulb: Two 60B10 Candelabra
Shade: 7 1/4" x 9 1/4" x 4 1/2"



WL616-CB
Finish: Copper Bronze
Shade: Off-White Softback



WL616-AB
Finish: Antique Brass
Shade: Off-White Softback



WL616-PB
Finish: Polished Brass
Shade: Off-White Softback

Wall Sconces

Height: 15"
Extension: 8"
Backplate: 4½" x 4½"
with 120V convenience outlet
Bulb: 60W medium
Switch: On Backplate
Shade: 6" x 6" x 7"



WL625-OB

Finish: Oil Rubbed Bronze
Shade: Off-white Linen Hardback



WL625-SN

Finish: Satin Nickel
Shade: White Linen Hardback

WALL LAMPS

Height: 16"
Extension: 16½"
Backplate: 6" x 2¾"
Bulb: 100W Type A
Switch: Pull Chain
Shade: Cream Linen Hardback
8" x 9" x 8"
Cord: 10' Clear

Available in pin up only



WL630-ABZ
Finish: Architectural Bronze



WL630-SN
Finish: Satin Nickel

Wall Sconces

Height: 11½"
Extension: 4" (ADA Compliant)
Backplate: 4½" x 4½"
Bulb: 40W B10
Shade: Cream Linen Hardback
(7" x 3½") x (7" x 3½") x 7"



WL631-ABZ
Finish: Architectural Bronze



WL631-SN
Finish: Satin Nickel

WALL LAMPS

Height: 11½"
Extension: 4" (ADA Compliant)
Backplate: 4½" x 8"
Bulb: Two 40W B10
Shade: Cream Linen Hardback
(14½" x 3½") x (14½" x 3½") x 7"



WL632-ABZ
Finish: Architectural Bronze



WL632-SN
Finish: Satin Nickel

Wall Swing Arms



Our Wall Swing Arm lamps are functional beside a bed or couch. They extend to allow for maximum adjustability. We offer various styles for all decors.

WALL LAMPS

Height: 5"
Extension: 27"
Backplate: 5" Diameter
Bulb: 75W Type A
Switch: On Socket
Shade: 5" x 8"
Cord: 10' Clear
30" Cord Cover

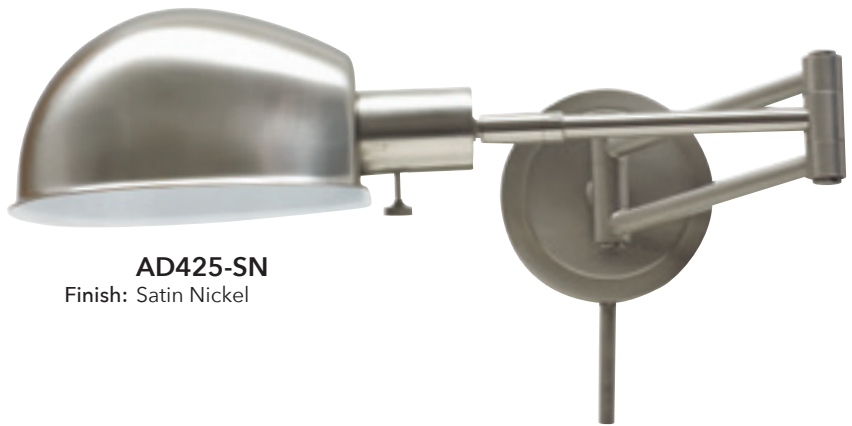

AD425-SN
Finish: Satin Nickel

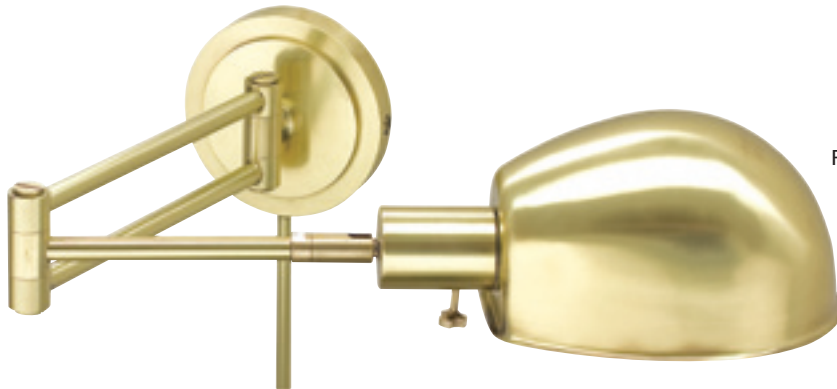

AD425-AB
Finish: Antique Brass



AD425-OB
Finish: Oil Rubbed Bronze

Wall Swing Arms

Height: 5"
Extension: 24"
Backplate: 5" Round
Bulb: One 100W Type A
Switch: On-Off on Socket
Shade: 8¾" x 3"
Cord: 10' Clear
30" Cord Cover



WS12-51-J
Finish: Satin Brass

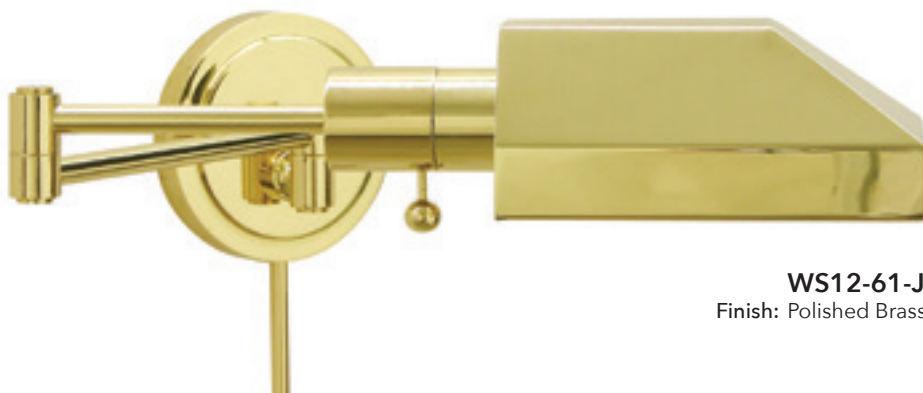

WS12-61-J
Finish: Polished Brass

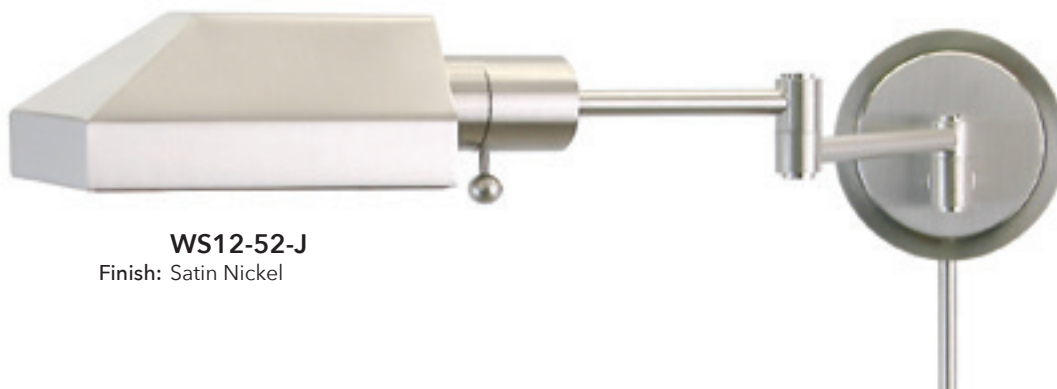

WS12-52-J
Finish: Satin Nickel

WALL LAMPS

Height: 5"
Extension: 24"
Backplate: 5" Round
Bulb: One 100W Type A
Switch: On-Off on Socket
Shade: 8¾" x 3"
Cord: 10' Clear
30" Cord Cover

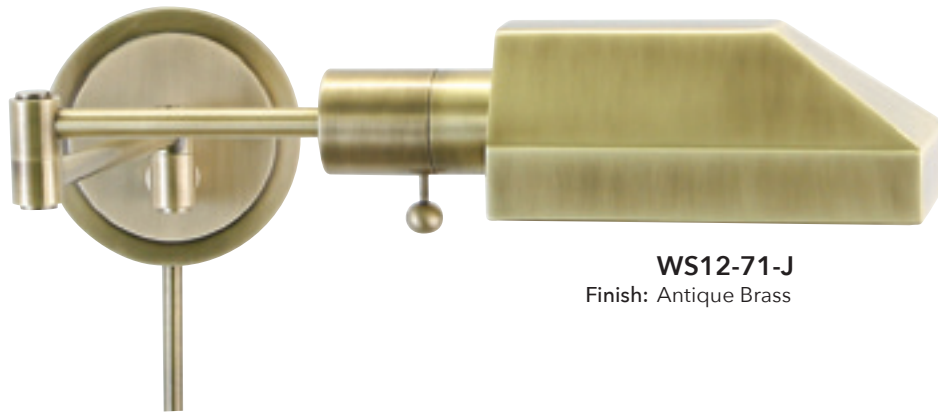

WS12-71-J
Finish: Antique Brass



WS12-91-J
Finish: Oil Rubbed Bronze

Wall Swing Arms

Height: 5"
Extension: 26"
Backplate: 5" Round
Bulb: One 60T10
Switch: On-Off on Socket
Shade: 10" x 2"
Cord: 10' Clear
30" Cord Cover

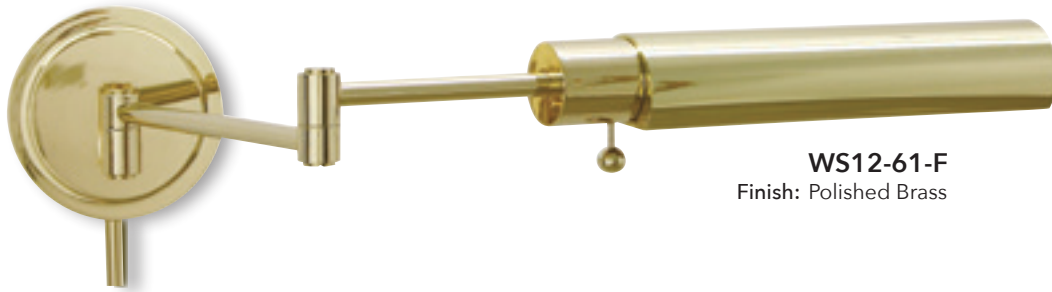

WS12-61-F
Finish: Polished Brass



WS12-52-F
Finish: Satin Nickel

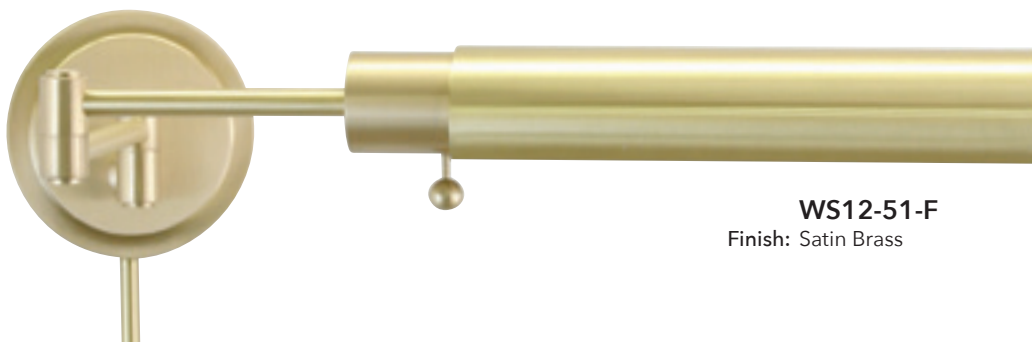

WS12-51-F
Finish: Satin Brass

WALL LAMPS

Height: 5"
Extension: 26"
Backplate: 5" Round
Bulb: One 60T10
Switch: On-Off on Socket
Shade: 10" x 2"
Cord: 10' Clear
30" Cord Cover

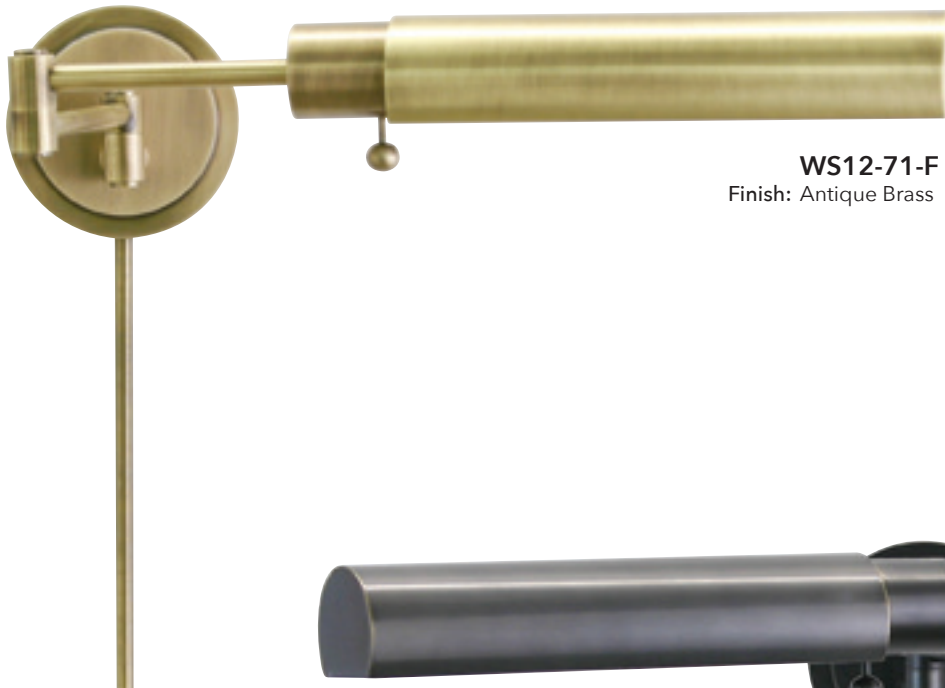

WS12-71-F
Finish: Antique Brass



WS12-91-F
Finish: Oil Rubbed Bronze

Wall Swing Arms

Height: 5"
Extension: 16½"
Base: 5"
Bulb: 60W Type A
Switch: On Socket
Shade: 2¼" x 10" x 4¾"
(Metal Shown MS)

Direct Wire Only

Glass Shade Options



Amber (AM)



Green (GR)



White (WT)



OT675-OB-MS
Finish: Oil Rubbed Bronze



OT675-AB-MS
Finish: Antique Brass



OT675-SN-MS
Finish: Satin Nickel

WALL LAMPS

Height: 5¼"
Extension: 20½"
Backplate: 5¼" Diameter
Bulb: One 50W GU10 Halogen (Included)
Switch: Full Range Dimmer in Shade
Shade: 6½" x 1½"
Cord: 10' Ivory
30" Cord Cover



G175-GT
Finish: Granite



G175-WT
Finish: White



G175-CHB
Finish: Chestnut Bronze

Wall Swing Arms

Height: 5½"
Extension: 23¾"
Backplate: 5" Square
Bulb: One 50W GU10 Halogen (Included)
Switch: Full Range Dimmer on Shade
Shade: 6½" × 2¼"
Cord: 10' Ivory
30" Cord Cover



PIN475-AB
Finish: Antique Brass



PIN475-OB
Finish: Oil Rubbed Bronze



PIN475-SN
Finish: Satin Nickel

WALL LAMPS

Height: 5½"
Extension: 21"
Backplate: 5½"
LED: Integrated 3000K, 80 CRI, 6 Watts, 500 Lumens
Switch: Touch Dimmer on Shade
Shade: 2" x 4"
Cord: 10' Clear with Plug-in Driver,
with 30" cord cover

Plug-in Only

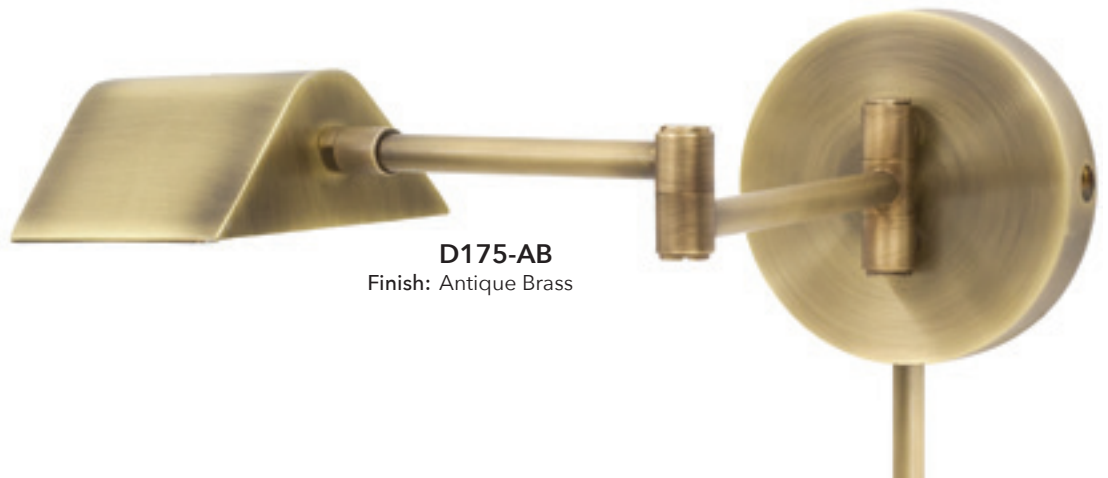

D175-AB
Finish: Antique Brass



D175-OB
Finish: Oil Rubbed Bronze



D175-SN
Finish: Satin Nickel

Wall Swing Arms

Height: 5"
Extension: 24½"
Backplate: 5" x 5"
LED: Integrated 3000K, 85 CRI, 4.5 Watts, 500 Lumens
Switch: On Shade
Shade: 11¼" x ¾"
Cord: 30" Cord Cover

G375-CHB
Finish: Chestnut Bronze
Cord: 10' Ivory

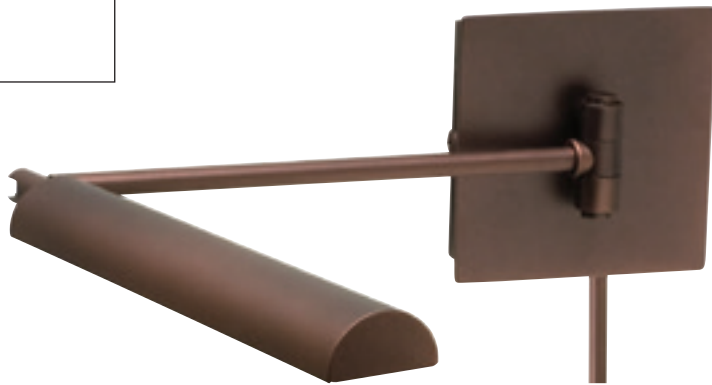

G375-BLK
Finish: Black
Cord: 10' Ivory



G375-WT
Finish: White
Cord: 10' White



G375-GT
Finish: Granite
Cord: 10' Ivory



WALL LAMPS

Height: 5"
Extension: 17¾"
Base: 7"
LED: Integrated 3000K, 80 CRI, 6 Watts, 500 Lumens
Switch: Touch Dimmer on Shade
Shade: 4" x 1¾"
Cord: 10' Clear with Plug-in Driver
30" Cord Cover

Plug-in Only



G475-ABZ
Finish: Architectural Bronze

G475-PG
Finish: Platinum Gray



G475-GT
Finish: Granite

Wall Swing Arms

Height: 5"
Extension: 17 $\frac{3}{4}$ "
Base: 7"
LED: Integrated 3000K, 80 CRI, 6 Watts, 500 Lumens
Switch: Touch Dimmer on Shade
Shade: 4" x 1 $\frac{3}{8}$ "
Cord: 10' Clear with Plug-in Driver
30" Cord Cover

Plug-in Only



G475-BLK
Finish: Black



G475-WT
Finish: White

WALL LAMPS

Height: 5"
Backplate: 5" x 5"
Extension: 22¼"
LED: Integrated 2900K, 96 CRI, 6.8 Watts, 800 Lumens
Switch: On Shade
Shade: 2½" x 5"
Cord: 10' Clear with Plug-in Driver
30" Cord Cover

Plug-in Only



G575-BLK
Finish: Black



G575-ABZ
Finish: Architectural Bronze



G575-PG
Finish: Platinum Gray



G575-WT
Finish: White

Wall Swing Arms

Height: 5"

Base: 5" x 5" with USB Port

LED: 3000K, 90+ CRI, 5 Watts, 545 Lumens Candelabra Base

Switch: On Shade

Shade: Metal

2" x 3" x 7"



NEW275-AB

Finish: Antique Brass

Cord: 10' Brown



NEW275-BLK

Finish: Black

Cord: 10' Black



NEW275-SN

Finish: Satin Nickel

Cord: 10' Clear

WALL LAMPS

Height: 6¼"
Backplate: 5"
Extension: 9½"
LED: Integrated 3000K, 80 CRI, 6.2 Watts, 600 Lumens
Switch: On Shade
Shade: 2¼" x 4¼" x 5½"
Cord: 10' Silver
30" Cord Cover



K175-BLK
Finish: Black



K175-GR
Finish: Gray



K175-WT
Finish: White

Wall Swing Arms

Height: 17¾"
Extension: 20½"
Backplate: 2¾" x 5¾"
Bulb: One 100W 3-way
Switch: On Socket
Shade: 6½" x 13" x 10"
Cord: 10' Clear
30" Cord Cover



CL225-AS
Finish: Antique Silver
Shade: White Softback



CL225-AB
Finish: Antique Brass
Shade: Off-white Softback



CL225-OB
Finish: Oil Rubbed Bronze
Shade: Off-white Softback

Cover plate provided for standard junction box when necessary, as shown on CL225-AB.

WALL LAMPS

Height: Adjusts 8" to 18"
Extension: 18"
Backplate: 4½" x 6½"
Bulb: 100W 3-way
Switch: On Socket
Shade: 10" x 12" x 8"
Cord: 8' Clear

Plug-in Only



CR725-AB
Finish: Antique Brass
Shade: Off-white Linen
Hardback



CR725-OB
Finish: Oil Rubbed Bronze
Shade: Off-white Linen
Hardback



CR725-SN
Finish: Satin Nickel
Shade: White Linen
Hardback

Wall Swing Arms

Height: 12½"
Extension: 27"
Backplate: 18" × 4⅛" × ⅝"
Bulb: Two 100W 3-way
Switch: On Socket

Shade: 6½" × 12" × 7"
Attaches with Acrylic Diffuser
Cord: 10' Clear
30" Cord Cover



WS14-2-71
Finish: Antique Brass
Shade: Off-white Linen Hardback



WS14-2-52
Finish: Satin Nickel
Shade: White Linen Hardback



WS14-2-91
Finish: Oil Rubbed Bronze
Shade: Off-white Linen Hardback

WALL LAMPS

Height: 12"
Extension: 27"
Backplate: 5" Round
Bulb: One 100W 3-way
Switch: On Socket
Shade: 6½" x 12" x 7"
Attaches with Acrylic Diffuser
Cord: 10' Clear
30" Cord Cover



WS14-51
Finish: Satin Brass
Shade: Off-white Linen
Hardback



WS14-52
Finish: Satin Nickel
Shade: White Linen
Hardback



WS14-61
Finish: Polished Brass
Shade: Off-white Linen Hardback

Wall Swing Arms

Height: 12"
Extension: 27"
Backplate: 5" Round
Bulb: One 100W 3-way
Switch: On Socket
Shade: 6½" x 12" x 7"
Attaches with Acrylic Diffuser
Cord: 10' Clear
30" Cord Cover



WS14-71
Finish: Antique Brass
Shade: Off-white Linen Hardback



WS14-9
Finish: White
Shade: White Linen Hardback



WS14-91
Finish: Oil Rubbed Bronze
Shade: Off-white Linen Hardback

WALL LAMPS

Height: 12½"
Extension: 20"
Backplate: 5" Round
Switch: Full Range Dimmer on Backplate
Cord: 10' Ivory
30" Cord Cover



HP725-OB-WL

Finish: Oil Rubbed Bronze
Bulb: One 100W Type A
Shade: Off-white Linen Hardback
5" x 9" x 7"



HP725-OB-MSOB

Finish: Oil Rubbed Bronze
Bulb: One 100W Type A
Shade: Metal
5" x 7½" x 6¼"



HP725-OB-BP

Finish: Oil Rubbed Bronze
Bulb: One 100W Type A
Shade: Black Parchment
5" x 9" x 7"

Wall Swing Arms

Height: 12½"
Extension: 20"
Backplate: 5" Round
Switch: Full Range Dimmer on Backplate
Cord: 10' Ivory
30" Cord Cover



HP725-WB-MSWB

Finish: Weathered Bronze
Bulb: One 100W Type A
Shade: Metal 5" × 7½" × 6¼"



HP725-WB-WL

Finish: Weathered Brass
Bulb: One 100W Type A
Shade: Off-white Linen Hardback
5" × 9" × 7"

HP725-WB-BP

Finish: Weathered Brass
Bulb: One 100W Type A
Shade: Black Parchment
5" × 9" × 7"



WALL LAMPS

Height: 12"
Extension: 25"
Backplate: 4½" x 4½" Square
Bulb: One 100W Type A
Switch: Remote on Wall
Shade: 5" x 9" x 7"

Direct Wire Only



DL20-OB
Finish: Oil Rubbed Bronze
Shade: Off-white Linen
Hardback



DL20-WB
Finish: Weathered Brass
Shade: Black Parchment

Wall Swing Arms

Height: 12½"
Extension: 26"
Backplate: 5" Round
Bulb: One 100W Type A
Switch: Full Range Dimmer on Backplate
Shade: 5" x 9" x 7"
Cord: 10' Ivory
30" Cord Cover

PL20-WB
Finish: Weathered Brass
Shade: Black Parchment



PL20-OB
Finish: Oil Rubbed Bronze
Shade: Off-white Linen Hardback

WALL LAMPS

Height: 13"
Extension: 11½"
Backplate: 1¾" x 3½"
Bulb: One 60W Medium Base
Switch: On Socket
Shade: 5" x 10" x 6¾"
Cord: 11' Clear
30" Cord Cover

Plug-in Only



LL660-AB
Finish: Antique Brass
Shade: Off-white Softback



LL660-OB
Finish: Oil Rubbed Bronze
Shade: Off-white Softback



LL660-PB
Finish: Polished Brass
Shade: Off-white Softback

Wall Swing Arms

Height: 27"
Backplate: 4½" x 6"
Bulb: One 75W Type A
Switch: On Socket
Shade: Metal
5" x 9" x 7"
Cord: 10" Clear
30" Cord Cover



M675-BLKAB
Finish: Black with Antique Brass

M675-BLKPN
Finish: Black with Polished Nickel

LED: Integrated 2900K, 96 CRI, 6.8 Watts, 800 Lumens
Height: 5"
Backplate: 5" x 5"
Extension: 19"
Switch: On Shade
Shade: Metal
2½" x 5½"
Cord: 10' Clear with Plug-in Driver

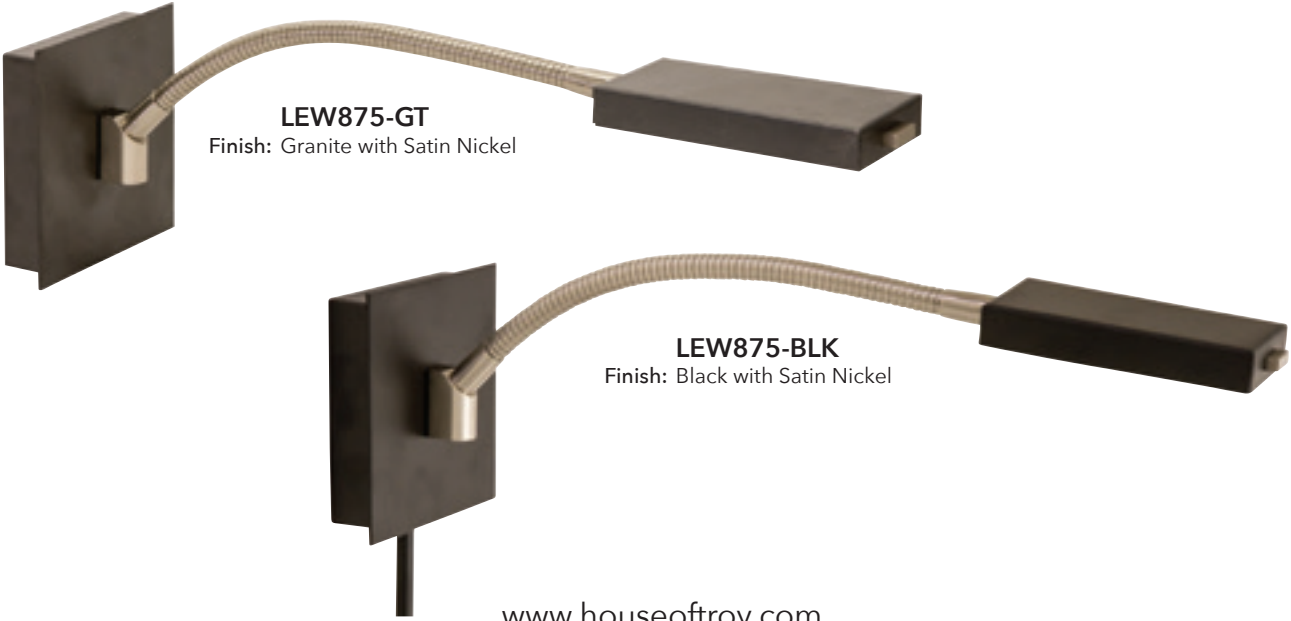

LEW875-GT
Finish: Granite with Satin Nickel

LEW875-BLK
Finish: Black with Satin Nickel

WALL LAMPS

Height: 15"
Extension: Extends 26"
Backplate: 5" Round
Bulb: One 100W 3-way
Switch: On Socket
Shade: Off-white Linen Hardback
10" x 12" x 9"
Cord: 10' Clear
30" Cord Cover

TH725-OB
Finish: Oil Rubbed Bronze



TH725-PN
Finish: Polished Nickel



TH725-RB
Finish: Raw Brass



Wall Swing Arms

Height: 15½"
Extension: 25"
Backplate: 6" x 4½"
Bulb: One 100W Type A
Switch: On Socket
Shade: 5½" x 12½" x 9¼"
Cord: 11' Clear
30" Cord Cover

WS16-91

Finish: Oil Rubbed Bronze
Shade: Off-white Linen
Hardback



WS16-31

Finish: Pewter
Shade: White Linen Hardback



WS16-61

Finish: Polished Brass
Shade: Off-white Linen Hardback



WALL LAMPS

Height: 16½"
Extension: 25"
Backplate: 6¼" x 3½"
Bulb: One 100W 3-way
Switch: On Socket
Shade: 5½" x 12" x 8½"
Cord: 11' Ivory
30" Cord Cover

WS706
Finish: Polished Brass
Shade: Off-white Softback



WS706-AB
Finish: Antique Brass
Shade: Off-white Softback



WS706-OB
Finish: Oil Rubbed Bronze
Shade: Off-white Softback



Wall Swing Arms



WS704

Finish: Polished Brass
Height: 13"
Extension: 25"
Backplate: 6¼" x 3½"
Bulb: One 100W Type A
Switch: Full Range Dimmer on Socket
Shade: Off-white Linen Hardback with Diffuser
7" x 13½" x 7½"
Cord: 11' Ivory
30" Cord Cover



WS708-OB

Finish: Oil Rubbed Bronze
Height: 16"
Extension: 25"
Backplate: 6¼" x 3½"
Bulb: One 100W Type A
Switch: Hi-Lo on Backplate
Shade: Off-white Softback
5½" x 12" x 8½"
Cord: 11' Ivory
30" Cord Cover

WS708-AB

Finish: Antique Brass
Height: 16"
Extension: 25"
Backplate: 6¼" x 3½"
Bulb: One 100W Type A
Switch: Hi-Lo on Backplate
Shade: Off-white Softback
5½" x 12" x 8½"
Cord: 11' Ivory
30" Cord Cover



WALL LAMPS

Height: 15"
Extension: 27"
Backplate: 5" x 6"
Bulb: One 100W 3-way
Switch: On Socket
Shade: 6" x 11" x 8"
Cord: 11' Clear
30" Cord Cover



WS750-OB

Finish: Oil Rubbed Bronze
Shade: Off-white Linen Hardback



WS750-AS

Finish: Antique Silver
Shade: White Linen Hardback



WS750-AB

Finish: Antique Brass
Shade: Off-white Linen Hardback

Wall Swing Arms

Height: 15"
Extension: 23"
Backplate: 6" x 6"
Bulb: One 100W 3-way
Switch: On Socket
Shade: 6" x 9" x 8½"
Cord: 11' Clear
30" Cord Cover



WS751-AB

Finish: Antique Brass
Shade: Off-white Linen Hardback



WS751-OB

Finish: Oil Rubbed Bronze
Shade: Off-white Linen Hardback



WS751-AS

Finish: Antique Silver
Shade: White Linen Hardback

WALL LAMPS

Height: 14"
Extension: 25"
Backplate: 4¾" x 4¾"
Bulb: One 100W 3-way
Switch: On Socket
Shade: 8" x 9" x 8"
Cord: 11' Clear
30" Cord Cover

WS752-OB

Finish: Oil Rubbed Bronze
Shade: Off-white Linen Hardback



WS752-AS

Finish: Antique Silver
Shade: White Linen Hardback



WS752-AB

Finish: Antique Brass
Shade: Off-white Linen Hardback

Wall Swing Arms

Height: 15½"
Extension: 26"
Backplate: 4½" x 6" Rectangle
Bulb: One 100W Type A
Switch: On Socket
Shade: 6½" x 13" x 10"
Cord: 10' Clear
30" Cord Cover



WS760-AS
Finish: Antique Silver
Shade: White Pleat Softback



WS760-OB
Finish: Oil Rubbed Bronze
Shade: Off-white Pleat Softback



WS760-AB
Finish: Antique Brass
Shade: Off-white Pleat Softback

WALL LAMPS

Height: 18"
Extension: 25"
Backplate: 4½" x 6" Rectangle
Bulb: One 100W Type A
Switch: On Socket
Shade: 6½" x 12" x 9½"
Cord: 10' Clear
30" Cord Cover

WS761-OB
Finish: Oil Rubbed Bronze
Shade: Off -white Linen Softback



WS761-AS
Finish: Antique Silver
Shade: Beligan White Linen Softback



WS761-AB
Finish: Antique Brass
Shade: Off -white Linen Softback

Wall Swing Arms

Height: 15"
Extension: 26"
Backplate: 4½" x 6" Rectangle
Bulb: One 100W Type A
Switch: On Socket
Shade: 6½" x 12" x 9"
Cord: 10' Clear
30" Cord Cover

WS763-AB
Finish: Antique Brass
Shade: Off-white Linen Hardback



WS763-OB
Finish: Oil Rubbed Bronze
Shade: Natural Linen Hardback



WS763-AS
Finish: Antique Silver
Shade: Belgian White Linen Hardback

WALL LAMPS

Height: 15"
Extension: 24"
Backplate: 5"
Bulb: 100W 3-way
Switch: On Socket
Shade: 8" x 8" x 9"
Cord: 11' Clear
30" Cord Cover



WS775-SN
Finish: Satin Nickel
Shade: White Linen Hardback



WS775-OB
Finish: Oil Rubbed Bronze
Shade: Off-white Linen Hardback

Wall Swing Arms

Height: 12½"
Extension: 25½"
Backplate: 4½" x 6"
Bulb: 100W medium
Switch: Full Range Dimmer on Backplate
Shade: 11½" x 12" x 6" with Diffuser
Cord: 11' Clear
30" Cord Cover



WS776-OB

Finish: Oil Rubbed Bronze
Shade: Off-white Linen Hardback



WS776-PN

Finish: Polished Nickel
Shade: White Linen Hardback

Desk/Piano Lamps



House of Troy desk/upright piano lamps illuminate any task with efficiency and classic good looks. Features include multiple points of adjustment, base switching and excellent light output.

Desk/Piano Lamps



AP10-20-71

Finish: Antique Brass
Height: Maximum 11½"
Base: 5" Round
Bulb: One 40T10
Switch: On Shade
Shade: 10"
Cord: 9' Brown



AP10-20-61

Finish: Polished Brass
Height: Maximum 11½"
Base: 5" Round
Bulb: One 40T10
Switch: On Shade
Shade: 10"
Cord: 9' Brown



AP10-20-7

Finish: Black
Height: Maximum 11½"
Base: 5" Round
Bulb: One 40T10
Switch: On Shade
Shade: 10"
Cord: 9' Black



AP10-25-7

Finish: Black
Height: Maximum 10"
Base: 6" Round
Bulb: One 40T10
Switch: On Shade
Shade: 10"
Cord: 9' Black

DESK/PIANO LAMPS

Height: Maximum 10½"
Base: 5" Round
Bulb: One 40T10
Switch: On Shade
Shade: 10"



AP10-21-7
Finish: Black
Cord: 9' Black



AP10-21-91
Finish: Oil Rubbed Bronze
Cord: 9' Brown



AP10-21-61
Finish: Polished Brass
Cord: 9' Brown



AP10-21-71
Finish: Antique Brass
Cord: 9' Brown

Desk/Piano Lamps

Height: Maximum 12½"
Base: 6" round
Bulb: Two 40T10
Switch: In-Line 6" from base
Shade: 14"



AP14-40-7
Finish: Black
Cord: 9' Black



AP14-40-71
Finish: Antique Brass
Cord: 9' Brown



AP14-40-61
Finish: Polished Brass
Cord: 9' Brown

DESK/PIANO LAMPS

Height: Maximum 12"
Base: 6" round
Bulb: Two 40T10
Switch: In-Line 6" from base
Shade: 14"



AP14-41-71

Finish: Antique Brass
Cord: 9' Brown



AP14-41-61

Finish: Polished Brass
Cord: 9' Brown



AP14-41-7

Finish: Black
Cord: 10' Black

Desk/Piano Lamps



AP14-41-91

Finish: Oil Rubbed Bronze
Height: Maximum 12"
Base: 6" Round
Bulb: Two 40T10
Switch: In-Line 6" from base
Shade: 14"
Cord: 9' Black



AP14-42-61

Finish: Polished Brass with
Black Marble
Height: Maximum 13¼"
Base: 6" Round
Bulb: Two 40T10
Switch: In-Line 6" from base
Shade: 14"
Cord: 9' Brown



AP14-45-7

Finish: Black
Height: Maximum 10"
Base: 6" Round
Bulb: Two 40T10
Switch: In-Line
Shade: 14"
Cord: 9' Black

DESK/PIANO LAMPS

Height: 13¾"
Base: 5" Square
Bulb: One 60T10
Switch: On Base
Cord: 9' Brown



DSK428-G71
Finish: Antique Brass
Shade: 9" Green Glass



DSK428-G61
Finish: Polished Brass
Shade: 9" Green Glass



DSK430-MB
Finish: Mahogany
Bronze & Black
and Tan Marble
Shade: 9" Amber Glass

Desk/Piano Lamps

Height: 12½"
Base: 5" Square
Bulb: 60T10
Switch: On Base
Shade: 12"



DSK440-ABMB
Finish: Antique Brass with Mahogany Bronze Accents and Black and Tan Marble
Cord: 10' Brown



DSK440-MBAC
Finish: Mahogany Bronze with Antique Copper Accents and Black and Tan Marble
Cord: 10' Brown

Marble is a natural material and therefore, each piece will have variations.



DSK440-SNBLK
Finish: Satin Nickel with Black Accents and Black Marble
Cord: 10' Clear

DESK/PIANO LAMPS

Height: Maximum 14"
Base: 5¾" Octagon
Bulb: One 40T10 or 60T10
Switch: On Shade
Shade: 10"
Cord: 9' Brown



P10-111-71
Finish: Antique Brass



P10-101-B
Finish: Polished Brass & Black Marble
Height: Maximum 12"
Base: 4½" Square
Bulb: One 40T10 or 60T10
Switch: On Shade
Shade: 10"
Cord: 9' Brown



P10-111-MB
Finish: Mahogany Bronze



P10-111
Finish: Polished Brass

Desk/Piano Lamps



P10-130

Finish: Polished Brass
Height: Maximum 11"
Base: 5" Round
Bulb: One 40T10 or 60T10
Switch: On Shade
Shade: 10"
Cord: 9' Brown



P10-123-81

Finish: Mahogany Bronze
Height: Maximum 11"
Base: 5" Round
Bulb: One 40T10 or 60T10
Switch: On Shade
Shade: 10"
Cord: 9' Brown



P10-131-61

Finish: Polished Brass
Height: Maximum 10½"
Base: 5" Round
Bulb: One 40T10 or 60T10
Switch: On Shade
Shade: 10"
Cord: 9' Brown



P10-131-71

Finish: Antique Brass
Height: Maximum 10½"
Base: 5" Round
Bulb: One 40T10 or 60T10
Switch: On Shade
Shade: 10"
Cord: 9' Brown

DESK/PIANO LAMPS

Height: Maximum 14"
Base: 6" Square
Bulb: Two 40T10 or 60T10
Switch: On Base
Shade: 14"
Cord: 9' Brown



P14-201
Finish: Polished Brass



P14-201-GT
Finish: Granite



P14-201-AB
Finish: Antique Brass



P14-201-81
Finish: Mahogany Bronze

Desk/Piano Lamps

Height: Maximum 14"
Base: 6" Square
Bulb: Two 40T10 or 60T10
Switch: On Base
Shade: 14"



PB14-201-MB/AB
Finish: Mahogany Bronze with
Antique Brass Accents
Cord: 9' Brown



PR14-201-BLK/PN
Finish: Black with
Polished Nickel Accents
Cord: 9' Black



PS14-201-AB/PB
Finish: Antique Brass with
Polished Brass Accents
Cord: 9' Brown

DESK/PIANO LAMPS

Height: Maximum 13"
Base: 5" Square
Bulb: Two 40T10 or 60T10
Switch: On Base
Shade: 14"
Cord: 9' Brown



P14-202-81
Finish: Mahogany Bronze



P14-202
Finish: Polished Brass



P14-202-AB
Finish: Antique Brass

Desk/Piano Lamps

Height: Maximum 13"
Base: 5" Square
Bulb: Two 40T10 or 60T10
Switch: On Base
Shade: 14"



PB14-202-BLK/PN
Finish: Black with
Polished Nickel Accents
Cord: 9' Black



PS14-202-MB/AB
Finish: Mahogany Bronze with
Antique Brass Accents
Cord: 9' Brown



PR14-202-AB/PB
Finish: Antique Brass with
Polished Brass Accents
Cord: 9' Brown

DESK/PIANO LAMPS

Height: Maximum 12½"
Base: 6" Octagon
Bulb: Two 40T10 or 60T10
Switch: On Base
Shade: 14"
Cord: 9' Brown



P14-203-81
Finish: Mahogany Bronze



P14-203
Finish: Polished Brass



P14-203-AB
Finish: Antique Brass

Desk/Piano Lamps

Height: Maximum 12½"
Base: 6" Octagon
Bulb: Two 40T10 or 60T10
Switch: On Base
Shade: 14"



PR14-203-MB/AB
Finish: Mahogany Bronze with
Antique Brass Accents
Cord: 9' Brown



PB14-203-AB/PB
Finish: Antique Brass with
Polished Brass Accents
Cord: 9' Brown



PS14-203-BLK/PN
Finish: Black with
Polished Nickel Accents
Cord: 9' Brown



DESK/PIANO LAMPS

Height: Maximum 15"
Base: 6¼" Round
Bulb: Two 40T10 or 60T10
Switch: On Base
Shade: 14"
Cord: 9' Brown



P14-204
Finish: Polished Brass



P14-204-81
Finish: Mahogany Bronze



P14-204-AB
Finish: Antique Brass

Desk/Piano Lamps



P14-232-C71
Finish: Antique Brass
& Chestnut Bronze
Height: Maximum 14¾"
Base: 5½" Square
Bulb: Two 40T10 or 60T10
Switch: On Base
Shade: 14"
Cord: 9' Brown



P14-231-71
Finish: Antique Brass
Height: Maximum 12"
Base: 6" Round
Bulb: Two 40T10 or 60T10
Switch: In-Line 6" from base
Shade: 14"
Cord: 9' Brown



P14-231-61
Finish: Polished Brass
Height: Maximum 12"
Base: 6" Round
Bulb: Two 40T10 or 60T10
Switch: In-Line 6" from base
Shade: 14"
Cord: 9' Brown

DESK/PIANO LAMPS



P14-233-617

Finish: Black with Polished
Brass Accents
Height: Maximum 16½"
Base: 5½" Square
Bulb: Two 40T10 or 60T10
Switch: On Base
Shade: 14"
Cord: 9' Black



P14-233-C71

Finish: Antique Brass
& Chestnut Bronze
Height: Maximum 16½"
Base: 5½" Square
Bulb: Two 40T10 or 60T10
Switch: On Base
Shade: 14"
Cord: 9' Brown



P14-242-71

Finish: Antique Brass
Height: Maximum 16"
Base: 6 3/8" round
Bulb: Two 40T10 or 60T10
Switch: In-Line 6" from base
Shade: 14"
Cord: 9' Brown

Desk/Piano Lamps

Marble is a natural material and therefore, each piece will have variations.



P1581-5262

Finish: Satin Nickel with Polished Chrome Column
Height: Maximum 18"
Base: 5½" Square
Bulb: Two 40T10
Switch: On Base
Shade: 15"
Cord: 9' Clear



P15-83-52

Finish: Satin Nickel
Height: Maximum 16"
Base: 5¾" Square
Bulb: Two 40T10
Switch: On Base
Shade: 15"
Cord: 9' Clear



P14-280

Finish: Mahogany Bronze & Black & Tan Marble
Height: Maximum 12"
Base: 5½" Square
Bulb: Two 40T10 or 60T10
Switch: On Base
Shade: 14"
Cord: 9' Brown



P14-280-WB

Finish: Weathered Brass & Black & Tan Marble
Height: Maximum 12"
Base: 5½" Square
Bulb: Two 40T10 or 60T10
Switch: On Base
Shade: 14"
Cord: 9' Brown

DESK/PIANO LAMPS

Height: 12½"
Base: 5" Square
Bulb: Two 60T10
Switch: On Base
Shade: 14"



P14-290-ABMB

Finish: Antique Brass with
Mahogany Bronze Accents
and Black and Tan Marble
Cord: 10' Brown



P14-290-MBAC

Finish: Mahogany Bronze with
Antique Copper Accents and
Black and Tan Marble
Cord: 10' Brown



P14-290-SNBLK

Finish: Satin Nickel with Black Accents
and Black Marble
Cord: 10' Clear

Specialty Piano Lamps



Every music teacher will tell you how important good lighting is when reading music. Our piano lamps are designed to accommodate all styles of acoustic pianos, from Upright to Grand.

UPRIGHT PIANO LAMPS



P10-150

Finish: Polished Brass
Height: Maximum 8"
Extension: 9"
Base: 6" Round
Bulb: One 40T10 or 60T10
Switch: On Shade
Shade: 10"
Cord: 9' Brown

P14-250

Finish: Polished Brass
Height: Maximum 8"
Extension: 9"
Base: 6" Round
Bulb: Two 40T10 or 60T10
Switch: In-Line 6" from base
Shade: 14"
Cord: 9' Brown



P10-150-617

Finish: Black with Polished Brass Accents
Height: Maximum 8"
Extension: 9"
Base: 6" Round
Bulb: One 40T10 or 60T10
Switch: On Shade
Shade: 10"
Cord: 9' Black

P14-250-617

Finish: Black with Polished Brass Accents
Height: Maximum 8"
Extension: 9"
Base: 6" Round
Bulb: Two 40T10 or 60T10
Switch: In-Line 6" from base
Shade: 14"
Cord: 9' Black



PH10-170-PB

Finish: Polished Brass
Height: Maximum 6"
Extension: 8½"
Base: 6" Round
Bulb: 50W GU10 Halogen (Included)
Switch: Full Range Dimmer on Shade
Shade: 10"
Cord: 10' Black

Specialty Piano Lamp

Height: 4"
Extension: 5¼"
Base: 5¼" Round
LED: Integrated 3000K, 80 CRI, 4.7 Watts, 200 Lumens
Switch: In-Line 6" from base
Shade: 19"
Cord: 10' with Plug-in Driver



PLED101-527
Finish: Black with
Satin Nickel Accents



PLED101-61
Finish: Polished Brass



PLED101-617
Finish: Black with
Brass Accents

UPRIGHT PIANO LAMPS

Height: 4½"
Extension: 8"
Base: 7"
LED: Integrated 3000K, 85 CRI, 4.5 Watts, 500 Lumens
Switch: Full Range Dimmer on Base
Shade: 12"

PZLEDZ101-52

Finish: Satin Nickel
Cord: 10' Clear



PZLEDZ101-7

Finish: Black
Cord: 10' Black



PZLEDZ101-71

Finish: Antique Brass
Cord: 10' Brown



Specialty Piano Lamp

Height: 15"
Base: 3½" x 7" Rectangle
Bulb: Two 40T10 or 60T10
Switch: In-Line 6" from base
Shade: 14"
Cord: 9" Black



P14-DO1
Finish: Polished Brass & Black



P16-DO2-627
Finish: Chrome and Black



P16-DO2-617
Finish: Polished Brass and Black

DIGITAL PIANO LAMPS

Height: 16"
Base: 5¼" Diameter
LED: Integrated 3000K, 80 CRI, 4.7 Watts, 200 Lumens
Switch: In-Line 6" from base
Shade: 19"
Cord: 10' Black with Plug-in Driver



PLED100-61
Finish: Polished Brass



PLED100-527
Finish: Black with Satin
Nickel Accents



PLED100-617
Finish: Black with
Polished Brass Accents

Specialty Piano Lamps

Height: 14"
Extension: 8"
Base: 7"
LED: Integrated 3000K, 85 CRI, 4.5 Watts, 500 Lumens
Switch: Full Range Dimmer on Base
Shade: 12"



PZLEDZ100-52
Finish: Satin Nickel
Cord: 10' Clear



PZLEDZ100-71
Finish: Antique Brass
Cord: 10' Brown



PZLEDZ100-7
Finish: Black
Cord: 10' Black

DIGITAL AND BATTERY OPERATED PIANO LIGHTS

Height: 14"

Base: 3½" × 7" Rectangle

LED: Integrated 3000K, 75 CRI, 3.2 Watts, 88 Lumens

Switch: On Base

Shade: 14" Long

Batteries: 4 C (Not Included)
Illuminates 30 hours



BPLED200-81

Finish: Mahogany Bronze



BPLED200-617

Finish: Black and Brass

Specialty Piano Lamps

Height: 5½"
Extension: 4½"
Base: 4½" x 3" x 1¼"
LED: Integrated 3000K, 75 CRI, 3.2 Watts, 88 Lumens
Switch: On Base
Shade: 12½"
Batteries: 4C (not included)
Illuminates 48 hours
Clamp: Max Width 1"



CBLED12-7
Finish: Black



CBLED12-61
Finish: Polished Brass

BATTERY OPERATED AND GRAND PIANO CLAMP LAMPS

Height: Adjustable 8½" Gooseneck
Clamp: Felt-lined, 5½" x 2½"
adjusts from ½" to ¾"
Bulb: One 40T10 or 60T10
Switch: On Shade
Shade: 10"



GP10-81
Finish: Mahogany Bronze
Cord: 9' Brown



GP10-7
Finish: Black
Cord: 9' Black



GP10-61
Finish: Polished Brass
Cord: 9' Brown

Specialty Piano Lamps

Height: Adjustable 8½" Gooseneck

Clamp: Felt-lined, 5½" x 2½"
adjusts from ½" to ¾"

Bulb: Two 40T10 or 60T10

Switch: In-Line 3" from clamp

Shade: 14"



GP14-81

Finish: Mahogany Bronze
Cord: 9' Brown



GP14-7

Finish: Black
Cord: 9' Black



GP14-61

Finish: Polished Brass
Cord: 9' Brown

GRAND PIANO CLAMP LAMPS

Height: 5½"
Extension: 8½"
Clamp: Felt-lined, 5½" x 2½"
adjusts from ½" to ¾"
Bulb: 50W GU10 Halogen (included)
Switch: Full Range Dimmer on Shade
Shade: 10"
Cord: 10' Black



GPH10-PB
Finish: Polished Brass



GPH10-BLK
Finish: Black

Specialty Piano Lamps

Height: 7½" from top of clamp to top of arm
Extension: 5"
Clamp: 5½" × 2½" Felt-lined, adjusts up to ¾"
LED: Integrated 3000K, 80 CRI, 4.7 Watts, 200 Lumens
Switch: In-Line 6" from base
Shade: 19"
Cord: 10' Black with Plug-in Driver

GPLED19-61
Finish: Polished Brass

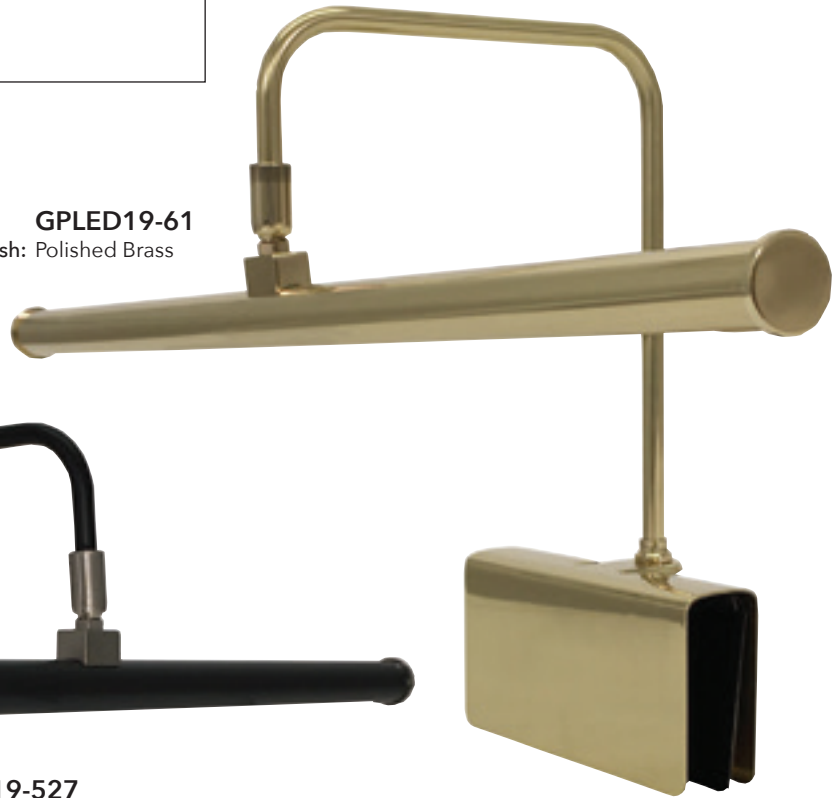

GPLED19-527
Finish: Black with Satin Nickel Accents



GPLED19-7
Finish: Black with Brass Accents



GRAND PIANO CLAMP LAMPS

Height: 4"
Extension: 5"
Clamp: 5½" × 2½" Felt-lined, adjusts up to ¾"
Base: 5½" × 2½"
LED: Integrated 3000K, 85 CRI, 4.5 Watts, 500 Lumens
Switch: In-Line, 3" from clamp



GPZLEDZ12-61

Finish: Polished Brass
Shade: 12"
Cord: 9' Brown



GPZLEDZ12-7

Finish: Black
Shade: 12"
Cord: 9' Black

Specialty Piano Lamps

Height: 4"
Extension: 5"
Clamp: 5½" × 2½" Felt-lined, adjusts up to ¾"
Base: 5½" × 2½"
LED: Integrated 3000K, 85 CRI, 4.5 Watts, 500 Lumens
Switch: In-Line, 3" from clamp

GPZLEDZ24-61

Finish: Polished Brass
Shade: 24"
Cord: 9' Brown



GPZLEDZ24-7

Finish: Black
Shade: 24"
Cord: 9' Black



Height: 7½"
Extension: 5"
Clamp: 5½" × 2½" Felt-lined, adjusts up to ¾"
LED: Integrated 3000K, 85 CRI, 4.5 Watts, 500 Lumens
Switch: In-Line 6" from base
Shade: 19"
Cord: 10' Black with Plug-in Driver

GPLED26-7

Finish: Black



GRAND PIANO CLAMP LAMPS

Height: Adjustable
Extension: 8"
Clamp: Felt-lined, 5½" x 2½"
adjusts from ½" to ¾"
Bulb: Four 15T4
Switch: In-Line 3" from clamp
Shade: 1" x 22" Rotating

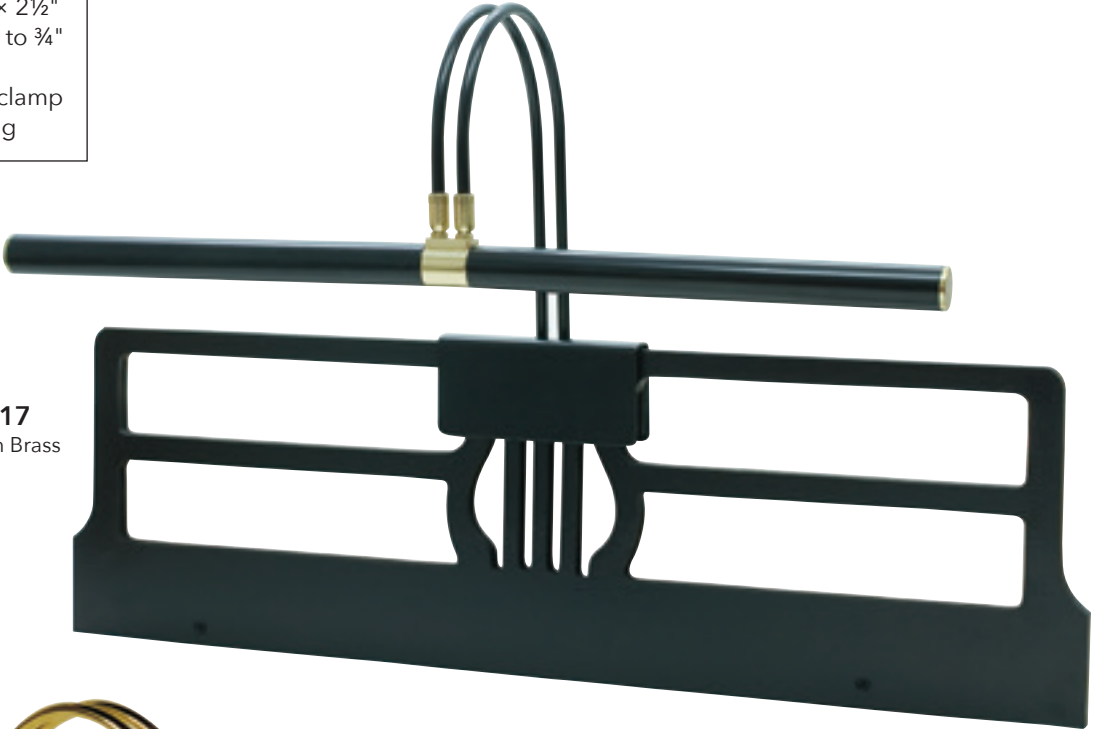

GPXL-617
Finish: Black with Brass
Accents
Cord: 10' Black



GPXL22-61
Finish: Polished Brass
Cord: 10' Brown



GPXL-627
Finish: Black with Chrome Accents
Cord: 10' Black

Specialty Piano Lamps

Height: Maximum 22"
Extension: 30"
Base: 6" x 7¼"
LED: Integrated 3000K, 85 CRI,
4.5 Watts, 500 Lumens
Switch: On Shade
Shade: 11¼"



G350-BLK
Finish: Black
Cord: 10' Black



G350-GT
Finish: Granite
Cord: 10' Black



G350-WT
Finish: White
Cord: 10' White



G350-CHB
Finish: Chestnut Bronze
Cord: 10' Brown

GRAND PIANO CLAMP/COUNTERBALANCE PIANO LAMPS

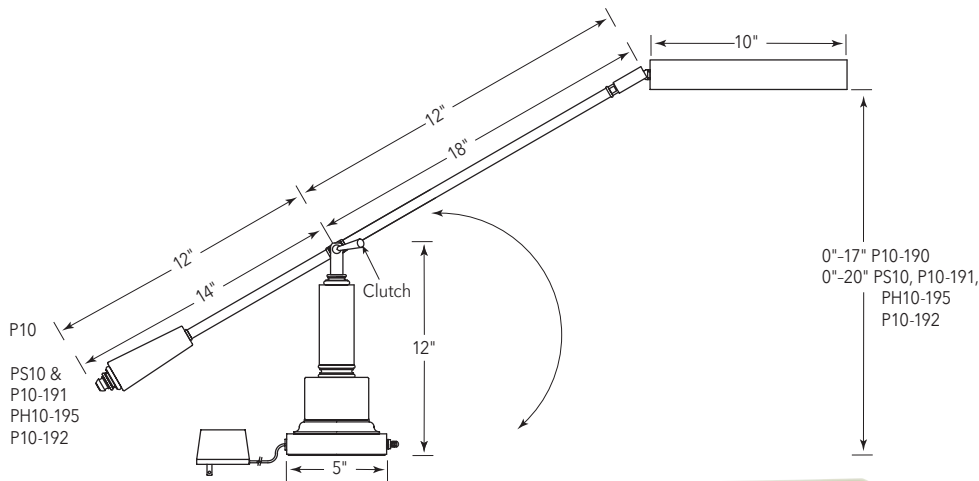

Marble is a natural material and therefore, each piece will have variations.

Specialty Piano Lamps

Height: Maximum 20"
Extension: 28"
Base: 5" Square
Bulb: 13W-PL fluorescent
Switch: On Base
Shade: 10"
Cord: 11' Black with Transformer



P10-191-61
Finish: Polished Brass



P10-191-81
Finish: Mahogany Bronze



P10-191-71
Finish: Antique Brass

GRAND PIANO COUNTERBALANCE LAMPS

Marble is a natural material and therefore, each piece will have variations.

Incandescent (shown)

P10-192-627

Finish: Chrome & Black
Height: Maximum 20"
Extension: 28"
Base: 6" Round
Bulb: One 40T10 or 60T10
Switch: On Socket
Shade: 10"
Cord: 9' Black



LED

PLED-192-627

Finish: Chrome & Black
Height: Maximum 20"
Extension: 28"
Base: 6" Round
LED: Integrated 3000K, 80 CRI, 4.5 Watts, 500 Lumens
Switch: On Shade
Shade: 12"
Cord: 9' Black



Incandescent

P10-192-617

Finish: Polished Brass & Black
Height: Maximum 20"
Extension: 28"
Base: 6" Round
Bulb: One 40T10 or 60T10
Switch: On Socket
Shade: 10"
Cord: 9' Black

LED (shown)

PLED-192-617

Finish: Polished Brass & Black
Height: Maximum 20"
Extension: 28"
Base: 6" Round
LED: Integrated 3000K, 85 CRI, 4.5 Watts, 500 Lumens
Switch: On Shade
Shade: 12"
Cord: 9' Black

Specialty Piano Lamps

Height: Maximum 20"
Extension: 28"
Base: 6" Diameter
Bulb: 50W GU10 Halogen (included)
Switch: Full Range Dimmer on Shade
Shade: 10"
Cord: 10' Brown



PH10-195-PB
Finish: Polished Brass



PH10-195-OB
Finish: Oil Rubbed Bronze



PH10-195-AB
Finish: Antique Brass

GRAND PIANO COUNTERBALANCE LAMPS

LED

PFLED-617

Finish: Black & Polished Brass
Height: Maximum 54"
Extension: 39½"
Base: 10" Round
Bulb: Integrated 3000K, 85 CRI,
4.5 Watts, 500 Lumens
Switch: On Socket
Shade: 12"
Cord: 10' Black



Incandescent (shown)

PFL-617

Finish: Black & Polished Brass
Height: Maximum 54"
Extension: 39½"
Base: 10" Round
Bulb: One 60T10
Switch: On Socket
Shade: 10"
Cord: 10' Black

Also available in Black & Satin Nickel



FL10-MB

Finish: Mahogany Bronze
Height: Maximum 54"
Extension: 41½"
Base: 10" Diameter
Bulb: One 60T10
Switch: On Shade
Shade: 12" Metal
Cord: 10' Black



LED (shown)

PFLED-527

Finish: Black & Satin Nickel
Height: Maximum 54"
Extension: 41½"
Base: 10" Diameter
Bulb: Integrated 3000K, 85 CRI,
4.5 Watts, 500 Lumens
Switch: On Shade
Shade: 12" Metal
Cord: 10' Black

Incandescent

PFL-527

Finish: Black & Satin Nickel
Height: Maximum 54"
Extension: 41½"
Base: 10" Diameter
Bulb: One 60T10
Switch: On Shade
Shade: 12" Metal
Cord: 10' Black

Also available in Black & Polished Brass

Specialty Task Lamps

Lectern Lights

Designed to be permanently installed on surfaces up to 2" thick.



Plug-in Incandescent

L10-61

Finish: Polished Brass
Height: 7"
1 3/4" Between Arms
Bulb: One 40 or 60T10F
Switch: On Shade
Shade: 10"
Cord: 10' Brown with Snap-On Plug Included

Finish

 Polished Brass #61

Plug-in LED

LCLEDZ12-71

Finish: Antique Brass
Height: 7 1/2"
Extension: 5 1/2"
LED: 2700K, 90 CRI, 4.5 Watts, 360 Lumens
Switch: On Shade
Shade: 12"
Cord: Clear with Plug-In Driver



Finishes



Black #7



Antique Brass #71



Battery Operated LED

LABLED7-7

Finish: Black
Height: 7 1/4"
Extension: 5 1/4"
LED: 3000K, 80 CRI, 1 Watts, 35 Lumens
Switch: In Shade
Shade: 7"
Batteries: 4 AA (Not Included), illuminates 36-48 hours

Mantel Light

Finishes



Antique Brass (AB)



Polished Brass (B)



Mahogany Bronze (MB)



MA14-B

Height: 4 1/2"
Base: 15" x 3"
Bulbs: Two 25 or 40T10F
Switch: In-line, 15" from base
Shade: 14"
Cord: 10' Brown, exits back of shade



Cabinet Light

10' Brown cord with snap on plug. Cord exits back.

AC7-61



Finishes

-  Polished Brass #61
-  Antique Brass #71

Bed Light



BL10-AB

- Finish: Antique Brass
- Height: Gooseneck Adjusts from 0" to 8½"
- Base: Adjustable clip Up to 2½" Wide
- Bulb: One 40T10
- Switch: On Shade
- Shade: 10"
- Cord: 10' Brown

Portable Spot Lights

Finishes

-  Satin Nickel #52
-  White #9
-  Black #7



SP-520-9

- Height: 6"
- Cord: 10' White
- Switch: 18" from Shade
- Bulbs: 40R14N (included)



SP-510-52

- Height: 6½"
- Cord: 10' Black
- Switch: 18" from Shade
- Bulbs: 40R14N (included)

Clip-on Light

Ideal for use with laptop computers, easels, music stands and home office spaces.

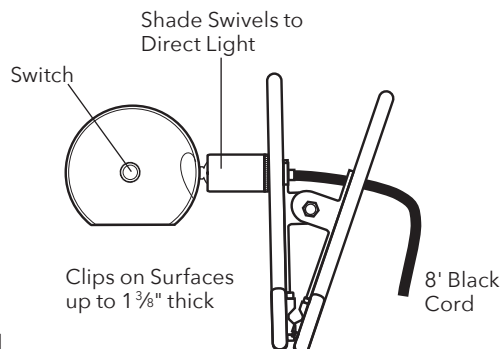

Bulb: 25T10 Included

Finish

-  Black #7

ACL7-7



Scatchard Stoneware



George Scatchard came to Vermont in 1960 to set up his first pottery as the back to the land movement in Vermont took hold. This artisan potter taught ceramics at the University of Vermont while continuing to create pottery in his own rural studio.

Scatchard design patterns are created from original hand thrown pieces then slip cast in a mold to improve consistency in shape and size.

Each piece is trimmed, glazed and signed by the potter, then fired at 2300° for 24 hours to create a beautiful and lasting surface.

Casting and Trimming, Glazing and Firing



Scatchard Stoneware Glazes

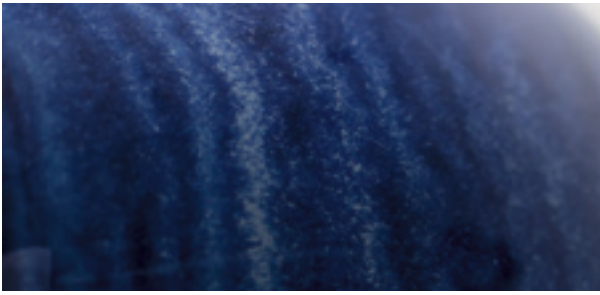

BG Blue Gloss



BM Black Matte

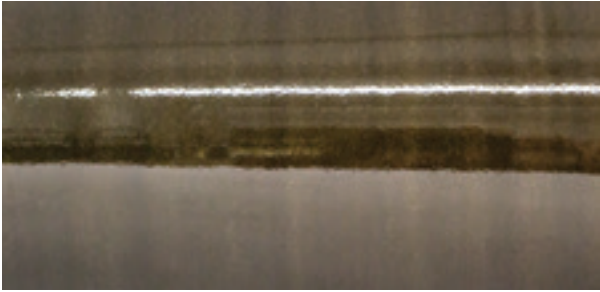

BR Brown Gloss



CB Cornflower Blue



CG Celadon

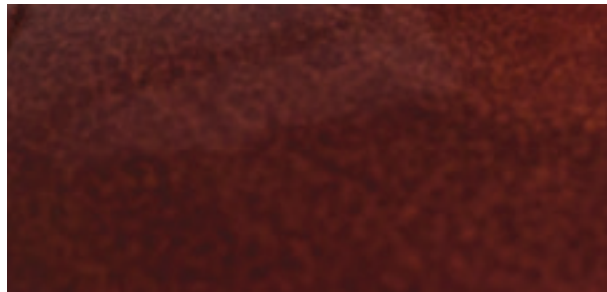

CR Copper Red



DCG Decorated Celadon



DG Decorated Gray

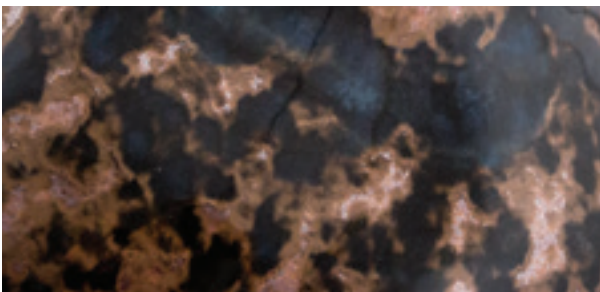

DR Decorated Red

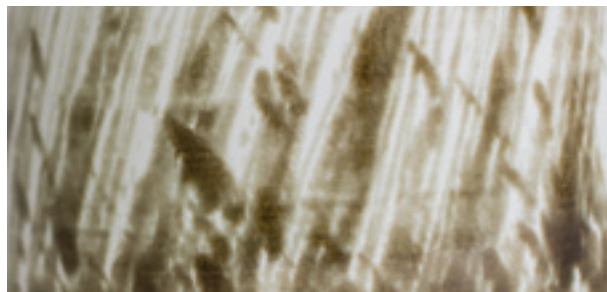

DWG Decorated White Gloss

Scatchard Stoneware Glazes

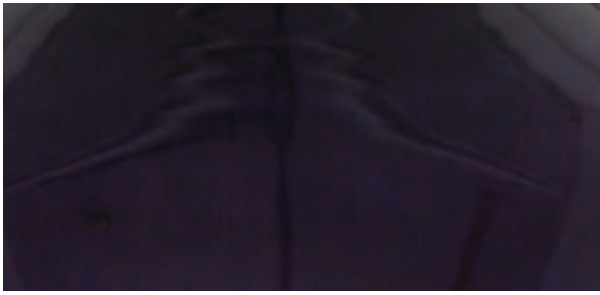

EG Eggplant



GG Gray Gloss

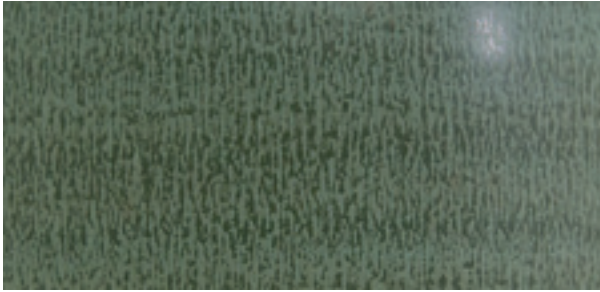

GM Green Matt

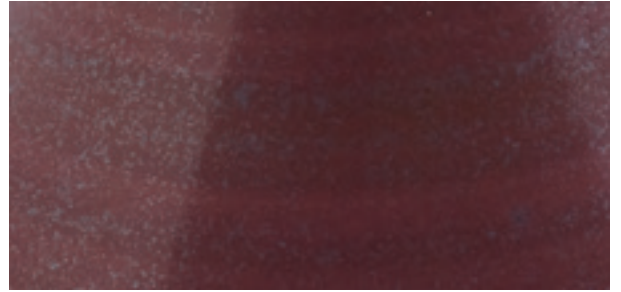

IR Iron Red



KS Kaleidoscope



MB Midnight Blue



OT Oatmeal



TE Tiger's Eye

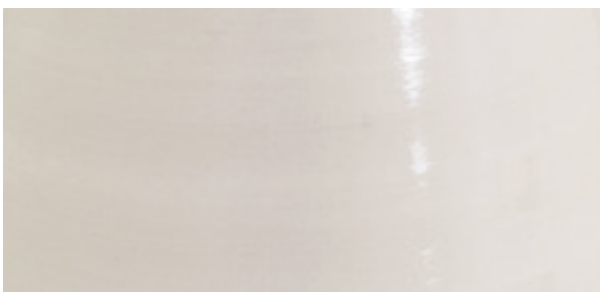

WG White Gloss



WM White Matte

Scatchard Stoneware



GS50-GG (Gray Gloss) shown

TABLE LAMPS

Available stoneware glazes shown on pages 348-349

Height: 13½"
Base: 3"
Bulb: 75W Type A
Switch: On Socket
Shade: Off White Linen Hardback
6" x 8" x 7"
Cord: 10' Clear

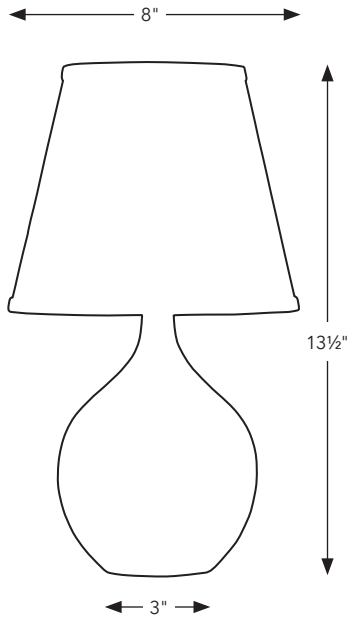

GS50-EG
Glaze Shown: Eggplant

Scatchard Stoneware

Available stoneware glazes shown on pages 348-349

Height: 25"
Base: 4¼"
Bulb: 150W 3-Way
Switch: On Socket
Shade: Cream Linen Hardback
5" x 17" x 12"
Cord: 10' Clear

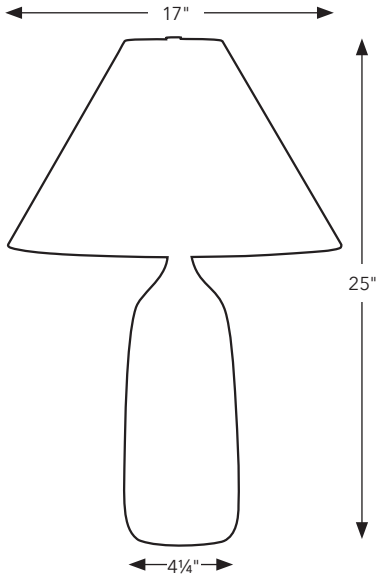

GS100-BR
Glaze Shown: Brown Gloss

TABLE LAMPS

Available stoneware glazes shown on pages 348-349

Height: 29"
Base: 6"
Bulb: 150W 3-way
Switch: On Socket
Shade: Off-white Linen Hardback
13" x 15" x 11"
Cord: 10' Silver

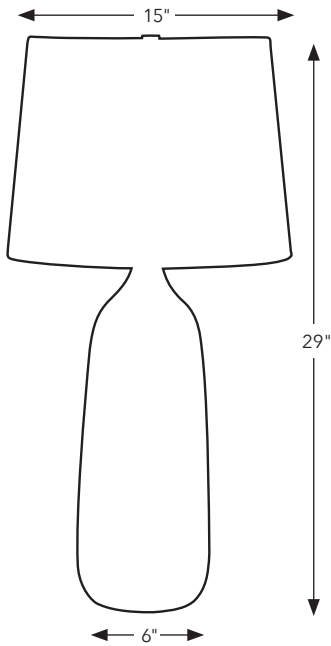

GS101-DCG

Glaze Shown: Decorated Celadon Gloss

Scatchard Stoneware



Savannah Brown Photography on location at Field Guide, Stowe VT

GS120-BM (Black Matte) shown

TABLE LAMPS

Available stoneware glazes shown on pages 348-349

Height: 19½"
Base: 8"
Bulb: 100W Type A
Switch: In-Line on Cord
Shade: Off White Linen Hardback
9" × 9" × 10"
Cord: 10' Clear

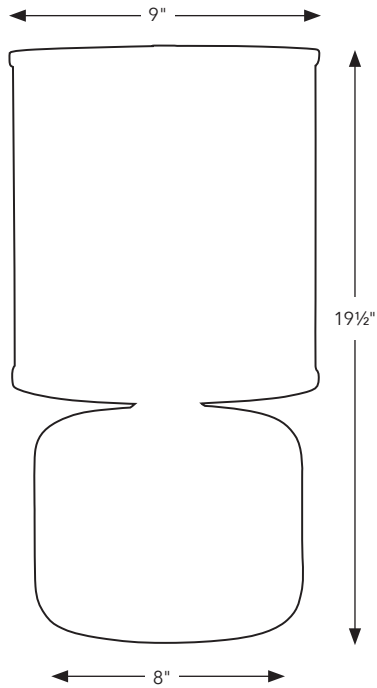

GS120-CR
Glaze Shown: Copper Red

Scatchard Stoneware

Available stoneware glazes shown on pages 348-349

Height: 22"
Base: 4¼"
Bulb: 150W 3-Way
Switch: On Socket
Shade: Cream Linen Hardback
5" x 17" x 12"
Cord: 10' Clear

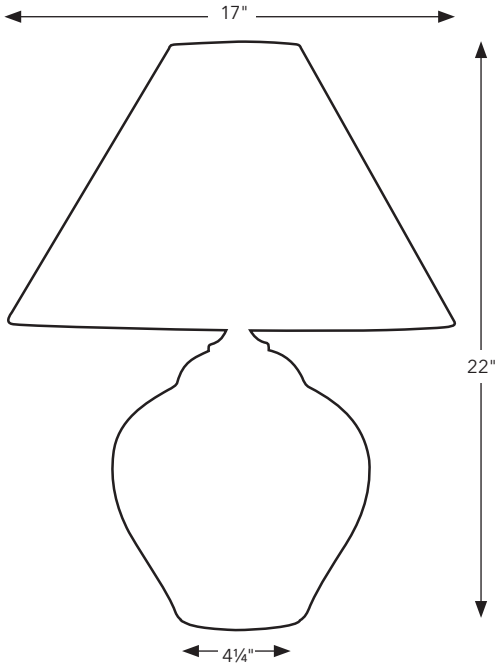

GS130-OT
Glaze Shown: Oatmeal

TABLE LAMPS



GS140-CG (Celadon Gloss) shown

Scatchard Stoneware

Available stoneware glazes shown on pages 348-349

Height: 22½"
Base: 4½"
Bulb: 150W 3-Way
Switch: On Socket
Shade: Cream Linen Hardback
5" × 17" × 12"
Cord: 10' Clear

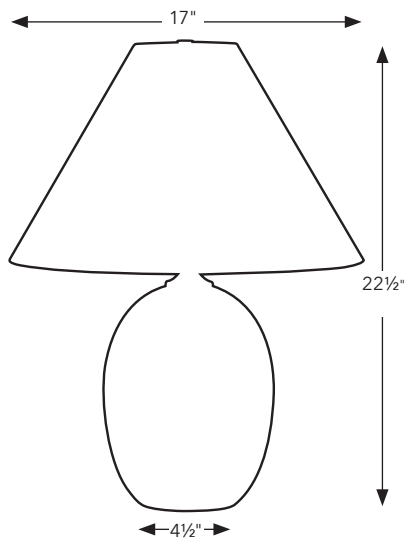

GS140-GM
Glaze Shown: Green Matte

TABLE LAMPS

Available stoneware glazes shown on pages 348-349

Height: 28½"
Base: 5¼"
Bulb: 250W 3-Way
Switch: On Socket
Shade: Cream Linen Hardback
6" x 22" x 14"
Cord: 10' Clear

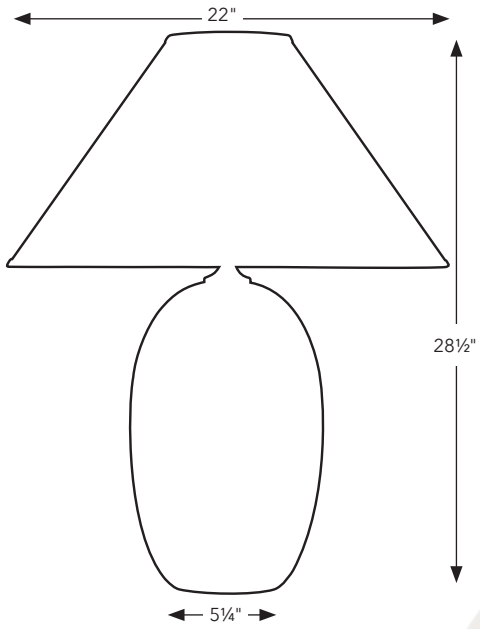

GS150-DWG
Glaze Shown: Decorated White Gloss

Scatchard Stoneware

Available stoneware glazes shown on pages 348-349

Height: 25"
Base: 5"
Bulb: 150W 3-way
Switch: On Socket
Shade: Off White Linen Softback
14" x 15" x 10"
Cord: 10" Clear

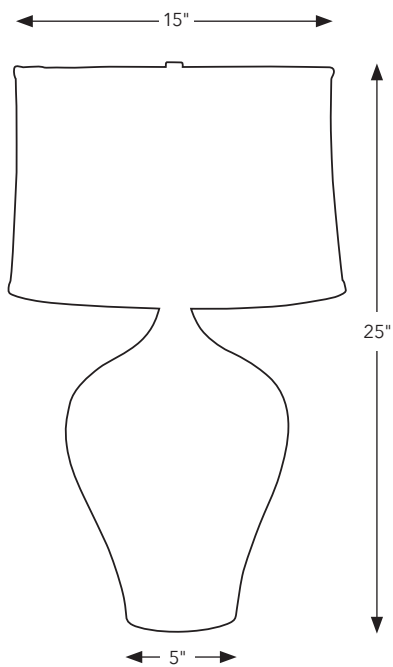

GS160-CB
Glaze Shown: Cornflower Blue

TABLE LAMPS

Available stoneware glazes shown on pages 348-349

Height: 27"
Base: 4"
Bulb: 150W 3-way
Switch: On Socket
Shade: Off White Linen Hardback
13" x 15" x 11"
Cord: 10' Silver

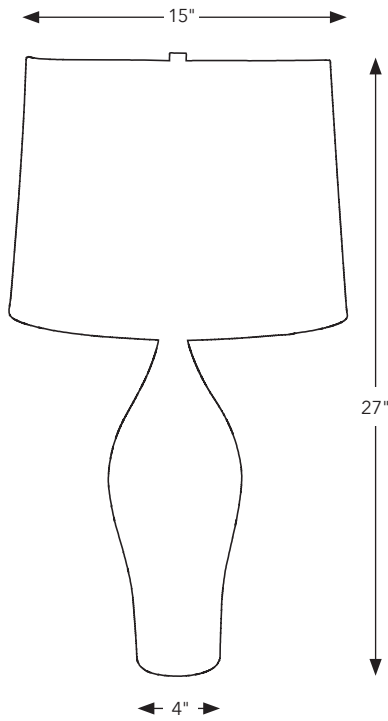

GS170-CR
Glaze Shown: Copper Red

Scatchard Stoneware

Available stoneware glazes shown on pages 348-349

Height: 22½"
Base: 3¾"
Bulb: 100W 3-Way
Switch: On Socket
Shade: Off-white Linen Hardback
9" × 10" × 9½"
Cord: 10' Clear

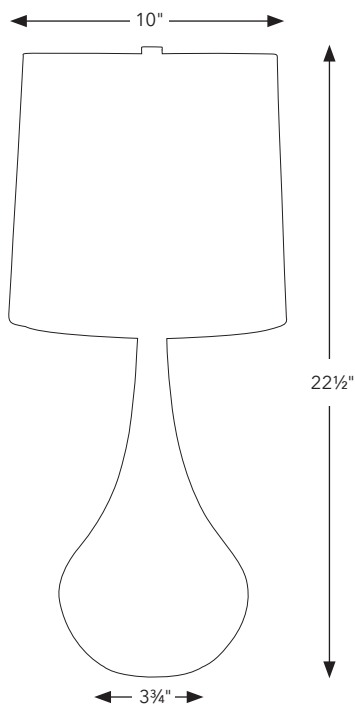

GS180-DR
Glaze Shown: Celadon

TABLE LAMPS

Available stoneware glazes shown on pages 348-349

Height: 27"
Base: 5"
Bulb: 150W 3-Way
Switch: On Socket
Shade: Cream Linen Hardback
5" x 21" x 19"
Cord: 10' Clear

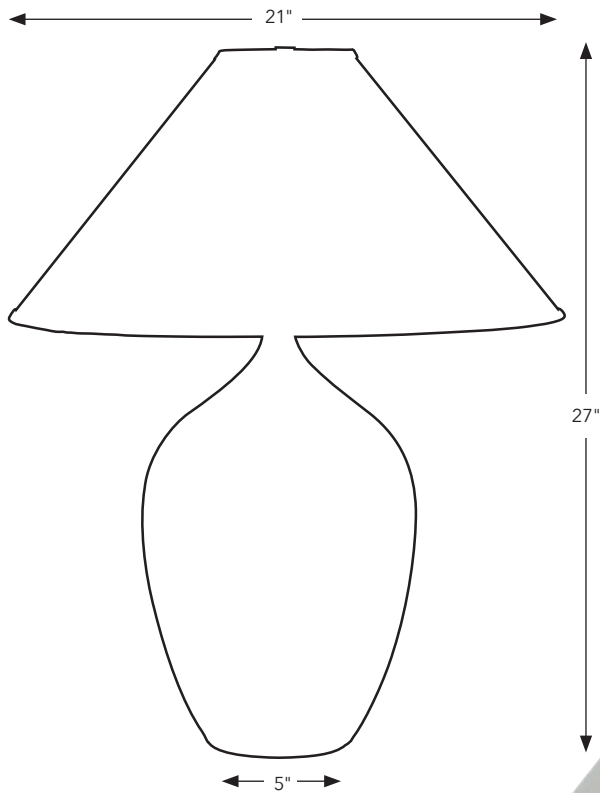

GS190-DR
Glaze Shown: Decorated Red Gloss

Scatchard Stoneware



Savannah Brown Photography on location at Field Guide, Stowe VT

GS200-WM (White Matte) shown

TABLE LAMPS

Available stoneware glazes shown on pages 348-349

Height: 19"
Base: 3¼"
Bulb: 100W 3-Way
Switch: On Socket
Shade: Cream Linen Hardback
5" × 13" × 10"
Cord: 10' Clear

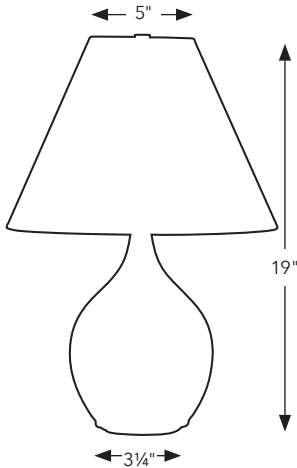

GS200-TE

Glaze Shown: Tiger's Eye

Scatchard Stoneware

Available stoneware glazes shown on pages 348-349

Height: 20½"
Base: 3¼"
Bulb: 100W 3-Way
Switch: On Socket
Shade: White Linen Hardback
9" x 9" x 10"
Cord: 10' Clear

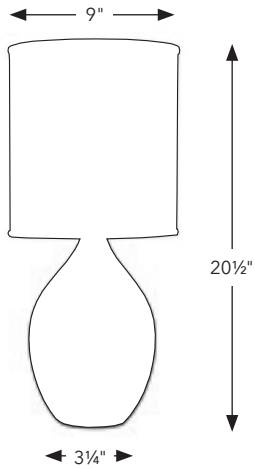

GS201-BG
Glaze Shown: Blue Gloss

TABLE LAMPS



Scatchard Stoneware

Available stoneware glazes shown on pages 348-349

Height: 18½"
Base: 3¼"
Bulb: 100W 3-Way
Switch: On Socket
Shade: White Linen Hardback
9" × 11" × 8"
Cord: 10' Clear

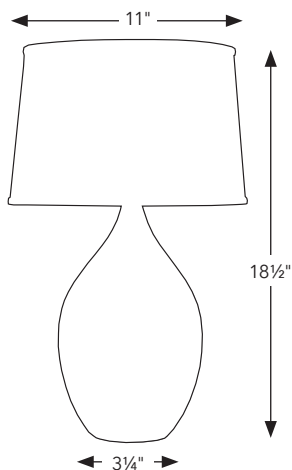

GS202-CR
Glaze Shown: Copper Red

TABLE LAMPS

Available stoneware glazes shown on pages 348-349

Height: 23½"
Base: 4¼"
Bulb: 100W 3-Way
Switch: On Socket
Shade: Cream Linen Hardback
5" × 17" × 12"
Cord: 10' Clear

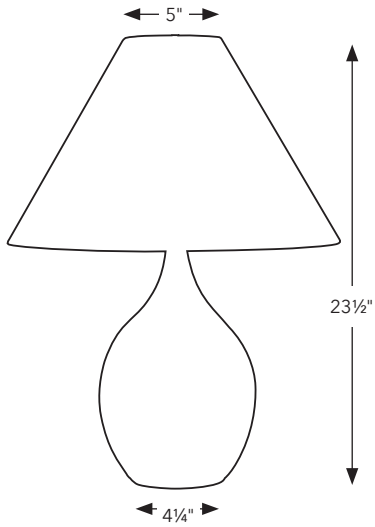

GS300-MID

Glaze Shown: Midnight Blue

Scatchard Stoneware

Available stoneware glazes shown on pages 348-349

Height: 23½"
Base: 4¼"
Bulb: 150W 3-Way
Switch: On Socket
Shade: White Linen Hardback
11" × 11" × 12"
Cord: 10' Clear

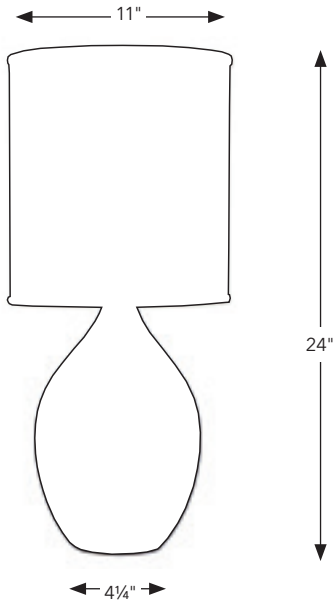

GS301-DG
Glaze Shown: Decorated Gray

TABLE LAMPS

Available stoneware glazes shown on pages 348-349

Height: 21"
Base: 4¼"
Bulb: 150W 3-Way
Switch: On Socket
Shade: White Linen Hardback 12" x 14" x 9"
Cord: 10' Clear

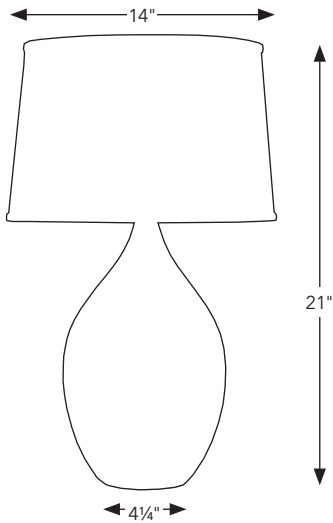

GS302-BM
Glaze Shown: Black Matte

Scatchard Stoneware

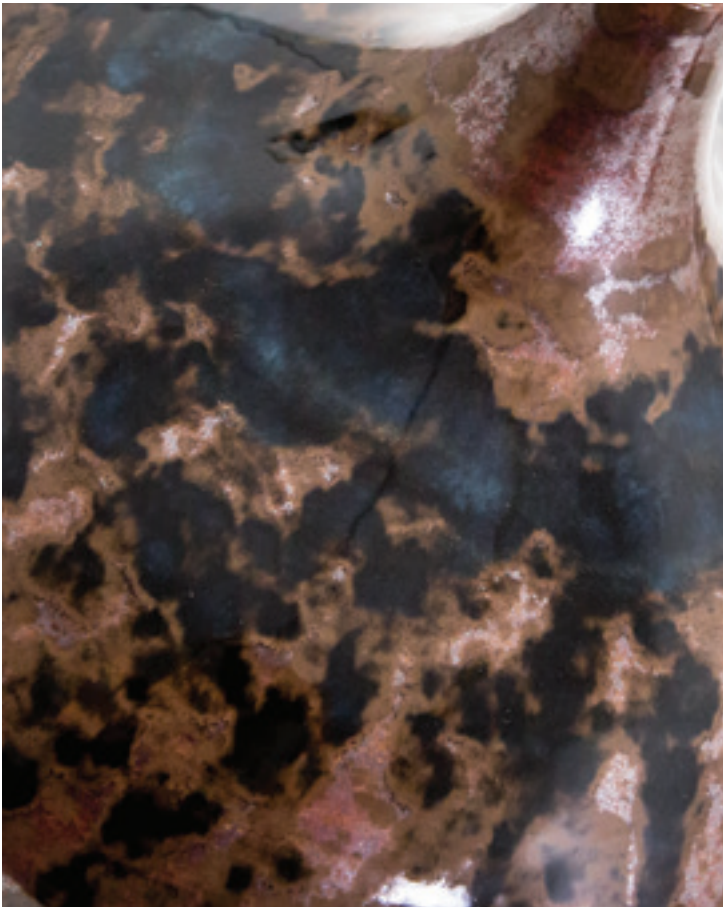
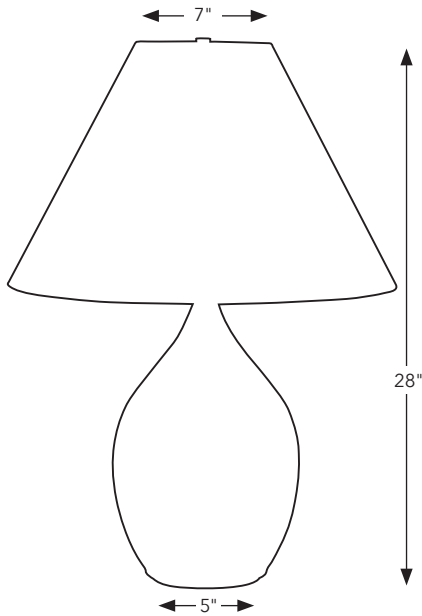

TABLE LAMPS

Available stoneware glazes shown on pages 348-349

Height: 28"
Base: 5"
Bulb: 250W 3-Way
Switch: On Socket
Shade: Cream Linen Hardback
7" x 20" x 14"
Cord: 10' Clear



GS400-CG
Glaze Shown: Celadon

Scatchard Stoneware

Available stoneware glazes shown on pages 348-349

Height: 30"
Base: 5"
Bulb: 200W 3-Way
Switch: On Socket
Shade: White Linen Hardback
13" x 13" x 14"
Cord: 10' Clear

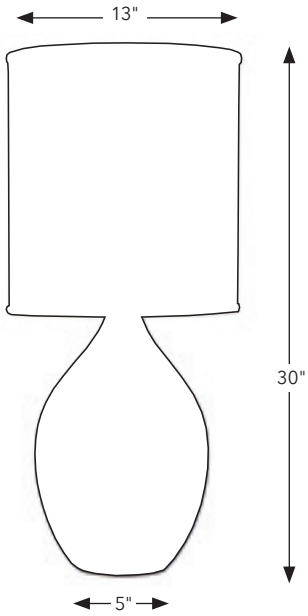

GS401-GG
Glaze Shown: Gray Gloss

TABLE LAMPS



Savannah Brown Photography on location at Field Guide, Stowe VT

GS402-CR (Copper Red) shown

Scatchard Stoneware

Available stoneware glazes shown on pages 348-349

Height: 24½"
Base: 5"
Bulb: 200W 3-Way
Switch: On Socket
Shade: White Linen Hardback
14" × 16" × 10"
Cord: 10' Clear

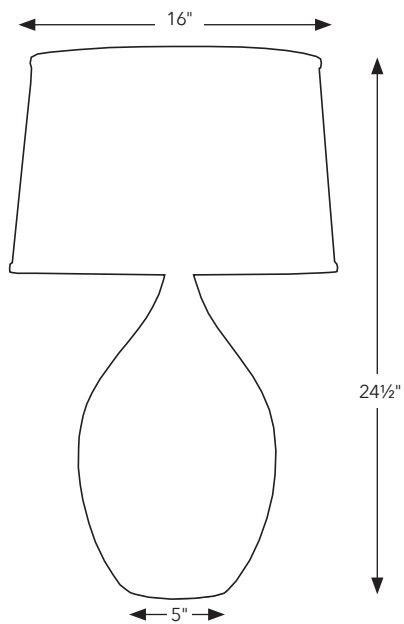

GS402-WM
Glaze Shown: White Matte

TABLE LAMPS

Available stoneware glazes shown on pages 348-349

Height: 17"
Base: 3½"
Bulb: 100W Type A
Switch: On Socket
Shade: White Linen Hardback
10" × 12" × 8"
Cord: 10' Clear

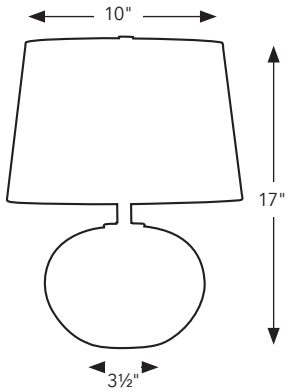

GS600-BM

Glaze Shown: Black Matte

Scatchard Stoneware



Savannah Brown Photography on location at Field Guide, Stowe VT

GS700-BM (Black Matte) shown

TABLE LAMPS

Available stoneware glazes shown on pages 348-349

Height: 22"
Base: 5"
Bulb: 150W 3-Way
Switch: On Socket
Shade: White Linen Hardback
11" x 15" x 10"
Cord: 10' Clear

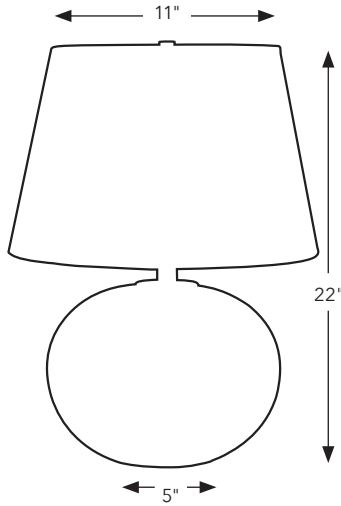

GS700-BG
Glaze Shown: Blue Gloss

Scatchard Stoneware

Available stoneware glazes shown on pages 348-349

Height: 23"
Base: 7"
Bulb: 100W 3-Way
Switch: On Socket
Shade: Off-white Linen Hardback
5" x 15" x 11"
Cord: 10' Clear

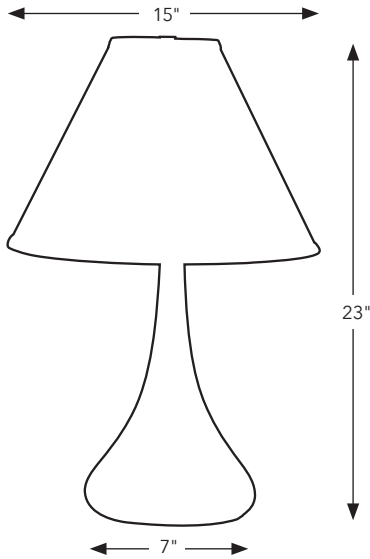

GS800-BM
Glaze Shown: Black Matte

TABLE LAMPS

Available stoneware glazes shown on pages 348-349

Height: 28"
Base: 8½"
Bulb: 100W 3-way
Switch: On Socket
Shade: Cream Linen Hardback
5" × 17" × 12"
Cord: 10' Clear

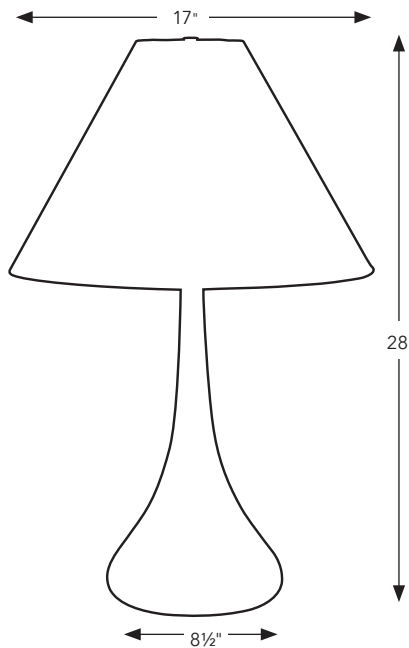

GS801-IR

Glaze Shown: Iron Red

Scatchard Stoneware



TABLE LAMPS

Available stoneware glazes shown on pages 348-349

Height: 19"
Base: 6½"
Bulb: 100W Type A
Switch: On Socket
Shade: Off-white Linen Hardback
5" × 12" × 9½"
Cord: 10' Clear

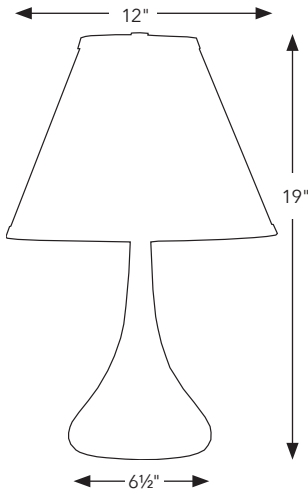

GS802-BM

Glaze Shown: Black Matte

Scatchard Stoneware



GS850-KS (Kaleidoscope) shown

TABLE LAMPS

Available stoneware glazes shown on pages 348-349

Height: 25½"
Base: 6"
Bulb: 100W 3-way
Switch: On Socket
Shade: Off-white Linen Hardback
10" × 13" × 11"
Cord: 10' Clear

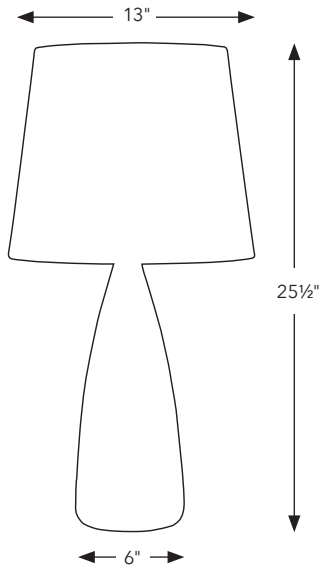

GS850-WG
Glaze Shown: White Gloss

Scatchard Stoneware Collection

Available stoneware glazes shown on pages 348-349

Height: 61"
Base: 10¾" Round
Bulb: One 250W 3-Way
Switch: On Socket
Shade: Cream Linen Hardback
15" × 17" × 12"



GS500-OBDR

Finish: Decorated Red
with Oil Rubbed Bronze
Cord: 10' Brown



GS500-SNBM

Finish: Black Matte with
Satin Nickel
Cord: 10' Clear

FLOOR/WALL LAMPS

Available stoneware glazes shown on pages 348-349

Height: 13½"
Extension: 12½"
Backplate: 6"
Bulb: 100W 3-way
Switch: On Socket
Shade: 8" x 9" x 8"
Cord: 10' Clear
30" Cord Cover Included



GS725-BG

Finish: Blue Gloss with
Satin Nickel
Shade: Cream Linen Hardback



GS725-BR

Finish: Brown Gloss with Antique Brass
Shade: Natural Linen Hardback



GS725-OT

Finish: Oatmeal with Oil
Rubbed Bronze
Shade: Natural Linen Hardback



GS725-GM

Finish: Green Matte
with Antique Brass
Shade: Cream Linen Hardback

Scatchard Stoneware Collection

Available stoneware glazes shown on pages 348-349

Height: 14½"
Extension: 7¾"
Backplate: 6"
Bulb: One 60B10
Shade: Cream Linen Hardback
4½" x 4½" x 6"

Available in Direct Wire Only



GS775-SNBG
Finish: Satin Nickel with Blue Gloss



GS775-SNGG
Finish: Satin Nickel with Gray Gloss



GS775-ABOT
Finish: Antique Brass with Oatmeal



GS775-SNBM
Finish: Satin Nickel with Black Matte

WALL LAMPS

Available stoneware glazes shown on pages 348-349

Height: 14½"
Extension: 7¾"
Backplate: 6"
Bulb: Two 60B10
Shades: Cream Linen Hardback
4½" x 4½" x 6"

Available in Direct Wire Only



GS775-2-ABOT
Finish: Antique Brass
with Oatmeal



GS775-2-SNBM
Finish: Satin Nickel
with Black Matte



GS775-2-SNBG
Finish: Satin Nickel
with Blue Gloss



GS775-2-SNGG
Finish: Satin Nickel
with Gray Gloss

Product Finishes

Please refer to this section for color representations of finish. Stocked finishes are listed on specific product pages. If you would like a finish on a Vermont made product that is not stocked, call our customer service department for lead time and cost.

Metal Finishes



Polished Brass #61



Statuary Bronze #56



Satin Brass #51



Weathered Brass #76



Antique Brass #71

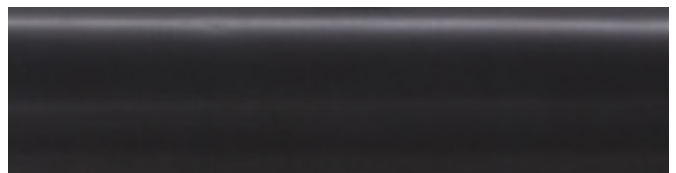

Oil Rubbed Bronze #91



Gold #1



Pewter #31



Bronze #5



Mahogany Bronze #81



Chrome #62

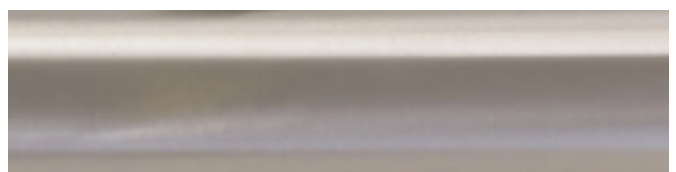

Satin Nickel #52



Polished Nickel (PN)

Product Finishes

Powder Coated Finishes



Black #7

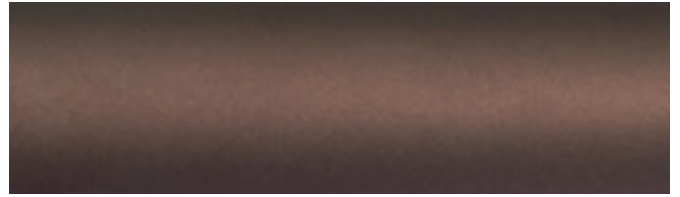

Chestnut Bronze (CHB)

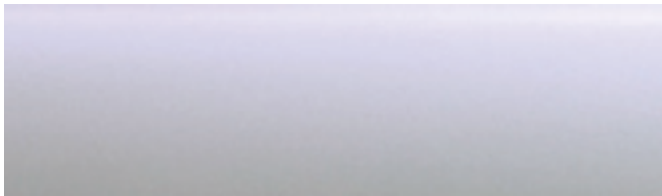

White #9



Granite (GT)

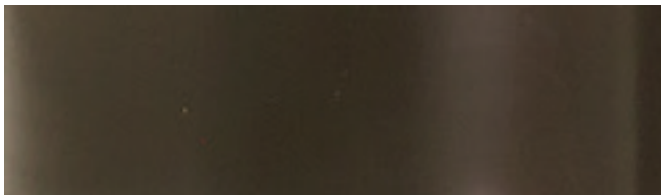

Architectural Bronze (ABZ)



Bittersweet (BS)



Navy Blue (NB)

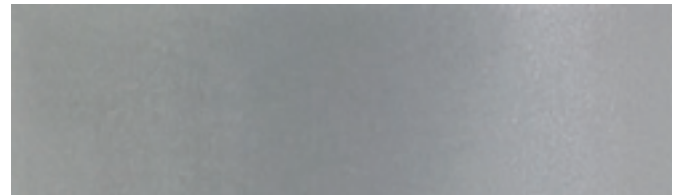

Platinum Gray (PG)



Teal (TL)



Pink (PK)

Distributed Product Finishes:

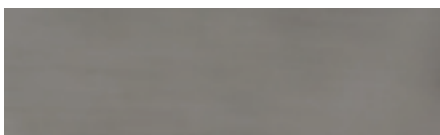

Satin Pewter (SP)

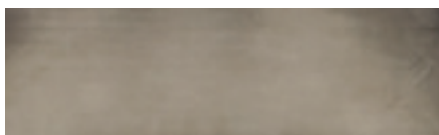

Antique Silver (AS)

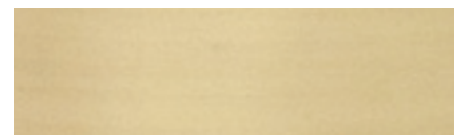

Raw Brass (RB)

Questions & Answers

The following are answers to some of the most frequently asked questions about our products which should assist with your selection process.

Q. How do you measure the extension of a swing arm?

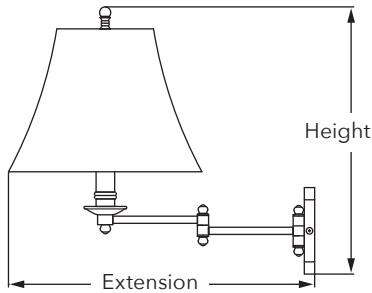

Q. How are lamp shades dimensioned in the catalog?

A. Top × Bottom × Side (slant).

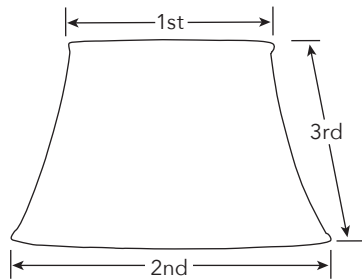

Q. How do you measure the height of a Desk/Piano Lamp?

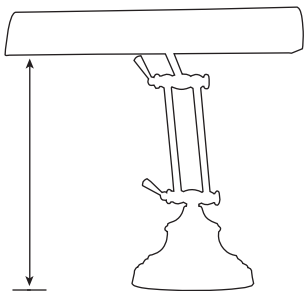

Q. What size picture light should I use?

A. Measure the width of the image and use a Classic picture light approximately one half the size, or a Slim-line picture light approximately two thirds the size of the image.

Q. Can I modify a cord length and add a polarized plug?

A. Yes. We offer a UL approved snap-on-plug that can be attached to any standard UL approved SPT-2 cord. Instructions are included with plug.

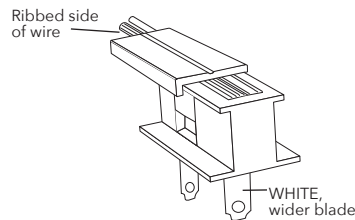

Q. Is there a way to eliminate seeing the cord?

- Install a recessed outlet (sometimes called a "clock outlet") behind the artwork.

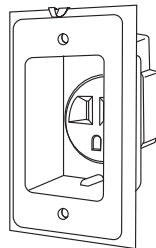

- Use a Cord Cover.
- Paint the cord to match the wall color.
- Place furniture, plants or other décor to hide cord.

Q. How do you install a picture light?

A. All House of Troy picture lights come with mounting hardware and may be attached to either the picture frame or the wall. The only tools necessary are a screw driver and something to start a screw-hole, such as a small nail or awl.

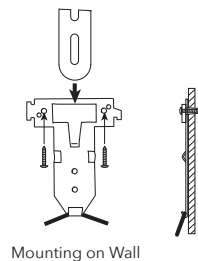
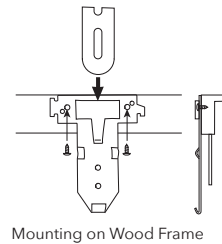

Q. How do you install a Slim-line Picture Light?

A. Snap the Picture Light arms into the Mounting Brackets. This will take a bit of force, but will not damage the arms. Slide the arms up or down to attain the desired shade location in relation to the frame.

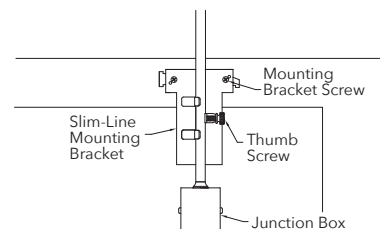

INDEX

ITEM	PAGE	ITEM	PAGE	ITEM	PAGE	ITEM	PAGE
A7-61*	29	APL25-61	27	C9-51*	23	CR700-OB	100
A7-71*	29	APL25-71	27	C9-52*	23	CR700-SN	100
A14-61*	29	APL25-91	27	C9-61*	23	CR725-AB	101 & 279
A14-71*	29	APR16-7	28	C9-62*	23	CR725-OB	101 & 279
ABLED7-61*	66	APR16-52	28	C16-1*	23	CR725-SN	101 & 279
ABLED7-71*	66	APR16-61	28	C16-51*	23	D100-AB*	107
ABLED14-61*	66	APR16-71	28	C16-52*	23	D100-OB*	107
ABLED14-71*	66	AV100-OB*	74	C16-61*	23	D100-SN*	107
AC7-61*	345	AV100-PN*	74	C16-62*	23	D150-AB*	108
AC7-71*	345	AV101-OB*	75	C24-1*	23	D150-OB*	108
ACL7-7*	345	AV101-PN*	75	C24-51*	23	D150-SN*	108
AD400-AB	71	B500-BPN	77	C24-52*	23	D175-AB*	109 & 271
AD400-OB	71	B500-BWB	77	C24-61*	23	D175-OB*	109 & 271
AD400-SN	71	B500-WB	77	C24-62*	23	D175-SN*	109 & 271
AD425-AB	72 & 263	B501-BPN	78	C300-WB/BLK*	85	D300-AB	102
AD425-OB	72 & 263	B501-BWB	78	C300-WB/WT*	85	D300-AB-G	103
AD425-SN	72 & 263	B501-WB	78	C350-WB/BLK*	86	D300-OB	102
AD450-AB	73	B502-WB	79	C350-WB/WT*	86	D300-OB-G	103
AD450-OB	73	B550-BPN	80	CBLED12-7*	330	D300-PN	102
AD450-SN	73	B550-BWB	80	CBLED12-61*	330	D300-PN-G	103
AGLED-7	26	B550-WB	80	CH800-AB	95	D350-AB	104
AGLED-51	26	B551-BPN	81	CH800-AS	95	D350-AB-G	105
AGLED-52	26	B551-BWB	81	CH800-OB	95	D350-OB	104
AGLED-71	26	B551-WB	81	CH825-AB	96	D350-OB-G	105
AP10-20-7	302	BL10-AB	345	CH825-AS	96	D350-PN	104
AP10-20-61	302	BPLED200-81*	329	CH825-OB	96	D350-PN-G	105
AP10-20-71	302	BPLED200-617*	329	CH850-AB	97	D436-52	168
AP10-21-61	303	BSLED14-51*	63	CH850-AS	97	D436-71	168
AP10-21-7	303	BSLED14-52*	63	CH850-OB	97	DC9-51*	46
AP10-21-71	303	BSLED14-71*	63	CH875-OB	98	DC9-52*	46
AP10-21-91	303	BSLED14-91*	63	CH876-AB	98	DC9-61*	46
AP10-25-7*	302	BSLED24-51*	63	CH878-AB	98	DC9-62*	46
AP14-40-7	304	BSLED24-52*	63	CH880-OB	98	DC16-51*	46
AP14-40-61	304	BSLED24-71*	63	CL200-AB	88	DC16-52*	46
AP14-40-71	304	BSLED24-91*	63	CL200-AS	88	DC16-61*	46
AP14-41-7	305	BTLED14-1*	65	CL200-OB	88	DC16-62*	46
AP14-41-61	305	BTLED14-51*	65	CL201-AB	89	DC24-51*	46
AP14-41-71	305	BTLED14-61*	65	CL201-AS	89	DC24-52*	46
AP14-41-91	306	BTLED14-71*	65	CL201-OB	89	DC24-61*	46
AP14-42-61	306	BTLED14-81*	65	CL201-PB	89	DC24-62*	46
AP14-45-7*	306	BTLED24-1*	65	CL202-AB	90	DCLEDZ12-51*	47
APL9-7	27	BTLED24-51*	65	CL202-AS	90	DCLEDZ12-52*	47
APL9-52	27	BTLED24-61*	65	CL202-OB	90	DCLEDZ12-71*	47
APL9-61	27	BTLED24-71*	65	CL225-AB	91 & 278	DCLEDZ24-51*	47
APL9-71	27	BTLED24-81*	65	CL225-AS	91 & 278	DCLEDZ24-52*	47
APL9-91	27	BU200-OB*	83	CL225-OB	91 & 278	DCLEDZ24-71*	47
APL16-7	27	BU200-PN*	83	CL250-AB	92	DGLEDZ14-AB*	55
APL16-52	27	C5-1*	23	CL250-AS	92	DGLEDZ14-OB*	55
APL16-61	27	C5-51*	23	CL250-OB	92	DGLEDZ14-PN*	55
APL16-71	27	C5-52*	23	CL251-AB	93	DGLEDZ14-SN*	55
APL16-91	27	C5-61*	23	CL251-AS	93	DGLEDZ14-WB*	55
APL25-7	27	C5-62*	23	CL251-OB	93	DGLEDZ24-AB*	55
APL25-52	27	C9-1*	23	CR700-AB	100	DGLEDZ24-OB*	55

INDEX

ITEM	PAGE	ITEM	PAGE	ITEM	PAGE	ITEM	PAGE
DGLEDZ24-PN*	55	DOX16-OB*	49	DST16-MBAB*	53	DTLEDZ14-81*	45
DGLEDZ24-SN*	55	DOX16-SN*	49	DST16-SNBLK*	53	DTLEDZ24-51*	45
DGLEDZ24-WB*	55	DOX30-AB*	49	DST30-ABMB*	53	DTLEDZ24-52*	45
DGLEDZ36-AB*	55	DOX30-OB*	49	DST30-MBAB*	53	DTLEDZ24-61*	45
DGLEDZ36-OB*	55	DOX30-SN*	49	DST30-SNBLK*	53	DTLEDZ24-71*	45
DGLEDZ36-PN*	55	DOX42-AB*	49	DST42-ABMB*	53	DTLEDZ24-81*	45
DGLEDZ36-SN*	55	DOX42-OB*	49	DST42-MBAB*	53	DTLEDZ36-51*	45
DGLEDZ36-WB*	55	DOX42-SN*	49	DST42-SNBLK*	53	DTLEDZ36-52*	45
DHA05-AB*	61	DOXLEDZ16-AB*	50	DSTLEDZ16-ABMB*	52	DTLEDZ36-61*	45
DHA05-BLK*	61	DOXLEDZ16-OB*	50	DSTLEDZ16-MBAB*	52	DTLEDZ36-71*	45
DHA05-MB*	61	DOXLEDZ16-SN*	50	DSTLEDZ16-SNBLK*	52	DTLEDZ36-81*	45
DHA05-SN*	61	DOXLEDZ30-AB*	50	DSTLEDZ30-ABMB*	52	DTRLEDZ14-AB/PB*	45
DHA05-WT*	61	DOXLEDZ30-OB*	50	DSTLEDZ30-MBAB*	52	DTRLEDZ14-BLK/PN*	45
DHA24-AB*	61	DOXLEDZ30-SN*	50	DSTLEDZ30-SNBLK*	52	DTRLEDZ14-MB/AB*	45
DHA24-BLK*	61	DOXLEDZ42-AB*	50	DSTLEDZ42-ABMB*	52	DTRLEDZ14-SN/PN*	45
DHA24-MB*	61	DOXLEDZ42-OB*	50	DSTLEDZ42-MBAB*	52	DTRLEDZ24-AB/PB*	45
DHA24-SN*	61	DOXLEDZ42-SN*	50	DSTLEDZ42-SNBLK*	52	DTRLEDZ24-BLK/PN*	45
DHA24-WT*	61	DSCLEDZ19-51*	248	DT8-51*	43	DTRLEDZ24-MB/AB*	45
DHA36-AB*	61	DSCLEDZ19-52*	248	DT8-52*	43	DTRLEDZ24-SN/PN*	45
DHA36-BLK*	61	DSCLEDZ19-61*	248	DT8-61*	43	DTRLEDZ36-AB/PB*	45
DHA36-MB*	61	DSCLEDZ19-71*	248	DT8-71*	43	DTRLEDZ36-BLK/PN*	45
DHA36-SN*	61	DSCLEDZ19-91*	248	DT8-81*	43	DTRLEDZ36-MB/AB*	45
DHA36-WT*	61	DSK428-G61*	307	DT14-51*	43	DTRLEDZ36-SN/PN*	45
DHLEDZ12-51*	39	DSK428-G71*	307	DT14-52*	43	DTSLEDZ14-AB/PB*	45
DHLEDZ12-52*	39	DSK430-MB*	307	DT14-61*	43	DTSLEDZ14-BLK/PN*	45
DHLEDZ12-62*	39	DSK440-ABMB*	308	DT14-71*	43	DTSLEDZ14-MB/AB*	45
DHLEDZ12-71*	39	DSK440-MBAC*	308	DT14-81*	43	DTSLEDZ14-SN/PN*	45
DHLEDZ12-91*	39	DSK440-SNBLK*	308	DT24-51*	43	DTSLEDZ24-AB/PB*	45
DHLEDZ26-51*	39	DSL14-51*	33	DT24-52*	43	DTSLEDZ24-BLK/PN*	45
DHLEDZ26-52*	39	DSL14-52*	33	DT24-61*	43	DTSLEDZ24-MB/AB*	45
DHLEDZ26-62*	39	DSL14-71*	33	DT24-71*	43	DTSLEDZ24-SN/PN*	45
DHLEDZ26-71*	39	DSL14-91*	33	DT24-81*	43	DTSLEDZ36-AB/PB*	45
DHLEDZ26-91*	39	DSL24-51*	33	DT36-51*	43	DTSLEDZ36-BLK/PN*	45
DL10-OB*	57	DSL24-52*	33	DT36-52*	43	DTSLEDZ36-MB/AB*	45
DL10-WB*	57	DSL24-71*	33	DT36-61*	43	DTSLEDZ36-SN/PN*	45
DL20-OB*	285	DSL24-91*	33	DT36-71*	43	DXL14-51*	34
DL20-WB*	285	DSL36-51*	33	DT36-81*	43	DXL14-52*	34
DMLEDZ15-51*	37	DSL36-52*	33	DTBLEDZ14-AB/PB*	45	DXL14-61*	34
DMLEDZ15-52*	37	DSL36-71*	33	DTBLEDZ14-BLK/PN*	45	DXL14-62*	34
DMLEDZ15-62*	37	DSL36-91*	33	DTBLEDZ14-MB/AB*	45	DXL14-71*	34
DMLEDZ15-71*	37	DSLEDZ14-51*	35	DTBLEDZ14-SN/PN*	45	DXL14-91*	34
DMLEDZ15-91*	37	DSLEDZ14-52*	35	DTBLEDZ24-AB/PB*	45	DXL24-51*	34
DMLEDZ29-51*	37	DSLEDZ14-71*	35	DTBLEDZ24-BLK/PN*	45	DXL24-52*	34
DMLEDZ29-52*	37	DSLEDZ14-91*	35	DTBLEDZ24-MB/AB*	45	DXL24-61*	34
DMLEDZ29-62*	37	DSLEDZ28-51*	35	DTBLEDZ24-SN/PN*	45	DXL24-62*	34
DMLEDZ29-71*	37	DSLEDZ28-52*	35	DTBLEDZ36-AB/PB*	45	DXL24-71*	34
DMLEDZ29-91*	37	DSLEDZ28-71*	35	DTBLEDZ36-BLK/PN*	45	DXL24-91*	34
DMLEDZ43-51*	37	DSLEDZ28-91*	35	DTBLEDZ36-MB/AB*	45	DXL36-51*	34
DMLEDZ43-52*	37	DSLEDZ43-51*	35	DTBLEDZ36-SN/PN*	45	DXL36-52*	34
DMLEDZ43-62*	37	DSLEDZ43-52*	35	DTLEDZ14-51*	45	DXL36-61*	34
DMLEDZ43-71*	37	DSLEDZ43-71*	35	DTLEDZ14-52*	45	DXL36-62*	34
DMLEDZ43-91*	37	DSLEDZ43-91*	35	DTLEDZ14-61*	45	DXL36-71*	34
DOX16-AB*	49	DST16-ABMB*	53	DTLEDZ14-71*	45	DXL36-91*	34

INDEX

ITEM	PAGE	ITEM	PAGE	ITEM	PAGE	ITEM	PAGE
DZLEDZ12-51*	41	G200-CHB*	128	GEO210*	148	GS101-WM*	353
DZLEDZ12-52*	41	G200-GT*	128	GEO211*	149	GS120-BG*	355
DZLEDZ12-62*	41	G250-CHB*	129	GEO306*	146	GS120-BM*	355
DZLEDZ12-71*	41	G250-GT*	129	GEO309*	147	GS120-CG*	355
DZLEDZ12-91*	41	G300-BLK*	131	GEO310*	148	GS120-CR*	355
DZLEDZ24-51*	41	G300-CHB*	131	GEO311*	149	GS120-GG*	355
DZLEDZ24-52*	41	G300-GT*	131	GEO406*	146	GS120-WM*	355
DZLEDZ24-62*	41	G300-WT*	131	GEO409*	147	GS130-CG*	356
DZLEDZ24-71*	41	G350-BLK*	132 & 338	GEO410*	148	GS130-IR*	356
DZLEDZ24-91*	41	G350-CHB*	132 & 338	GEO411*	149	GS130-OT*	356
DZLEDZ36-51*	41	G350-GT*	132 & 338	GP10-7*	331	GS140-BM*	358
DZLEDZ36-52*	41	G350-WT*	132 & 338	GP10-61*	331	GS140-DCG*	358
DZLEDZ36-62*	41	G375-BLK*	133 & 272	GP10-81*	331	GS140-DWG*	358
DZLEDZ36-71*	41	G375-CHB*	133 & 272	GP14-7*	332	GS140-GM*	358
DZLEDZ36-91*	41	G375-GT*	133 & 272	GP14-61*	332	GS140-OT*	358
E900-AB	111	G375-WT*	133 & 272	GP14-81*	332	GS140-WM*	358
E900-OB	111	G400-ABZ*	135	GPH10-BLK*	333	GS150-BM*	359
E900-SN	111	G400-BLK*	135	GPH10-PB*	333	GS150-DCG*	359
E901-AB	112	G400-BS*	135	GPLED19-7*	334	GS150-DWG*	359
E901-OB	112	G400-GT*	135	GPLED19-61*	334	GS150-GM*	359
E901-SN	112	G400-NB*	136	GPLED19-527*	334	GS150-OT*	359
E902-AB	113	G400-PG*	136	GPLED26-7*	336	GS150-WM*	359
E902-OB	113	G400-WT*	136	GPXL22-61*	337	GS160-BR*	360
E902-SN	113	G450-ABZ*	137	GPXL-617*	337	GS160-CB*	360
E903-AB	114	G450-BLK*	137	GPXL-627*	337	GS160-CG*	360
E903-OB	114	G450-BS*	137	GPZLEDZ12-7*	335	GS160-CR*	360
E903-SN	114	G450-GT*	137	GPZLEDZ12-61*	335	GS160-DR*	360
E904-AB	115	G450-NB*	138	GPZLEDZ24-7*	336	GS160-EG*	360
E904-OB	115	G450-PG*	138	GPZLEDZ24-61*	336	GS160-WG*	360
E904-SN	115	G450-WT*	138	GR900-AB	249	GS170-BG*	361
E951-AB	116	G475-ABZ*	140 & 273	GR900-OB	249	GS170-CG*	361
E951-OB	116	G475-BLK*	139 & 274	GR901-AB	250	GS170-CR*	361
E951-SN	116	G475-GT*	139 & 273	GR901-OB	250	GS170-GG*	361
F100-AB	118	G475-PG*	140 & 273	GS50-BG*	351	GS180-BG*	362
F100-OB	118	G475-WT*	139 & 274	GS50-BM*	351	GS180-BM*	362
F100-PN	118	G500-ABZ*	142	GS50-CB*	351	GS180-CG*	362
FL10-MB*	343	G500-BLK*	142	GS50-CG*	351	GS180-CR*	362
FR700-OB	120	G500-PG*	142	GS50-CR*	351	GS180-GG*	362
FR700-PN	120	G500-WT*	142	GS50-EG*	351	GS180-WM*	362
FR701-OB	121	G550-ABZ*	143	GS50-EG*	351	GS190-BG*	363
FR701-PN	121	G550-BLK*	143	GS50-GG*	351	GS190-DR*	363
FR750-OB	122	G550-PG*	143	GS50-TE*	351	GS190-GM*	363
FR750-PN	122	G550-WT*	143	GS50-WM*	351	GS200-BG*	365
FRSW*	25	G575-ABZ*	144 & 275	GS100-BM*	352	GS200-BM*	365
G100-CHB*	124	G575-BLK*	144 & 275	GS100-BR*	352	GS200-CG*	365
G100-GT*	124	G575-PG*	144 & 275	GS100-DCG*	352	GS200-CR*	365
G100-WT*	124	G575-WT*	144 & 275	GS100-DWG*	352	GS200-OT*	365
G150-CHB*	125	GEO106*	146	GS100-OT*	352	GS200-DG*	365
G150-GT*	125	GEO109*	147	GS100-WM*	352	GS200-DR*	365
G150-WT*	125	GEO110*	148	GS101-BM*	352	GS200-GG*	365
G175-CHB*	126 & 269	GEO111*	149	GS101-BR*	353	GS200-MID*	365
G175-GT*	126 & 269	GEO206*	146	GS101-DCG*	353	GS200-TE*	365
G175-WT*	126 & 269	GEO209*	147	GS101-DWG*	353	GS200-WM*	365
				GS101-OT*	353	GS201-BG*	366

INDEX

ITEM	PAGE	ITEM	PAGE	ITEM	PAGE	ITEM	PAGE
GS201-BM*	366	GS400-DG*	373	GS801-WM*	381	283	
GS201-CG*	366	GS400-DR*	373	GS802-BG*	383	HP725-OB-WL*	175 & 283
GS201-CR*	366	GS400-GG*	373	GS802-BM*	383	HP725-WB-BP*	176 & 284
GS201-DG*	366	GS400-MID*	373	GS802-GG*	383	HP725-WB-MSWB*	176 & 284
GS201-DR*	366	GS400-TE*	373	GS802-WM*	383		
GS201-GG*	366	GS400-WM*	373	GS850-DCG*	385	HP725-WB-WL*	176 & 284
GS201-MID*	366	GS401-BG*	374	GS850-DWG*	385	HP750-OB-BP*	177
GS201-TE*	366	GS401-BM*	374	GS850-KS*	385	HP750-OB-MSOB*	177
GS201-WM*	366	GS401-CG*	374	GS850-WG*	385	HP750-OB-WL*	177
GS202-BG*	368	GS401-CR*	374	H500-AB	151	HP750-WB-BP*	178
GS202-BM*	368	GS401-DG*	374	H500-SN	151	HP750-WB-MSWB*	178
GS202-CG*	368	GS401-DR*	374	H503-AB	152	HP750-WB-WL*	178
GS202-CR*	368	GS401-GG*	374	H503-SN	152	IR700-AB*	179
GS202-DG*	368	GS401-MID*	374	H550-AB	153	IR700-OB*	179
GS202-DR*	368	GS401-TE*	374	H550-SN	153	IR700-PN*	179
GS202-GG*	368	GS401-WM*	374	H553-AB	154	IR701-AB*	180
GS202-MID*	368	GS402-BG*	376	H553-SN	154	IR701-OB*	180
GS202-TE*	368	GS402-BM*	376	HLEDZ12-51*	15	IR701-PN*	180
GS202-WM*	368	GS402-CG*	376	HLEDZ12-52*	15	IR703-AB*	181
GS300-BG*	369	GS402-CR*	376	HLEDZ12-62*	15	IR703-OB*	181
GS300-BM*	369	GS402-DG*	376	HLEDZ12-71*	15	IR703-PN*	181
GS300-CG*	369	GS402-DR*	376	HLEDZ12-91*	15	IR751-AB*	182
GS300-CR*	369	GS402-GG*	376	HLEDZ26-51*	15	IR751-OB*	182
GS300-DG*	369	GS402-MID*	376	HLEDZ26-52*	15	IR751-PN*	182
GS300-DR*	369	GS402-TE*	376	HLEDZ26-62*	15	JLED500-BLK*	183
GS300-GG*	369	GS402-WM*	376	HLEDZ26-71*	15	JLED500-CHB*	183
GS300-MID*	369	GS500-OBDR*	386	HLEDZ26-91*	15	JLED500-GT*	183
GS300-TE*	369	GS500-SNBM*	386	HLEDZ600-ABZ*	170	JLED550-BLK*	184
GS300-WM*	369	GS600-BG*	377	HLEDZ600-GT*	170	JLED550-CHB*	184
GS301-BG*	370	GS600-BM*	377	HLEDZ600-PG*	170	JLED550-GT*	184
GS301-BM*	370	GS600-GG*	377	HLEDZ650-ABZ*	171	K100-BLK*	186
GS301-CG*	370	GS600-WM*	377	HLEDZ650-GT*	171	K100-GR*	186
GS301-CR*	370	GS700-BG*	379	HLEDZ650-PG*	171	K100-WT*	186
GS301-DG*	370	GS700-BM*	379	HP8-61*	24	K130-BLK*	187
GS301-DR*	370	GS700-GG*	379	HP8-71*	24	K130-GR*	187
GS301-GG*	370	GS700-WM*	379	HP8-76*	24	K130-WT*	187
GS301-MID*	370	GS725-BG*	387	HP8-91*	24	K150-BLK*	188
GS301-TE*	370	GS725-BR*	387	HP16-61*	24	K150-GR*	188
GS301-WM*	370	GS725-GM*	387	HP16-71*	24	K150-PK*	189
GS302-BG*	371	GS725-OT*	387	HP16-76*	24	K150-TL*	188
GS302-BM*	371	GS775-ABOT*	388	HP16-91*	24	K150-WT*	189
GS302-CG*	371	GS775-SNBG*	388	HP30-61*	24	K175-BLK*	190 & 277
GS302-CR*	371	GS775-SNBM*	388	HP30-71*	24	K175-GR*	190 & 277
GS302-DG*	371	GS775-SNGG*	388	HP30-76*	24	K175-WT*	190 & 277
GS302-DR*	371	GS775-2-ABOT*	389	HP30-91*	24	L10-61*	344
GS302-GG*	371	GS775-2-SNBG*	389	HP700-OB-BP*	173	L800-AB	192
GS302-MID*	371	GS775-2-SNBM*	389	HP700-OB-MSOB*	173	L800-OB	192
GS302-TE*	371	GS775-2-SNGG*	389	HP700-OB-WL*	173	L800-SN	192
GS302-WM*	371	GS800-BM*	380	HP700-WB-BP*	174	L850-AB	193
GS400-BG*	373	GS800-IR*	380	HP700-WB-MSWB*	174	L850-OB	193
GS400-BM*	373	GS800-WM*	380	HP700-WB-WL*	174	L850-SN	193
GS400-CG*	373	GS801-BM*	381	HP725-OB-BP*	175 & 283	LABLED7-7*	344
GS400-CR*	373	GS801-IR*	381	HP725-OB-MSOB*	175 &	LABLED7-71*	344

INDEX

ITEM	PAGE	ITEM	PAGE	ITEM	PAGE	ITEM	PAGE
LCLEDZ12-7*	344	N606-AB	210	P10-101-B*	309	PFLED-527*	343
LCLEDZ12-71*	344	N606-OB	210	P10-111*	309	PFLED-617*	343
LEW800-BLK*	194	N650-AB	211	P10-111-71*	309	PH100-51-F	158
LEW800-GT*	194	N650-OB	211	P10-111-MB*	309	PH100-51-J	156
LEW850-BLK*	195	N651-AB	212	P10-123-81*	310	PH100-52-F	158
LEW850-GT*	195	N651-OB	212	P10-130*	310	PH100-52-J	156
LEW875-BLK*	195 & 288	N651-PTR	212	P10-131-61*	310	PH100-61-F	158
LEW875-GT*	195 & 288	N652-OB	211	P10-131-71*	310	PH100-61-J	157
LL660-AB	287	NEW200-AB*	201	P10-150*	323	PH100-71-F	159
LL660-OB	287	NEW200-BLK*	201	P10-150-617*	323	PH100-71-J	157
LL660-PB	287	NEW200-SN*	201	P10-190-M*	339	PH100-91-F	159
LLED30-AB*	59	NEW250-AB*	202	P10-191-61*	339	PH100-91-J	156
LLED30-OB*	59	NEW250-BLK*	202	P10-191-61M*	339	PH101-52	160
LLED30-SN*	59	NEW250-SN*	202	P10-191-71*	340	PH10-170-PB*	323
LS201-MB*	251	NEW275-AB*	203 & 276	P10-191-81*	340	PH10-195-AB*	342
LS201-SP*	251	NEW275-BLK*	203 & 276	P10-192-617*	341	PH10-195-OB*	342
LS202-AB*	252	NEW275-SN*	203 & 276	P10-192-627*	341	PH10-195-PB*	342
LS202-MB*	252	OT600-AB-AM	214	P14-201*	311	PIN400-AB*	218
LS202-SP*	252	OT600-AB-GR	214	P14-201-81*	311	PIN400-OB*	218
LS206-AB*	253	OT600-AB-MS	214	P14-201-AB*	311	PIN400-SN*	218
LS206-MB*	253	OT600-AB-WT	214	P14-201-GT*	311	PIN450-AB*	219
LS206-SP*	253	OT600-OB-AM	214	P14-202*	313	PIN450-OB*	219
LS217-AB*	254	OT600-OB-GR	214	P14-202-81*	313	PIN450-SN*	219
LS217-MB*	254	OT600-OB-MS	214	P14-202-AB*	313	PIN475-AB*	220 & 270
LS217-SP*	254	OT600-OB-WT	214	P14-203*	315	PIN475-OB*	220 & 270
M600-BLKAB	196	OT600-SN-AM	214	P14-203-81*	315	PIN475-SN*	220 & 270
M600-BLKPN	196	OT600-SN-GR	214	P14-203-AB*	315	PL16-OB*	56
M601-BLKAB	197	OT600-SN-MS	214	P14-204*	317	PL16-WB*	56
M601-BLKPN	197	OT600-SN-WT	214	P14-204-81*	317	PL20-OB*	286
M650-BLKAB	198	OT650-AB-AM	215	P14-204-AB*	317	PL20-WB*	286
M650-BLKPN	198	OT650-AB-GR	215	P14-231-61*	318	PLED100-61*	327
M651-BLKAB	199	OT650-AB-MS	215	P14-231-71*	318	PLED100-527*	327
M651-BLKPN	199	OT650-AB-WT	215	P14-232-C71*	318	PLED100-617*	327
M675-BLKAB	200 & 288	OT650-OB-AM	215	P14-233-617*	319	PLED101-61*	324
M675-BLKPN	200 & 288	OT650-OB-GR	215	P14-233-C71*	319	PLED101-527*	324
MA14-AB*	344	OT650-OB-MS	215	P14-242-71*	319	PLED101-617*	324
MA14-B*	344	OT650-OB-WT	215	P14-250*	323	PLED192-617*	341
MA14-MB*	344	OT650-SN-AM	215	P14-250-617*	323	PLED192-627*	341
N600-AB	205	OT650-SN-GR	215	P14-280*	320	PR14-201-BLK/PN*	312
N600-AB-O	205	OT650-SN-MS	215	P14-280-WB*	320	PR14-202-AB/PB*	314
N600-OB	205	OT650-SN-WT	215	P14-290-ABMB*	321	PR14-203-MB/AB*	316
N600-OB-O	205	OT675-AB-AM	216 & 268	P14-290-MBAC*	321	PS10-190-M*	339
N601-AB	206	OT675-AB-GR	216 & 268	P14-290-SNBLK*	321	PS14-201-AB/PB*	312
N601-OB	206	OT675-AB-MS	216 & 268	P14-D01*	326	PS14-202-MB/AB*	314
N601-PTR	206	OT675-AB-WT	216 & 268	P15-81-5262	320	PS14-203-BLK/PN*	316
N602-AB	207	OT675-OB-AM	216 & 268	P15-83-52	320	PZLEDZ100-7*	328
N602-OB	207	OT675-OB-GR	216 & 268	P16-D02-617*	326	PZLEDZ100-52*	328
N603-AB	208	OT675-OB-MS	216 & 268	P16-D02-627*	326	PZLEDZ100-71*	328
N603-OB	208	OT675-OB-WT	216 & 268	PB14-201-MB/AB*	312	PZLEDZ101-7*	325
N603-PTR	208	OT675-SN-AM	216 & 268	PB14-202-BLK/PN*	314	PZLEDZ101-52*	325
N604-AB	209	OT675-SN-GR	216 & 268	PB14-203-AB/PB*	316	PZLEDZ101-71*	325
N604-OB	209	OT675-SN-MS	216 & 268	PFL-527*	343	R401-AB	222
N604-PTR	209	OT675-SN-WT	216 & 268	PFL-617*	343	R401-OB	222

INDEX

ITEM	PAGE	ITEM	PAGE	ITEM	PAGE	ITEM	PAGE
R450-AB	223	SL21-9*	7	SLEDZ29-91*	11	T14-5*	21
R450-OB	223	SL21-51*	7	SLEDZ43-51*	11	T14-31*	21
RR5-1*	25	SL21-52*	7	SLEDZ43-52*	11	T14-51*	21
RR8-1*	25	SL21-61*	7	SLEDZ43-61*	11	T14-52*	21
RR14-1*	25	SL21-62*	7	SLEDZ43-71*	11	T14-56*	21
RR24-1*	25	SL21-71*	7	SLEDZ43-91*	11	T14-61*	21
RR30-1*	25	SL21-76*	7	SP510-7	345	T14-71*	21
RU703-BLK*	226	SL21-91*	7	SP510-9	345	T14-76*	21
RU703-CHB*	225	SL30-7*	7	SP510-52	345	T14-81*	21
RU703-GT*	225	SL30-9*	7	SP520-7	345	T18-1*	21
RU703-WT*	226	SL30-51*	7	SP520-9	345	T18-5*	21
RU750-BLK*	227	SL30-52*	7	SP520-52	345	T18-31*	21
RU750-CHB*	227	SL30-61*	7	T4-1*	21	T18-51*	21
RU750-GT*	228	SL30-62*	7	T4-5*	21	T18-52*	21
RU750-WT*	228	SL30-71*	7	T4-31*	21	T18-56*	21
RU751-GT*	229	SL30-76*	7	T4-51*	21	T18-61*	21
RU751-WT*	229	SL30-91*	7	T4-52*	21	T18-71*	21
RU752-BLK*	230	SL40-7*	7	T4-56*	21	T18-76*	21
RU752-CHB*	230	SL40-9*	7	T4-61*	21	T18-81*	21
S900-AB	232	SL40-51*	7	T4-71*	21	T21-1*	21
S900-PN	232	SL40-52*	7	T4-76*	21	T21-5*	21
S901-AB	233	SL40-61*	7	T4-81*	21	T21-31*	21
S901-PN	233	SL40-62*	7	T5-1*	21	T21-51*	21
S950-AB	234	SL40-71*	7	T5-5*	21	T21-52*	21
S950-PN	234	SL40-76*	7	T5-31*	21	T21-56*	21
SL6-7*	7	SL40-91*	7	T5-51*	21	T21-61*	21
SL6-9*	7	SL64-7*	7	T5-52*	21	T21-71*	21
SL6-51*	7	SL64-9*	7	T5-56*	21	T21-76*	21
SL6-52*	7	SL64-51*	7	T5-61*	21	T21-81*	21
SL6-61*	7	SL64-52*	7	T5-71*	21	T24-1*	21
SL6-62*	7	SL64-61*	7	T5-76*	21	T24-5*	21
SL6-71*	7	SL64-62*	7	T5-81*	21	T24-31*	21
SL6-76*	7	SL64-71*	7	T8-1*	21	T24-51*	21
SL6-91*	7	SL64-76*	7	T8-5*	21	T24-52*	21
SL11-7*	7	SL64-91*	7	T8-31*	21	T24-56*	21
SL11-9*	7	SL84-7*	7	T8-51*	21	T24-61*	21
SL11-51*	7	SL84-9*	7	T8-52*	21	T24-71*	21
SL11-52*	7	SL84-51*	7	T8-56*	21	T24-76*	21
SL11-61*	7	SL84-52*	7	T8-61*	21	T24-81*	21
SL11-62*	7	SL84-61*	7	T8-71*	21	T30-1*	21
SL11-71*	7	SL84-62*	7	T8-76*	21	T30-5*	21
SL11-76*	7	SL84-71*	7	T8-81*	21	T30-31*	21
SL11-91*	7	SL84-76*	7	T9-1*	21	T30-51*	21
SL16-7*	7	SL84-91*	7	T9-5*	21	T30-52*	21
SL16-9*	7	SLEDZ15-51*	11	T9-31*	21	T30-56*	21
SL16-51*	7	SLEDZ15-52*	11	T9-51*	21	T30-61*	21
SL16-52*	7	SLEDZ15-61*	11	T9-52*	21	T30-71*	21
SL16-61*	7	SLEDZ15-71*	11	T9-56*	21	T30-76*	21
SL16-62*	7	SLEDZ15-91*	11	T9-61*	21	T30-81*	21
SL16-71*	7	SLEDZ29-51*	11	T9-71*	21	T36-1*	21
SL16-76*	7	SLEDZ29-52*	11	T9-76*	21	T36-5*	21
SL16-91*	7	SLEDZ29-61*	11	T9-81*	21	T36-31*	21
SL21-7*	7	SLEDZ29-71*	11	T14-1*	21	T36-51*	21

INDEX

ITEM	PAGE	ITEM	PAGE	ITEM	PAGE	ITEM	PAGE
T36-52*	21	TH751-OB	240	TR30-AB/PB*	21	USLEDZ41-51*	13
T36-56*	21	TH751-PN	240	TR30-BLK/PN*	21	USLEDZ41-52*	13
T36-61*	21	TH751-RB	240	TR30-MB/AB*	21	USLEDZ41-61*	13
T36-71*	21	TLEDZ14-1*	19	TR30-SN/PN*	21	USLEDZ41-62*	13
T36-76*	21	TLEDZ14-5*	19	TR36-AB/PB*	21	USLEDZ41-71*	13
T36-81*	21	TLEDZ14-31*	19	TR36-BLK/PN*	21	USLEDZ41-76*	13
T42-1*	21	TLEDZ14-51*	19	TR36-MB/AB*	21	USLEDZ41-91*	13
T42-5*	21	TLEDZ14-52*	19	TR36-SN/PN*	21	VG400-AB	244
T42-31*	21	TLEDZ14-56*	19	TS8-AB/PB*	21	VG450-AB	244
T42-51*	21	TLEDZ14-61*	19	TS8-BLK/PN*	21	W400-AB	245
T42-52*	21	TLEDZ14-71*	19	TS8-MB/AB*	21	W400-OB	245
T42-56*	21	TLEDZ14-76*	19	TS8-SN/PN*	21	W401-AB	246
T42-61*	21	TLEDZ14-81*	19	TS14-AB/PB*	21	W401-OB	246
T42-71*	21	TLEDZ24-1*	19	TS14-BLK/PN*	21	WL601-AB	255
T42-76*	21	TLEDZ24-5*	19	TS14-MB/AB*	21	WL601-OB	255
T42-81*	21	TLEDZ24-31*	19	TS14-SN/PN*	21	WL601-PC	255
TB8-AB/PB*	21	TLEDZ24-51*	19	TS21-AB/PB*	21	WL601-SN	255
TB8-BLK/PN*	21	TLEDZ24-52*	19	TS21-BLK/PN*	21	WL609-SB	256
TB8-MB/AB*	21	TLEDZ24-56*	19	TS21-MB/AB*	21	WL609-SN	256
TB8-SN/PN*	21	TLEDZ24-61*	19	TS21-SN/PN*	21	WL616-AB	257
TB14-AB/PB*	21	TLEDZ24-71*	19	TS24-AB/PB*	21	WL616-CB	257
TB14-BLK/PN*	21	TLEDZ24-76*	19	TS24-BLK/PN*	21	WL616-PB	257
TB14-MB/AB*	21	TLEDZ24-81*	19	TS24-MB/AB*	21	WL625-OB	258
TB14-SN/PN*	21	TLEDZ36-1*	19	TS24-SN/PN*	21	WL625-SN	258
TB21-AB/PB*	21	TLEDZ36-5*	19	TS30-AB/PB*	21	WL630-ABZ*	259
TB21-BLK/PN*	21	TLEDZ36-31*	19	TS30-BLK/PN*	21	WL630-SN*	259
TB21-MB/AB*	21	TLEDZ36-51*	19	TS30-MB/AB*	21	WL631-ABZ*	260
TB21-SN/PN*	21	TLEDZ36-52*	19	TS30-SN/PN*	21	WL631-SN*	260
TB24-AB/PB*	21	TLEDZ36-56*	19	TS36-AB/PB*	21	WL632-ABZ*	261
TB24-BLK/PN*	21	TLEDZ36-61*	19	TS36-BLK/PN*	21	WL632-SN*	261
TB24-MB/AB*	21	TLEDZ36-71*	19	TS36-MB/AB*	21	WS12-51-F	163 & 266
TB24-SN/PN*	21	TLEDZ36-76*	19	TS36-SN/PN*	21	WS12-51-J	161 & 264
TB30-AB/PB*	21	TLEDZ36-81*	19	USLEDZ15-7*	13	WS12-52-F	163 & 266
TB30-BLK/PN*	21	TR201-AB	242	USLEDZ15-9*	13	WS12-52-J	161 & 264
TB30-MB/AB*	21	TR201-SN	242	USLEDZ15-51*	13	WS12-61-F	163 & 266
TB30-SN/PN*	21	TR202-SN	242	USLEDZ15-52*	13	WS12-61-J	161 & 264
TB36-AB/PB*	21	TR8-AB/PB*	21	USLEDZ15-61*	13	WS12-71-F	164 & 267
TB36-BLK/PN*	21	TR8-BLK/PN*	21	USLEDZ15-62*	13	WS12-71-J	162 & 265
TB36-MB/AB*	21	TR8-MB/AB*	21	USLEDZ15-71*	13	WS12-91-F	164 & 267
TB36-SN/PN*	21	TR8-SN/PN*	21	USLEDZ15-76*	13	WS12-91-J	162 & 265
TH700-OB	236	TR14-AB/PB*	21	USLEDZ15-91*	13	WS14-9	167 & 282
TH700-PN	236	TR14-BLK/PN*	21	USLEDZ28-7*	13	WS14-51	166 & 281
TH700-RB	236	TR14-MB/AB*	21	USLEDZ28-9*	13	WS14-52	166 & 281
TH701-OB	237	TR14-SN/PN*	21	USLEDZ28-51*	13	WS14-61	166 & 281
TH701-PN	237	TR21-AB/PB*	21	USLEDZ28-52*	13	WS14-71	167 & 282
TH701-RB	237	TR21-BLK/PN*	21	USLEDZ28-61*	13	WS14-91	167 & 282
TH725-OB	238 & 289	TR21-MB/AB*	21	USLEDZ28-62*	13	WS14-2-52	165 & 280
TH725-PN	238 & 289	TR21-SN/PN*	21	USLEDZ28-71*	13	WS14-2-71	165 & 280
TH725-RB	238 & 289	TR24-AB/PB*	21	USLEDZ28-76*	13	WS14-2-91	165 & 280
TH750-OB	239	TR24-BLK/PN*	21	USLEDZ28-91*	13	WS16-31	290
TH750-PN	239	TR24-MB/AB*	21	USLEDZ41-7*	13	WS16-61	290
TH750-RB	239	TR24-SN/PN*	21	USLEDZ41-9*	13	WS16-91	290

INDEX

ITEM	PAGE	ITEM	PAGE	ITEM	PAGE	ITEM	PAGE
WS-704*	292	WS760-AS	296	XL14-71*	9	ZLEDZ12-62*	17
WS-706*	291	WS760-OB	296	XL14-91*	9	ZLEDZ12-71*	17
WS-706-AB*	291	WS761-AB	297	XL24-51*	9	ZLEDZ12-91*	17
WS-706-OB*	291	WS761-AS	297	XL24-52*	9	ZLEDZ24-51*	17
WS-708-AB*	292	WS761-OB	297	XL24-61*	9	ZLEDZ24-52*	17
WS-708-OB*	292	WS763-AB	298	XL24-62*	9	ZLEDZ24-62*	17
WS750-AB	293	WS763-AS	298	XL24-71*	9	ZLEDZ24-71*	17
WS750-AS	293	WS763-OB	298	XL24-91*	9	ZLEDZ24-91*	17
WS750-OB	293	WS775-OB	299	XL36-51*	9	ZLEDZ36-51*	17
WS751-AB	294	WS775-SN	299	XL36-52*	9	ZLEDZ36-52*	17
WS751-AS	294	WS776-OB	300	XL36-61*	9	ZLEDZ36-62*	17
WS751-OB	294	WS776-PN	300	XL36-62*	9	ZLEDZ36-71*	17
WS752-AB	295	XL14-51*	9	XL36-71*	9	ZLEDZ36-91*	17
WS752-AS	295	XL14-52*	9	XL36-91*	9		
WS752-OB	295	XL14-61*	9	ZLEDZ12-51*	17		
WS760-AB	296	XL14-62*	9	ZLEDZ12-52*	17		

*MADE IN US





\$15

American Lighting Brands

Arroyo Craftsman Framburg House of Troy Scatchard Stoneware Thumprints



FRAMBURG



Scatchard Stoneware



902 Silver Ridge Road Hyde Park, VT 05655 PH 800-428-5367 FAX 888-881-7952
americanlightingbrands.com