

Thank you for purchasing this quality product. Be sure to unpack carefully looking for small parts which may have come loose during shipment.

Read all instruction and study the drawing carefully before starting the assembly process.

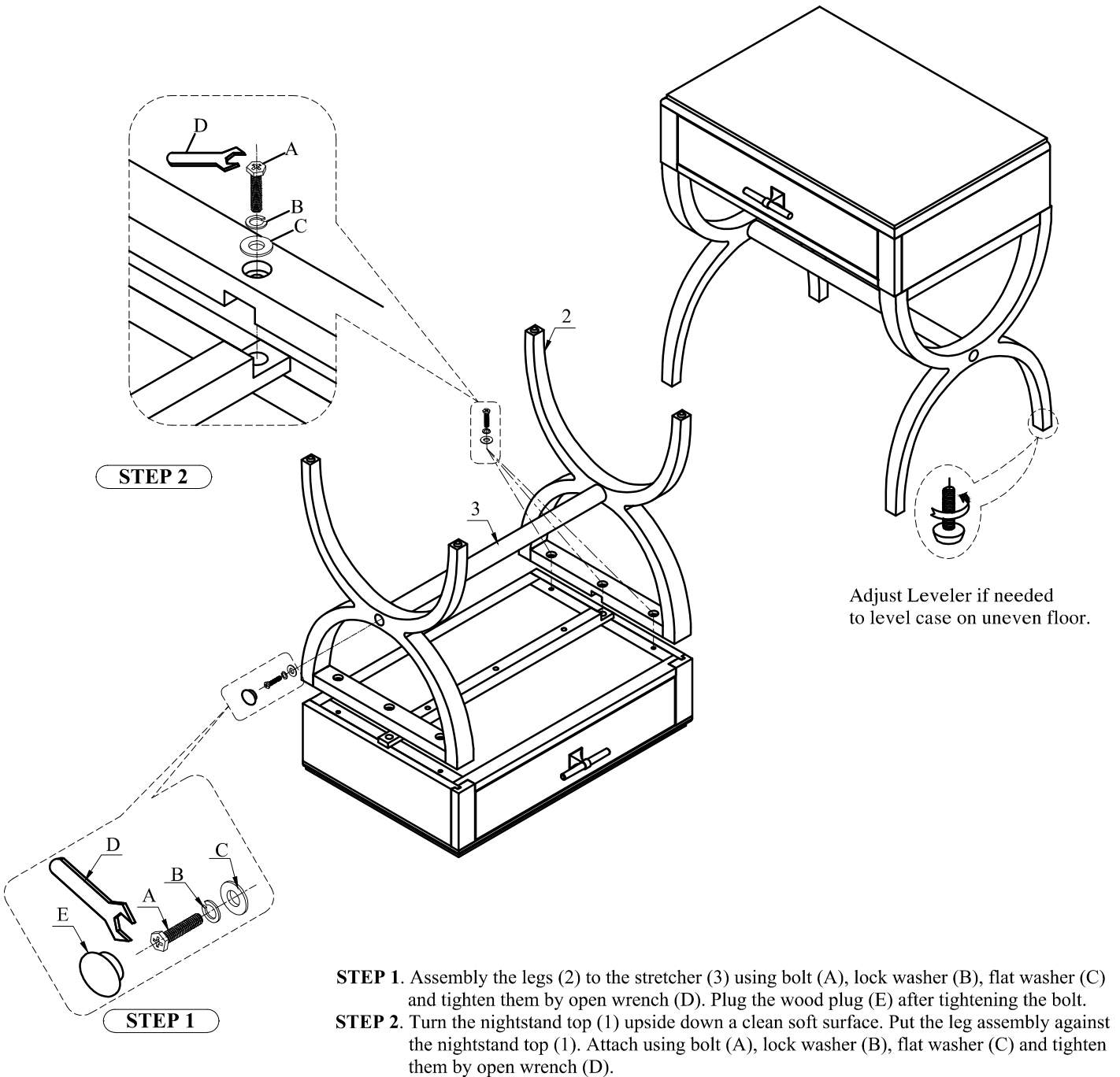



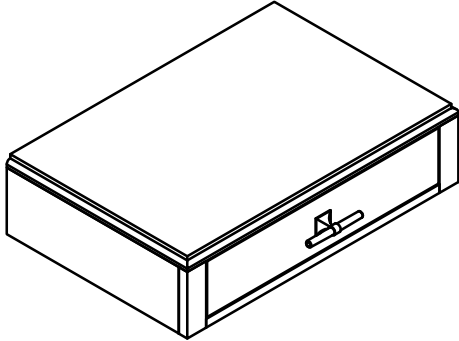
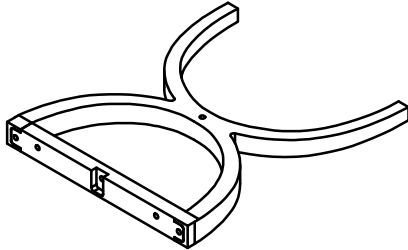
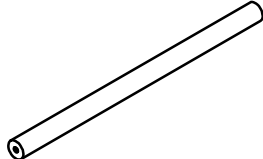

Item: 6050-90015 Leg Nightstand

PARTS LIST

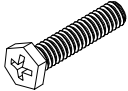
Item No	Drawing	Description	Qty
1		Nightstand Top	1 pc
2		Leg	2 pcs
3		Stretcher	1 pc

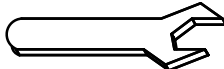
HARDWARE LIST

NO	DRAWING	DESCRIPTION	SIZE	Q'ty
A		Hexagonal Bolt	ϕ1/4"*1-1/2"	8pcs
B		Lock Washer	ϕ1/4"	8pcs
C		Flat Washer	ϕ1/4"*19D	8pcs
D		Open Wrench	11mm	1pc
E		Wood Plug Ø41*18mm	ϕ34*16	2pc