

Family: Flynn | Item No. 5822 BH

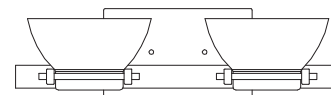

Drawing 1 - Fixture Mounting

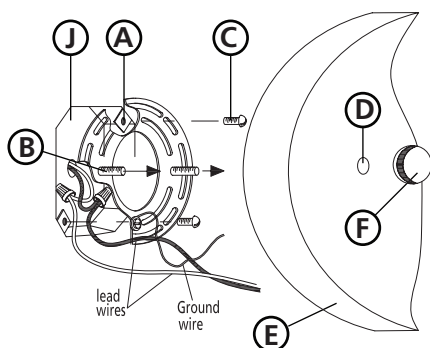

Drawing 2 - Glass Installation

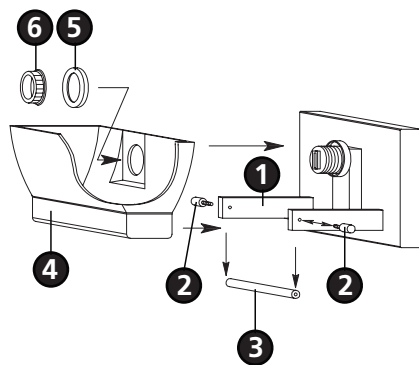

▼ start here

- 1**
 1. Find a clear area in which you can work.
 2. Unpack fixture and glass from carton.
 3. Carefully review instructions prior to assembly.

***** The construction of this fixture will be accomplished by first mounting the mounting strap to the junction box, making all necessary electrical connections, mounting the fixture to the wall, and then installing the fixture glass.**

- 2**
 1. Prepare mounting strap **(A)** by threading the two 1 1/4" long mounting screws **(B)** into the back of the mounting strap **(A)** - see **Drawing 1**.
 - Be sure the holes into which the screws are threaded match the spacing of holes **(D)** in the backplate **(E)**.

SAFETY WARNING: READ WIRING AND GROUNDING INSTRUCTIONS (I.S. 18) AND ANY ADDITIONAL DIRECTIONS. TURN POWER SUPPLY OFF DURING INSTALLATION. IF NEW WIRING IS REQUIRED, CONSULT A QUALIFIED ELECTRICIAN OR LOCAL AUTHORITIES FOR CODE REQUIREMENTS.

- 3**
 1. Make electrical connections from supply wire to fixture lead wires. Refer to instruction sheet **(I.S. 18)** and follow all instructions to make all necessary wiring connections. Then refer back to this sheet to continue installation of this fixture.

- 4**
 1. To mount fixture, slip the two mounting screws **(B)** through the two mounting holes **(D)** in the backplate **(E)** - see **Drawing 1**.
 2. While holding fixture in place, thread the two ball knobs **(F)** on to the end of the mounting screws **(B)**, and tighten.

- 5**
 1. To install glass, remove barrel knob **(2)** from both ends of center bar **(3)**, located between the two arms **(1)** - see **Drawing 2**.
 2. Slip hole in back of glass **(4)** over socket.
 3. Slip spacer **(5)** over socket and thread socket ring **(6)** onto socket to secure glass **(4)**.
 4. Replace center bar **(3)** and secure it between arms **(1)**, with barrel knobs **(2)**.
 5. Fixture can now be lamped accordingly.
 6. Thread glass bulb shield over lamp.

Note: Maximum wattage for 5822 fixture is 60 watts per G9 bulb.

11.2.09