

Family: Lanza | Item No. 5102 AN/BR

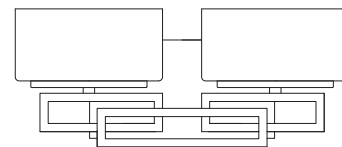

Drawing 1 - Fixture Mounting

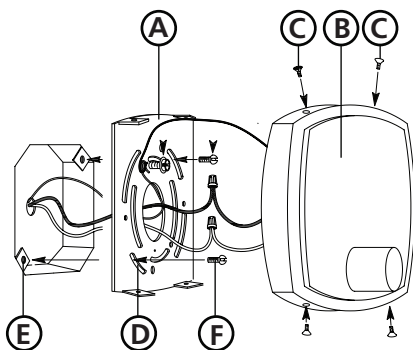

Drawing 2 - Glass Installation

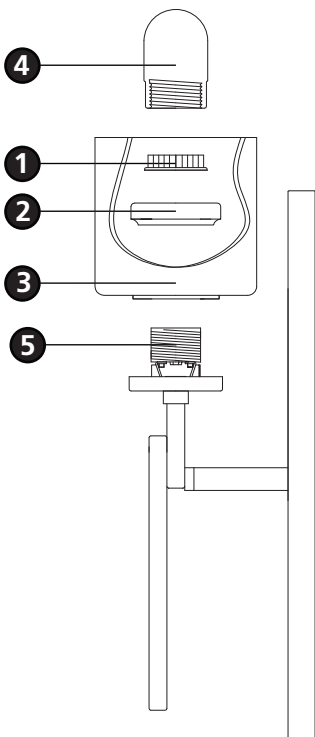

▼ start here

1

1. Find a clear area in which you can work.
2. Unpack fixture and glass from carton.
3. Carefully review instructions prior to assembly.

***** The construction of this fixture will be accomplished by first attaching the mounting strap to the junction box, making all necessary electrical connections, mounting the fixture to the wall and then installing the glass.**

2

1. Remove main mounting plate (A) from fixture back plate (B) by removing the four flat head screws (C) - see **Drawing 1**.
2. Slide the wires from the junction box, through the large center hole, making sure curved slots (D) line up with the threaded holes (E) in the junction box.
3. Using two 8-32 screws (F) attach the main mounting plate (A) to the junction box, making sure top of mounting plate (A) is parallel to ceiling.

SAFETY WARNING: READ WIRING AND GROUNDING INSTRUCTIONS (I.S. 18) AND ANY ADDITIONAL DIRECTIONS. TURN POWER SUPPLY OFF DURING INSTALLATION. IF NEW WIRING IS REQUIRED, CONSULT A QUALIFIED ELECTRICIAN OR LOCAL AUTHORITIES FOR CODE REQUIREMENTS.

3

Make electrical connections from supply wire to fixture lead wires. Refer to instruction sheet (I.S. 18) and follow all instructions to make all necessary wiring connections. Then refer back to this sheet to continue installation of this fixture.

4

1. Mount the fixture by sliding the back plate (B) over mounting plate (A) - see **Drawing 1**.
2. Attach the back plate (B) to the mounting plate using the screws (F).

5

1. To install glass, remove socket ring (1) and spacer (2) from the socket (5) - see **Drawing 2**.
2. Slip glass (3) over socket (5).
3. Slip spacer (2) and thread socket ring (1) onto socket (5) to secure glass (3).
4. Fixture can now be lamped accordingly.
5. Thread glass shield (4) onto socket (5).

Note: Maximum wattage for 5102 fixture is 60 watts G9 halogen per bulb.

4.15.09