

**Locarno**  
**Pressure Balance Trim**  
 Part no. : **04822xx0**



**Description**

**Features**

- Flow: 5.44 GPM (20.6 L/Min)
- Integrated bypass for use with diverter tub spouts
- Temperature and on/off control for 1 outlet

**Item details**

**Compliance**

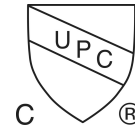

**Product image**



**Scale drawing**

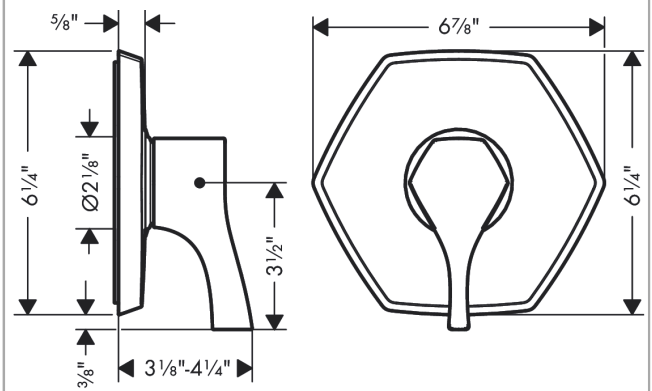

**Locarno**  
**Showerarm, 9"**  
 Part no. : **04826xx0**



**Description**

**Features**

- solid Brass
- connection type: 1/2" NPT
- 1/2" NPT
- Escutcheon, Showerarm

**Item details**

**Compliance**

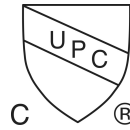

**Product image**

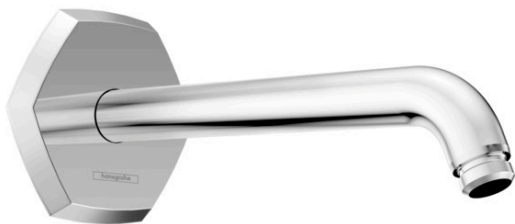

**Scale drawing**

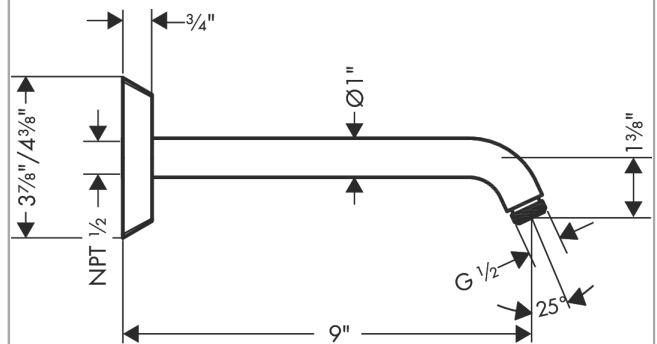

**Locarno**  
**Showerhead 240 1-Jet, 2.5 GPM**  
 Part no. : 04823xx0



**Description**

**Features**

- Spray modes: PowderRain
- Fully-finished matching spray face

**Item details**

**Technology**



**Compliance**

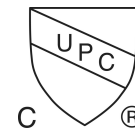

**Product image**



**Scale drawing**

