

DESCRIPTION

Miniature size, decorator finishes, push-in connectors, economy, all combine to make single-circuit Miniature Trac perfect for residential or commercial use. Polarized connectors and end caps are molded polycarbonate. Halo Miniature Track accepts both Halo and Lazer-by-Halo lampholders.

Catalog #		Type
Project		
Comments		Date
Prepared by		

SPECIFICATION FEATURES

A. Structural

- Extruded aluminum .060" [1.5mm] nominal wall thickness

B. Line Conductor

- Solid copper bus bars [cross section equivalent to #12 AWG wire].

C. Insulating Liner

- Extruded polyvinyl insulator.

D. Ground Conductor

- Exclusive independent grounding bus conductor. Maintains an independent positive ground #12 AWG path between lampholder, Trac channel and building's ground system.

E. Neutral Conductor

- Cross section equivalent of #12 AWG wire.

F. Polarity Indicator (Neutral)

- Visual polarity groove indicates proper electrical installation of lampholder adapter.

Listings

- cULus listed for use with Halo and Lazer-by-Halo lampholders.

Mounting

- Track system is recommended for ceiling mount only. For alternate mounting methods consult factory.

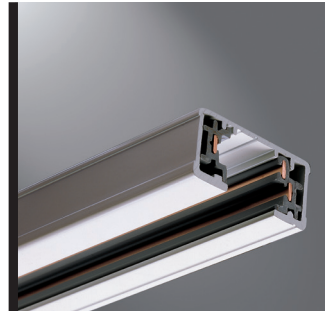

**L650, L651
L652, L653**

**MINIATURE
SINGLE CIRCUIT
TRAC SYSTEM**

Power -Trac

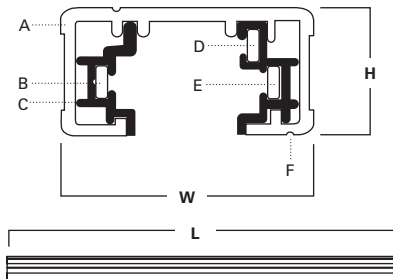

	L	W	H
L650 2' Nominal	20-1/8" [511mm]	1-3/8" [35mm]	11/16" [18mm]
L651 4' Nominal	44-1/8" [1121mm]	1-3/8" [35mm]	11/16" [18mm]
L652 8' Nominal	92-1/8" [2340mm]	1-3/8" [35mm]	11/16" [18mm]
L653 12' Nominal	140-1/8" [3559mm]	1-3/8" [35mm]	11/16" [18mm]

ORDERING INFORMATION

SAMPLE NUMBER: L651MB

Track	Finishes	Connectors (Order Separately)	Accessories (Order Separately)	Current Limiters (Order Separately)
L650= 2' L651= 4' L652= 8' L653= 12'	P=White MB=Black	L900=Outlet Box Cover L901=Live End Connector L902=Flexible Connector L903=Straight Connector L904=L Connector L905=T Connector L906=X Connector L907=Outlet Box for use with T-Bar ceiling L908=Mini Joiner L909=Floating Canopy and Connector L950=Cord and Plug Connector L979=Conduit Continuation Kit L980=Live End Conduit Adapter DE600=Dead End Finishes P=White MB=Black	L951=Wire Way Cover for Pendant Assembly Kit L983=T-Bar Attachment Clip L992=Pendant Kit Assembly L48=48" Steel Stem L994=Pendant Adapter Finishes P=White MB=Black	Current Limiter - End Feed LC901CB120=120W (1A @ 120V) LC901CB300=300W (2.5A @ 120V) LC901CB600=600W (5A @ 120V) LC901CB960=960W (8A @ 120V) LC901CB1200=1200W (10A @ 120V) Current Limiter - Center Feed LC903CB120=120W (1A @ 120V) LC903CB300=300W (2.5A @ 120V) LC903CB600=600W (5A @ 120V) LC903CB960=960W (8A @ 120V) LC903CB1200=1200W (10A @ 120V) Finishes P=White MB=Black

LC901, LC903 Current Limiter - End and Center Feeds

End-feed and Center-feed capable:
 Five breaker sizes are available. Consult factory if other sizes are required. Can be utilized on hard or grid ceilings.
 Can be used with pendant suspended track. Breaker can be used as an on-off switch. Breaker features a "tripped" condition indicator. cULus Listed.

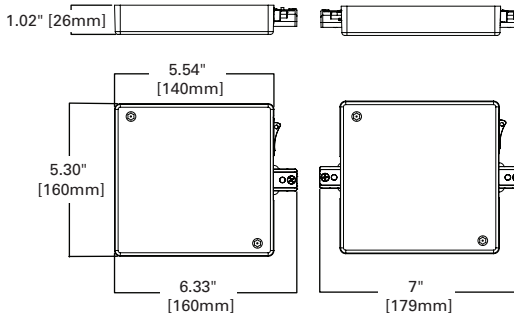

**LC901
LC903**

ORDERING INFORMATION

SAMPLE NUMBER: LC901CB120P

Feed Type	Circuit 1 Breaker	Finish
LC901= Halo Power-Trac 1-Circuit End Feed	CB120=120W (1A @120V)	P=White MB=Black
LC903= Halo Power-Trac 1-Circuit Center Feed	CB300=300W (2.5A @120V) CB600=600W (5A @120V) CB960=960W (8A @120V) CB1200=1200W (10A @120V)	

Sample catalog number: LC901CB120P

Consult factory for Single Circuit Center-feed requiring two circuit breakers.



L900 - Outlet Box Cover

Can be used at any electrical feed connection point (Live, Straight, L, T or X). Drill guides on back for virtually all standard outlet boxes. Size: 5" sq. Screws included.
Color codes: P (White), MB (Black)

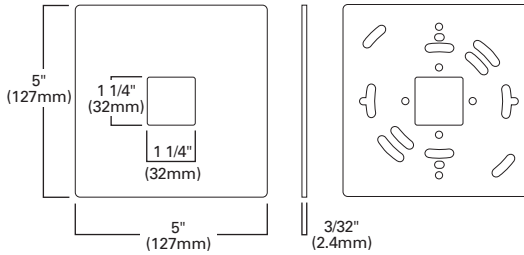

L900

ORDERING INFORMATION

SAMPLE NUMBER: L900P

Connector	Finish
L900= Outlet Box Cover	P=White MB=Black

L901 - Live End Connector

To start a run.
Color codes: P (White), MB (Black)

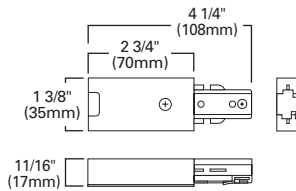

L901

ORDERING INFORMATION

SAMPLE NUMBER: L901P

Connector	Finish
L901= Live End Connector	P=White MB=Black

L902 - Flexible Connector

To connect two track sections at any angle up to 90° in either plane or wall to ceiling or pitched ceiling applications.

Color codes: P (White), MB (Black)

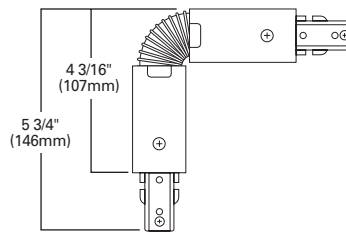

L902

ORDERING INFORMATION

SAMPLE NUMBER: L902P

Connector	Finish
L902= Flexible Connector	P=White MB=Black

L903 - Straight Connector

To connect two track sections end-to-end. L903 differs from mini connector L908 in that it provides a center feed option and is longer. May be used as feed point.

Color codes: P (White), MB (Black)

ORDERING INFORMATION

SAMPLE NUMBER: L903P

Connector	Finish
L903= Straight Connector	P=White MB=Black

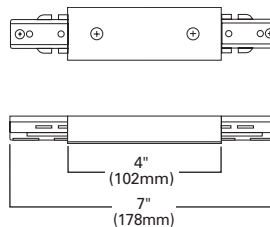

L903

L904 - L Connector

To connect two track sections at a right angle. Field adjustable for either right hand or left hand application. May be used as feed point.

Color codes: P (White), MB (Black)

ORDERING INFORMATION

SAMPLE NUMBER: L904P

Connector	Finish
L904= L Connector	P=White MB=Black

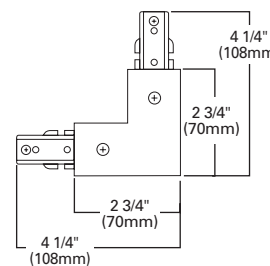

L904

L905 - T Connector

To connect three track sections into a T configuration. Field adjustable for either right hand or left hand application. May be used as feed point.

Color codes: P (White), MB (Black)

ORDERING INFORMATION

SAMPLE NUMBER: L905P

Connector	Finish
L905= T Connector	P=White MB=Black

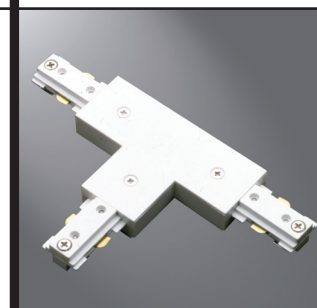
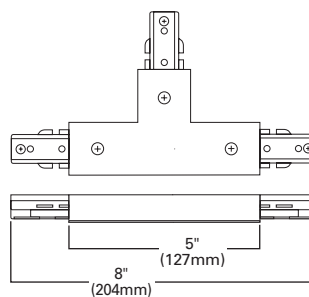

L905

L906 - X Connector

To connect four track sections into a cross configuration. May be used as feed point.

Color codes: P (White), MB (Black)

ORDERING INFORMATION

SAMPLE NUMBER: L906P

Connector	Finish
L906= X Connector	P=White MB=Black

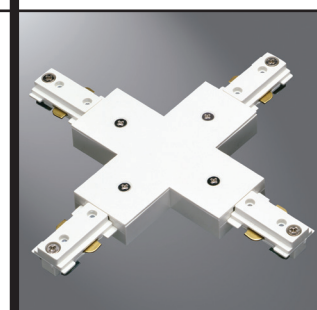
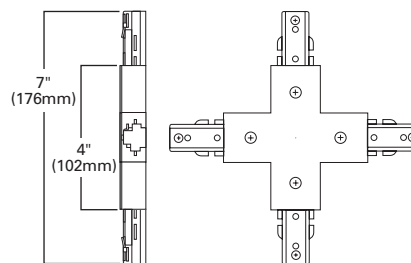

L906

L907 - Outlet Box for use with T-Bar Ceiling

L901, L903, L904, L905 or L906 connector also required. 4" x 4" x 1 1/8".

Color codes: P (White), MB (Black)

ORDERING INFORMATION

SAMPLE NUMBER: L907P

Connector	Finish
L907= Outlet Box for use with T-Bar Ceiling	P=White MB=Black

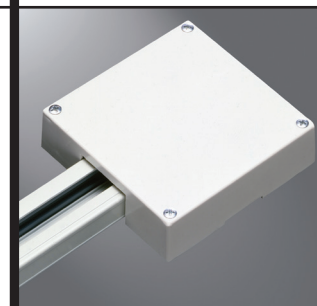
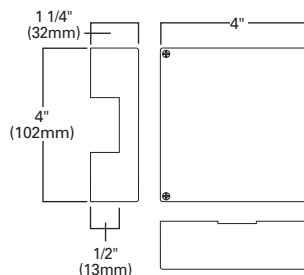

L907

L908 - Mini Joiner

A low profile connector to cleanly and crisply join two straight track sections end-to-end. (Note: The L908 is not a feed point).

Color codes: P (White), MB (Black)

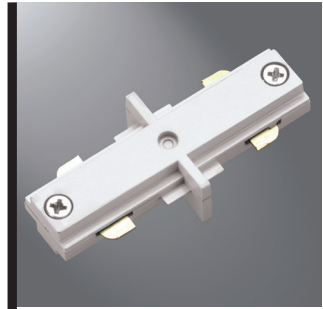
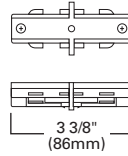

L908

ORDERING INFORMATION

SAMPLE NUMBER: L908P

Connector	Finish
L908= Mini Joiner	P=White MB=Black

L909 - Floating Canopy and Connector

Track can be connected to existing outlet box located anywhere along the track. Comes with canopy cover, connector, dead-end and mounting hardware.

4 1/8" x 4 1/4" x 1 3/8"

Color codes: P (White), MB (Black)

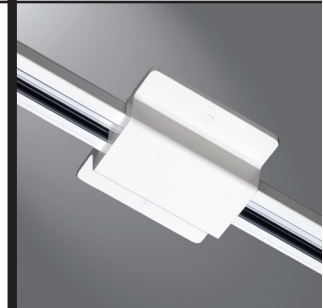
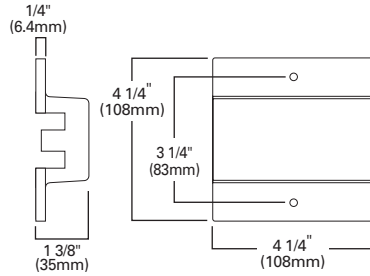

L909

ORDERING INFORMATION

SAMPLE NUMBER: L909P

Connector	Finish
L909= Floating Canopy and Connector	P=White MB=Black

L950 - Cord and Plug Connector

12' three-wire cord with grounded plug. Maximum capacity 10 AMP.

Color codes: P (White), MB (Black)

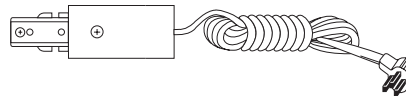

L950

ORDERING INFORMATION

SAMPLE NUMBER: L950P

Connector	Finish
L950= Cord and Plug Connector	P=White MB=Black

L951 - Wire Way Cover for Pendant Assembly Kit

For track to be wired through stem (order one for each feed point used). For use with line connectors (L901, L902, L903, L904, L905 or L906) and pendant stem kit (L992)–order separately.

Color codes: P (White), MB (Black)

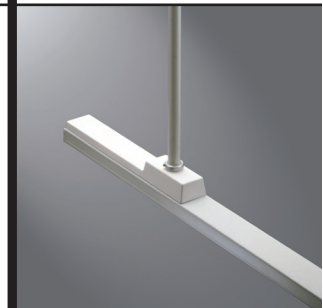
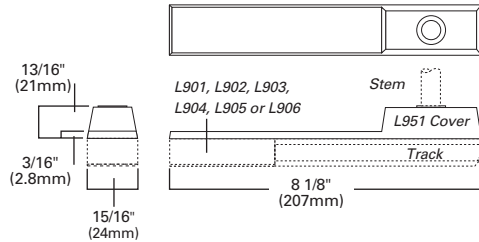

L951

ORDERING INFORMATION

SAMPLE NUMBER: L951P

Connector	Finish
L951= Wire Way Cover for Pendant Assembly Kit	P=White MB=Black

L979 - Conduit Continuation Kit

Consisting of one left feed and one right feed. To continue a run around obstructions. Designed to accept 1/2" trade size conduit fitting (not included).

Color codes: P (White), MB (Black)

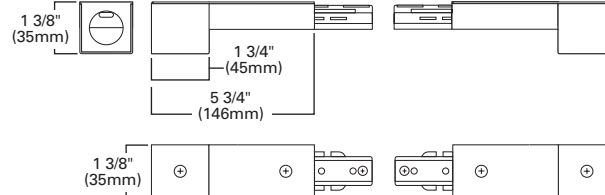

L979

ORDERING INFORMATION

SAMPLE NUMBER: L979P

Connector	Finish
L979= Conduit Continuation Kit	P=White MB=Black

L980 - Live End Conduit Adapter

Designed to accept standard 1/2" trade size conduit fitting (not supplied). Use when feeding to track through surface conduit system.

Color codes: P (White), MB (Black)

ORDERING INFORMATION

SAMPLE NUMBER: L980P

Connector	Finish
L980= Live End Conduit Adapter	P=White MB=Black

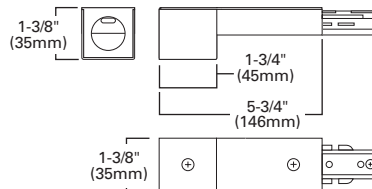

L980

L983 - T-Bar Attachment Clip

Allows track to be attached to inverted tee ceiling. Order as follows: 2 kits for 2' Trac; 2 kits for 4' Trac; 3 kits for 8' Trac and 4 kits for 12' Trac.

L986 Mini-T Bar Clip

For mounting Trac on suspended ceilings with mini-grid (9/16" wide) system.

ORDERING INFORMATION

SAMPLE NUMBER: L983P

Connector	Finish
L983= T-Bar Attachment Clip L986= Mini T-Bar Clip	P=White MB=Black

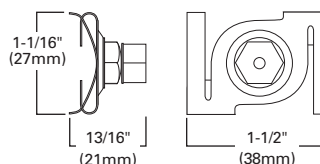

L983

L992 - Pendant Kit Assembly

Order 2 kits for 2' Trac; 2 kits for 4' Trac; 3 kits for 8' Trac; and 4 kits for 12' Trac. Includes one 18" threaded steel stem, canopy and mounting hardware.

L48 48" Steel Stem

For additional length with L992. Can be field cut.

Color codes: P (White), MB (Black)

ORDERING INFORMATION

SAMPLE NUMBER: L992P

Connector	Finish
L992= Pendant Kit Assembly	P=White MB=Black

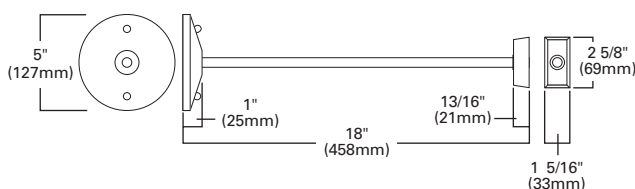

L992

L994 - Pendant Adapter

For installing pendant mounted Power-Trac on sloped ceiling. For use with L992.

Color codes: P (White), MB (Black)

ORDERING INFORMATION

SAMPLE NUMBER: L994P

Connector	Finish
L994= Pendant Adapter	P=White MB=Black

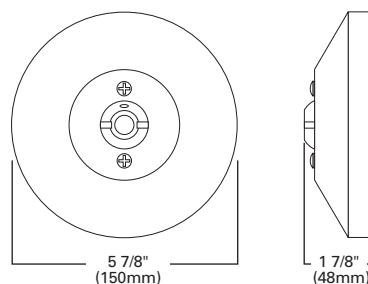

L994

DE600 - Dead End

Color codes: P (White), MB (Black)

ORDERING INFORMATION

SAMPLE NUMBER: DE600P

Connector	Finish
DE600= Dead End	P=White MB=Black



DE600