

5 5/8" Tubular Shower Arm

MODEL # 27414

Pure Freude an Wasser

GROHE

GROHE America, Inc | 200 North Gary Avenue, Suite G, Roselle, IL 60172
Phone: +1 (800) 444-7643 | Fax: +1 (800) 225-2778 | us-customerservice@grohe.com



Product Description:
5 5/8" Tubular Shower Arm

Standard Specification:

- GROHE StarLight® finish
- 1/2" Connection thread
- Projection 5 5/8"

Applicable Codes & Standards:

- Energy Policy Act of 1992
- ASME A112.18.1/CSA B125.1

Color:

- 27414 000 chrome
- 27414 EN0 Brushed Nickel

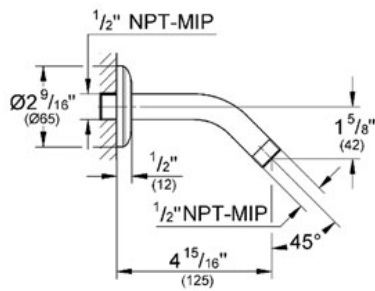

EUPHORIA CUBE+ STICK Shower Set

MODEL # 27891

Pure Freude an Wasser

GROHE

GROHE America, Inc | 200 North Gary Avenue, Suite G, Roselle, IL 60172
Phone: +1 (800) 444-7643 | Fax: +1 (800) 225-2778 | us-customerservice@grohe.com

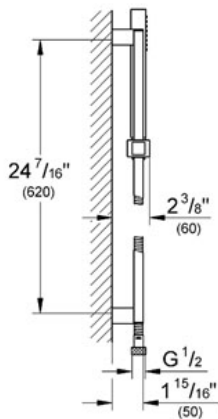

Product Description: Shower Set

Standard Specification:

- GROHE StarLight® finish
- GROHE DreamSpray® perfect spray pattern
- GROHE CoolTouch®
- GROHE EcoJoy® technology for less water and perfect flow
- SpeedClean anti-lime system
- Inner WaterGuide for a longer life
- Suitable for instantaneous heater

Consisting of:

- Hand shower, metal (27 888 000)
- 24" Shower rail (27 892 000)
- 69" metal shower hose (28 025 000)
- Twistfree to prevent hose from twisting
- Max Flow Rate 2.5 gpm at 80 psi (9.5 L/min)

Applicable Codes & Standards:

- Energy Policy Act of 1992
- ASME A112.18.1/CSA B125.1

Color:

- 27891 000 chrome

GROHFLEX™
 Universal Rough-In Box
 MODEL # 35026

Pure Freude an Wasser



GROHE America, Inc | 200 North Gary Avenue, Suite G, Roselle, IL 60172
 Phone: +1 (800) 444-7643 | Fax: +1 (800) 225-2778 | us-customerservice@grohe.com

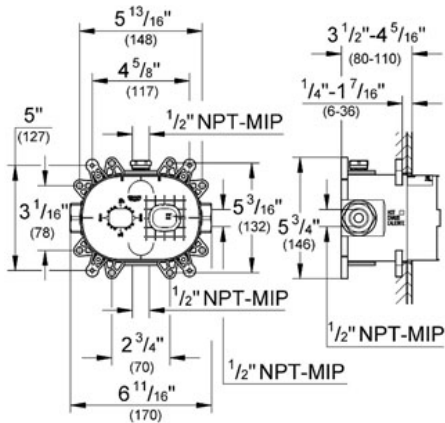
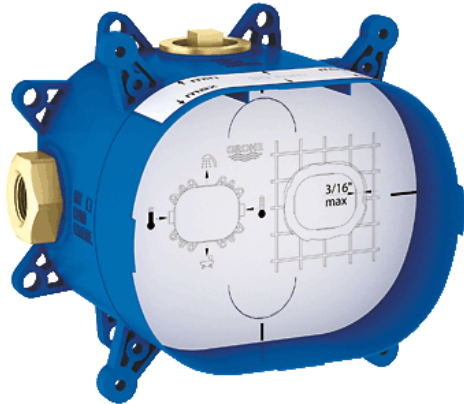

Product Description:
 Universal Rough-In Box

Standard Specification:

- Inlets and outlets 1/2"
- Fixing points for front and back wall
- Leakproof housing
- Integrated service stops
- Flushing plug
- Removable protection cover with installation information
- For use with the GrohFlex Bathroom Solution Kits (sold separately):
 - Pressure Balance Valves and Thermostats
 - Single Function, Dual Function or Custom Shower

Applicable Codes & Standards:

- Energy Policy Act of 1992
- ASME A112.18.1/CSA B125.1

Color:

□ 35026 000

NEW TEMPESTA
 COSMOPOLITAN 100
 Head shower 4 sprays
 MODEL # 27591

Pure Freude an Wasser



GROHE America, Inc | 200 North Gary Avenue, Suite G, Roselle, IL 60172
 Phone: +1 (800) 444-7643 | Fax: +1 (800) 225-2778 | us-customerservice@grohe.com

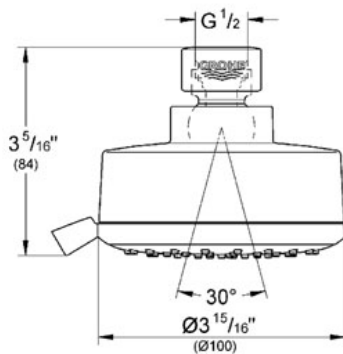

Product Description:
 Head shower 4 sprays

Standard Specification:

- GROHE StarLight® finish
- GROHE DreamSpray® perfect spray pattern Ø 4"
- GROHE EcoJoy® technology for less water and perfect flow
- 1/2" Connection thread
- SpeedClean anti-lime system
- Inner WaterGuide for a longer life
- Suitable for instantaneous heater
- GROHE Rain O2, Rain, • Rotating ball joint ± 15°
- Min. recommended pressure 15 psi
- Max Flow Rate 2.5 gpm (9.5 L/min)

Applicable Codes & Standards:

- Energy Policy Act of 1992
- ASME A112.18.1/CSA B125.1

Color:

- 27591 000 chrome
- 27591 EN0 Brushed Nickel

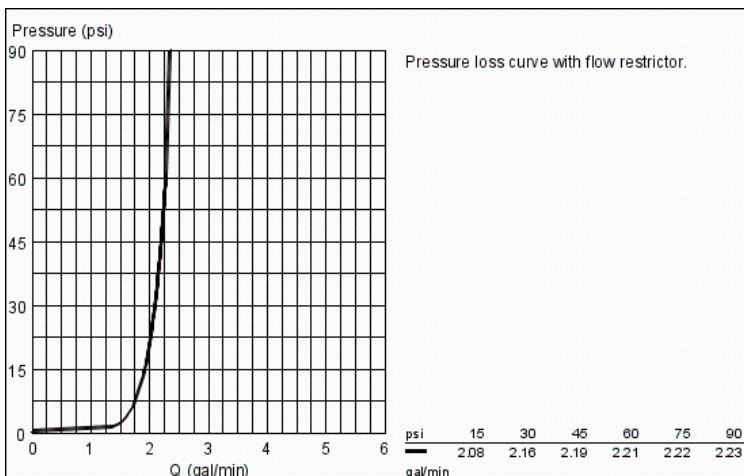

EUROCUBE

Dual function thermostatic trim with control module

MODEL # 19927

GROHE America, Inc | 200 North Gary Avenue, Suite G, Roselle, IL 60172
 Phone: +1 (800) 444-7643 | Fax: +1 (800) 225-2778 | us-customerservice@grohe.com

Pure Freude an Wasser

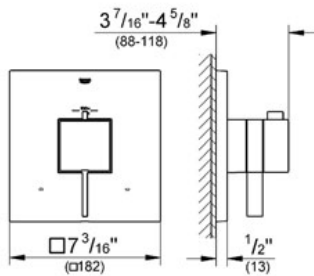

Product Description:
 Dual function thermostatic trim with control module

- Standard Specification:**
- GROHE TurboStat® technology
 - For shower/tubs with non-diverter tub spout or for 2 shower outlet applications
 - Integrated volume control
 - 2-way diverter function
 - 1 axis operation
 - For use with GrohFlex™ universal rough-in box 35 026 000 sold separately
 - Max Flow Rate 6.6 gpm (25 L/min)

- Applicable Codes & Standards:**
- Energy Policy Act of 1992
 - ASME A112.18.1/CSA B125.1
 - US Federal and State material regulations

Color:
 19927 000 chrome

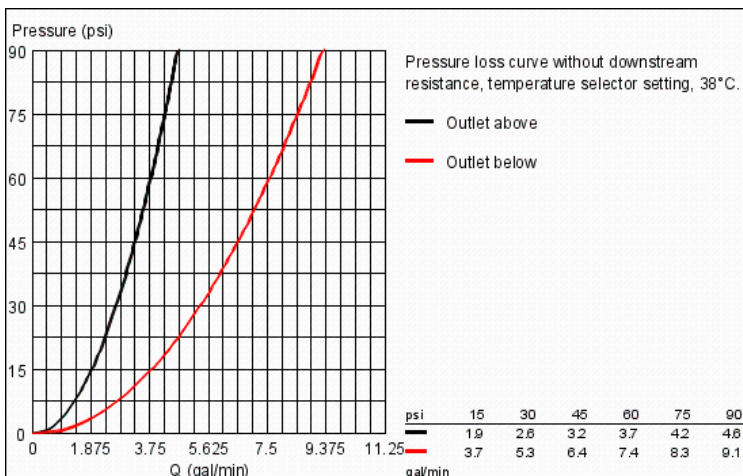

EUROCUBE
Tub Spout
MODEL # 13307

Pure Freude an Wasser



GROHE America, Inc | 200 North Gary Avenue, Suite G, Roselle, IL 60172
Phone: +1 (800) 444-7643 | Fax: +1 (800) 225-2778 | us-customerservice@grohe.com

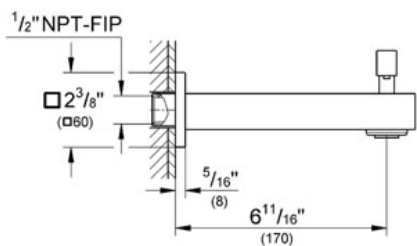

ADA

Product Description:
Tub Spout

Standard Specification:

- GROHE StarLight® finish
- Wall mount
- Flow control
- Automatic diverter: bath/shower
- 1/2" NPT Female thread
- Projection 6 11/16"
- Max FLOW Rate 6.9 gpm at 45 psi (26.1 L/min),
2.5 gpm (9.5 L/min) for Shower Hand

Applicable Codes & Standards:

- Energy Policy Act of 1992
- ASME A112.18.1/CSA B125.1
- US Federal and State material regulations
- ICC/ANSI A117.1

Color:

- 13307 000 chrome

ALLURE BRILLIANT Shower outlet elbow

MODEL # 27708

Pure Freude an Wasser



GROHE America, Inc | 200 North Gary Avenue, Suite G, Roselle, IL 60172
Phone: +1 (800) 444-7643 | Fax: +1 (800) 225-2778 | us-customerservice@grohe.com



Product Description:
Shower outlet elbow

Standard Specification:

- GROHE StarLight® finish
- 1/2" NPT Male Threads
- Protected against backflow

Applicable Codes & Standards:

- Energy Policy Act of 1992
- ASME A112.18.1/CSA B125.1

Color:

- 27708 000 chrome

