

# RAINSHOWER® 16" Shower Arm

MODEL # 28540

*Pure Freude an Wasser*

**GROHE**

GROHE America, Inc | 200 North Gary Avenue, Suite G, Roselle, IL 60172  
Phone: +1 (800) 444-7643 | Fax: +1 (800) 225-2778 | us-customerservice@grohe.com

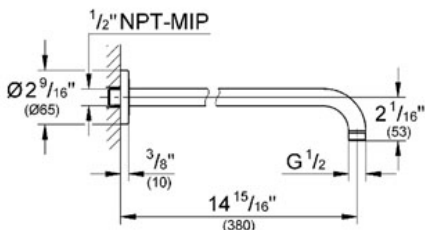

#### Product Description:

##### 16" Shower Arm

#### Standard Specification:

- GROHE StarLight® finish
- 1/2" NPT Male Threads
- Can be used with all Rainshower shower heads except Rainshower Jumbo

#### Applicable Codes & Standards:

- Energy Policy Act of 1992
- ASME A112.18.1/CSA B125.1

#### Color:

- 28540 000 chrome
- 28540 BE0 Sterling inf
- 28540 EN0 Brushed Nickel
- 28540 KS0 velvet black
- 28540 LS0 moon white
- 28540 ZB0 Oil Rubbed Bronze

# MOVARIO 70 NPT Side Shower 2 Sprays

MODEL # 28528

Pure Freude an Wasser



GROHE America, Inc | 200 North Gary Avenue, Suite G, Roselle, IL 60172  
Phone: +1 (800) 444-7643 | Fax: +1 (800) 225-2778 | us-customerservice@grohe.com

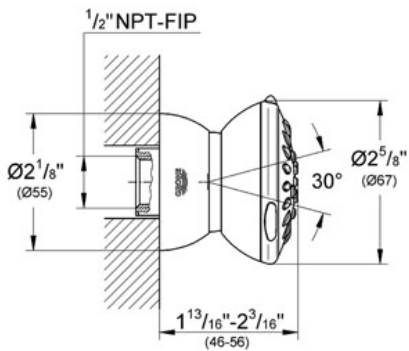

### Product Description: Side Shower 2 Sprays

#### Standard Specification:

- GROHE StarLight® finish
- SpeedClean anti-lime system
- GROHE EcoJoy® 2.4 g flow limiter
- Extreme low profile
- Ball-joint
- 1/2" NPT Female Threads
- 2 adjustable sprays: Wide Spray / Massage
- Max Flow Rate 2.5 gpm at 80 psi (9.5 L/min)

#### Applicable Codes & Standards:

- Energy Policy Act of 1992
- ASME A112.18.1/CSA B125.1

#### Color:

- 28528 000 chrome
- 28528 EN0 Brushed Nickel
- 28528 ZB0 Oil Rubbed Bronze
- 28528 BE0 Sterling inf

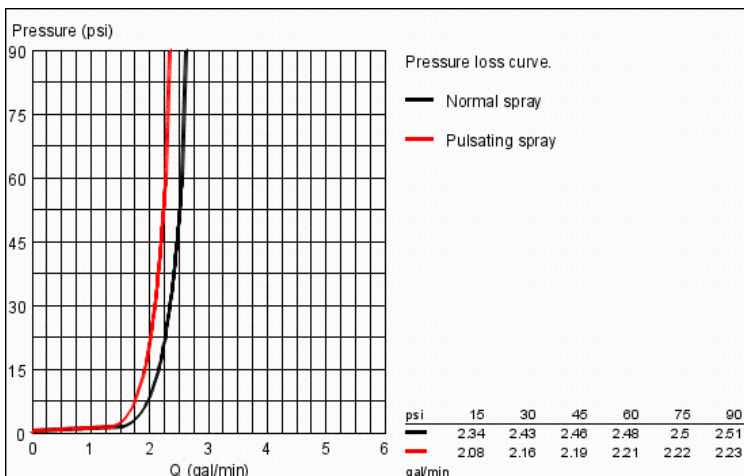

# NEW TEMPESTA 100 Shower rail set 4 sprays

MODEL # 28436

Pure Freude an Wasser



GROHE America, Inc | 200 North Gary Avenue, Suite G, Roselle, IL 60172  
Phone: +1 (800) 444-7643 | Fax: +1 (800) 225-2778 | us-customerservice@grohe.com

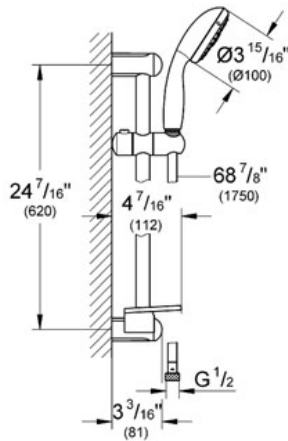

## Product Description: Shower rail set 4 sprays

### Standard Specification:

- GROHE StarLight® finish
- GROHE DreamSpray® perfect spray pattern
- GROHE EcoJoy® technology for less water and perfect flow
- SpeedClean anti-lime system
- Inner WaterGuide for a longer life
- Suitable for instantaneous heater
- Handshower (28 421 001)
- 24" shower bar (27 523 000)
- Relaxaflex 69" hose (28 154)
- GROHE EasyReach™ tray (27 596 000)
- ShockProof silicone ring prevents damages caused by shower falling
- Min. recommended pressure 15 psi
- Max Flow Rate 2.5 gpm (9.5 L/min)

### Applicable Codes & Standards:

- Energy Policy Act of 1992
- ASME A112.18.1/CSA B125.1

### Color:

- 28436 001 chrome
- 28436 EN1 Brushed Nickel inf

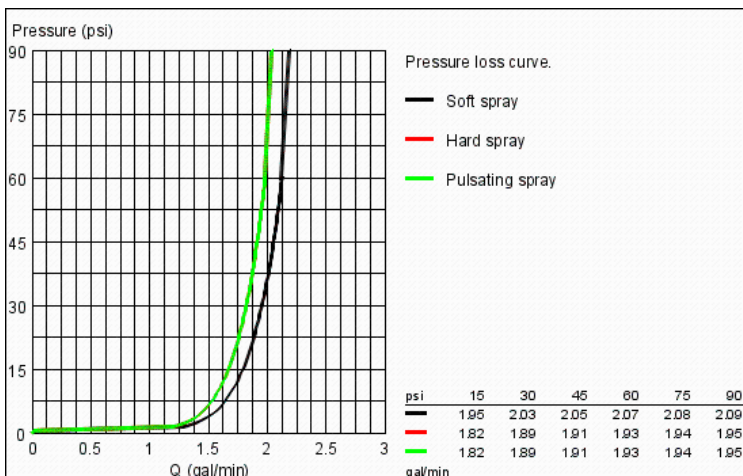

GROHFLEX™  
 Universal Rough-In Box  
 MODEL # 35026

Pure Freude an Wasser



GROHE America, Inc | 200 North Gary Avenue, Suite G, Roselle, IL 60172  
 Phone: +1 (800) 444-7643 | Fax: +1 (800) 225-2778 | us-customerservice@grohe.com

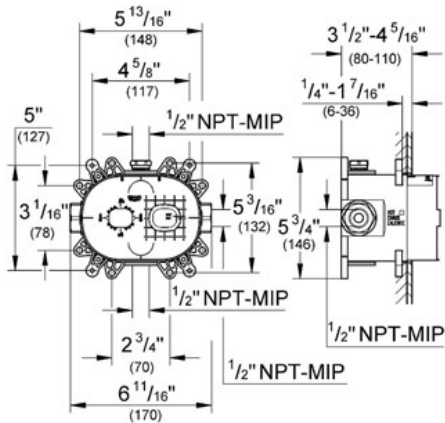
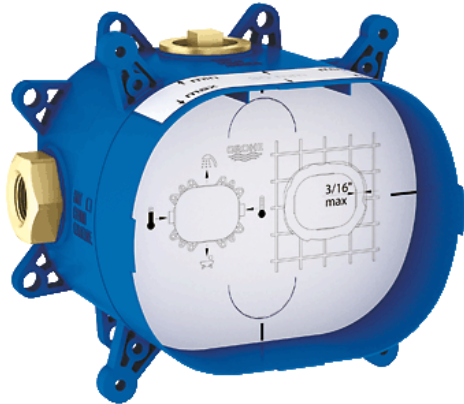

**Product Description:**  
 Universal Rough-In Box

**Standard Specification:**

- Inlets and outlets  $\frac{1}{2}''$
- Fixing points for front and back wall
- Leakproof housing
- Integrated service stops
- Flushing plug
- Removable protection cover with installation information
- For use with the GrohFlex Bathroom Solution Kits (sold separately):
  - Pressure Balance Valves and Thermostats
  - Single Function, Dual Function or Custom Shower

**Applicable Codes & Standards:**

- Energy Policy Act of 1992
- ASME A112.18.1/CSA B125.1

**Color:**

□ 35026 000

POWER&SOUL® 190

MODEL # 27767

Pure Freude an Wasser

GROHE

GROHE America, Inc | 200 North Gary Avenue, Suite G, Roselle, IL 60172  
Phone: +1 (800) 444-7643 | Fax: +1 (800) 225-2778 | us-customerservice@grohe.com

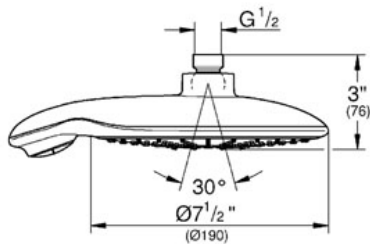

#### Product Description:

#### Standard Specification:

- GROHE StarLight® finish
- GROHE DreamSpray® perfect spray pattern
- SpeedClean anti-lime system
- GROHE EcoJoy® 2.4 g flow limiter
- GROHE Rain O2, Rain, Bokoma Spray®, Jet
- GROHE One-click showering spray selection via push button
- Suitable for instantaneous heater
- Min. recommended pressure 15 psi
- Max Flow Rate 2.5 gpm (9.5 L/min)

#### Applicable Codes & Standards:

- Energy Policy Act of 1992
- ASME A112.18.1/CSA B125.1

#### Color:

- 27767 000 chrome
- 27767 EN0 Brushed Nickel

# EUROPLUS

## Custom shower thermostatic trim with control module

MODEL # 19879

Pure Freude an Wasser



GROHE America, Inc | 200 North Gary Avenue, Suite G, Roselle, IL 60172  
 Phone: +1 (800) 444-7643 | Fax: +1 (800) 225-2778 | us-customerservice@grohe.com

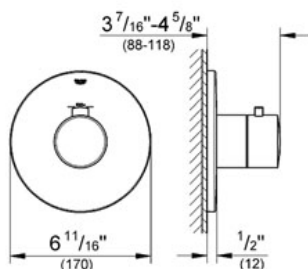

**Product Description:**  
 Custom shower thermostatic trim with control module

- Standard Specification:**
- GROHE StarLight® finish
  - GROHE TurboStat® technology
  - For high-flow, multiple outlet custom shower applications
  - Requires separate volume controls
  - For use with GrohFlex™ universal rough-in box 35 026 000 sold separately
  - Max Flow Rate: 14 gpm at 45 psi

- Applicable Codes & Standards:**
- Energy Policy Act of 1992
  - ASME A112.18.1/CSA B125.1
  - ICC/ANSI A117.1

- Color:**
- 19879 000 chrome
  - 19879 EN0 Brushed Nickel

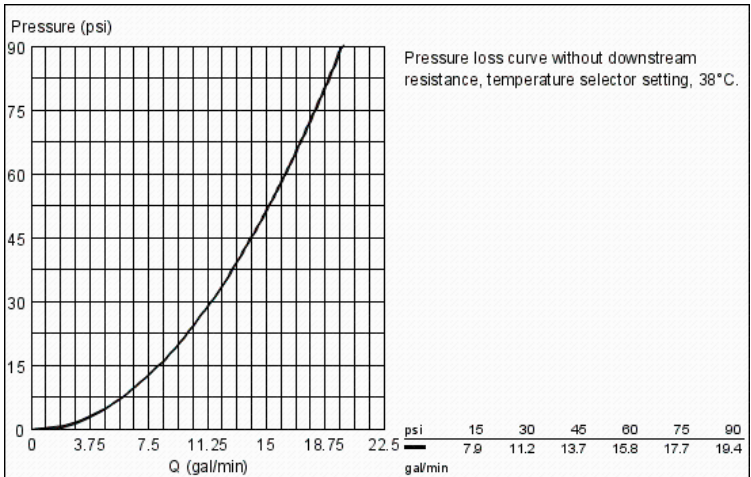

GENEVA  
Volume Control Trim  
MODEL # 19837

Pure Freude an Wasser



GROHE America, Inc | 200 North Gary Avenue, Suite G, Roselle, IL 60172  
Phone: +1 (800) 444-7643 | Fax: +1 (800) 225-2778 | us-customerservice@grohe.com

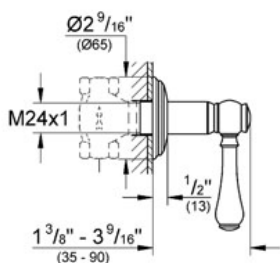

ADA

**Product Description:**  
Volume Control Trim

**Standard Specification:**

- GROHE StarLight® finish
- Lever handle
- Set for final installation for 29 273 (1/2" NPT) and 29 274 (3/4" NPT)

**Applicable Codes & Standards:**

- Energy Policy Act of 1992
- ASME A112.18.1/CSA B125.1
- ICC/ANSI A117.1

**Color:**

- 19837 000 chrome
- 19837 BE0 Sterling inf
- 19837 EN0 Brushed Nickel
- 19837 ZB0 Oil Rubbed Bronze

# Concealed stop-valve, 1/2"

MODEL # 29273

Pure Freude an Wasser



GROHE America, Inc | 200 North Gary Avenue, Suite G, Roselle, IL 60172  
Phone: +1 (800) 444-7643 | Fax: +1 (800) 225-2778 | us-customerservice@grohe.com

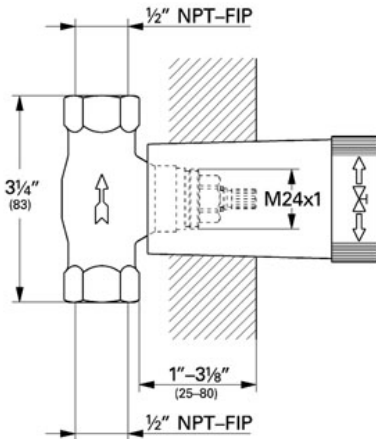

**Product Description:**  
Concealed stop-valve, 1/2"

**Standard Specification:**

- 1/2" Threaded union
- 1/2" NPT Male Threads

**Applicable Codes & Standards:**

- Energy Policy Act of 1992
- ASME A112.18.1/CSA B125.1

**Color:**  
 29273 000

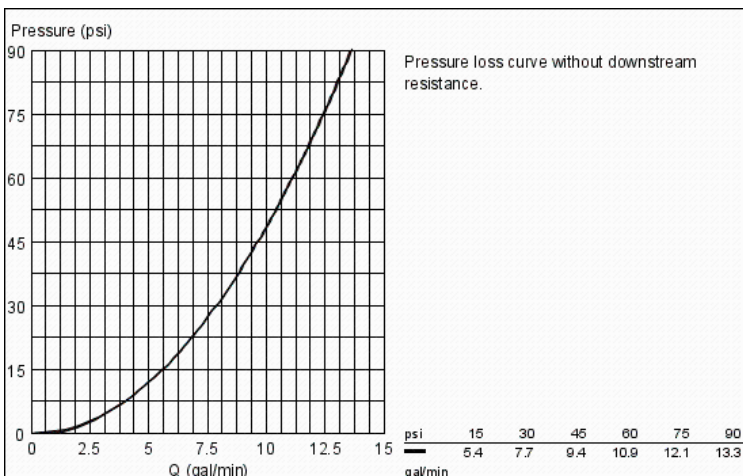



RELEXA  
Shower outlet elbow  
MODEL # 28627

*Pure Freude an Wasser*



GROHE America, Inc | 200 North Gary Avenue, Suite G, Roselle, IL 60172  
Phone: +1 (800) 444-7643 | Fax: +1 (800) 225-2778 | us-customerservice@grohe.com

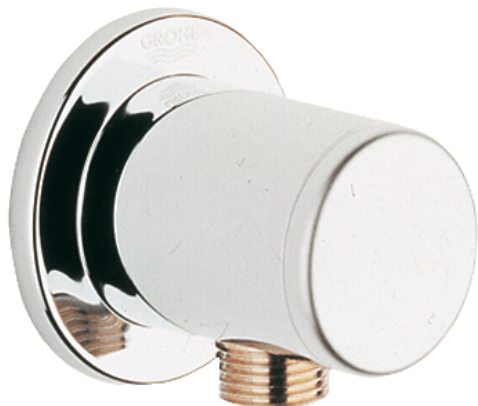

**Product Description:**  
Shower outlet elbow

**Standard Specification:**

- GROHE StarLight® finish
- 1/2" NPT Female Threads

**Applicable Codes & Standards:**

- Energy Policy Act of 1992
- ASME A112.18.1/CSA B125.1

**Color:**

- 28627 000 chrome
- 28627 EN0 Brushed Nickel

