

INSTALLATION INSTRUCTIONS

Fixture Name: AUTUMN TWILIGHT 9903-WSC MG

For Wall Mount Light Fixture

WARNING! SHUT POWER OFF AT FUSE OR CIRCUIT BREAKER

HANGING THE FIXTURE (Fig.1)

1. Carefully remove the new fixture from the carton and the yellow parts bag. Check that all parts are included as shown in the illustration and parts list.
2. Shut off power at the circuit breaker and remove the old fixture from wall, including the old mounting strap.
3. The Mounting Strap (A) contains several pairs of threaded holes, find the pair of holes that match the holes spacing in your fixture Back Plate (D) and thread the two Fixture Mounting Screws (C) half way into the Fixture Mounting Strap (A).
4. Place the Mounting Strap (A) over the Junction Box so the Fixture Mounting Screws (C) are vertical or horizontal, as required by the fixture type.
5. Attach the Fixture Mounting Strap (A) to the Junction Box using the two Mounting Screws (B). Tighten the Screws (B) securely with screwdriver.

Fig. 1

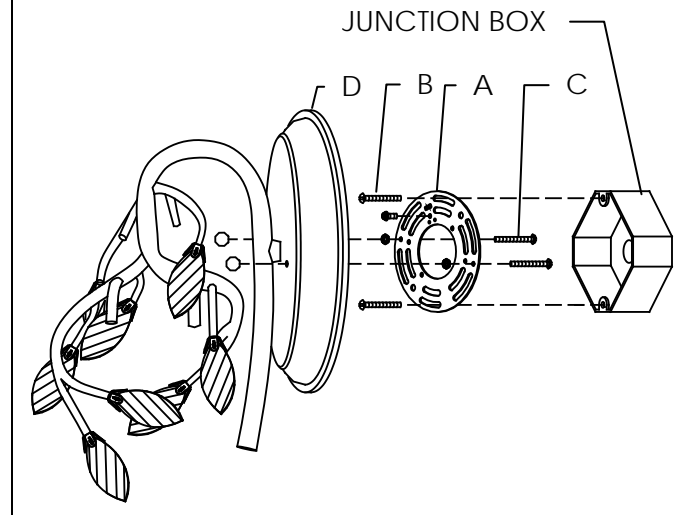

CONNECTING THE WIRES (Fig.2)

6. Attach the power supply wires to the fixture lead wires by connecting BLACK to BLACK (or SMOOTH) and WHITE to WHITE (or RIBBED).
7. Attach the GROUND wire (GREEN or COPPER) from the Junction Box and the fixture Ground wire to the green Ground Screw on the Mounting Bracket (B) or connect both wires together using the correct size of wire connectors.

NOTE: Twist the wires together in the same direction you twist the wire connector onto the wires.

8. Tuck these wire connections neatly into the Junction Box.

Fig.2

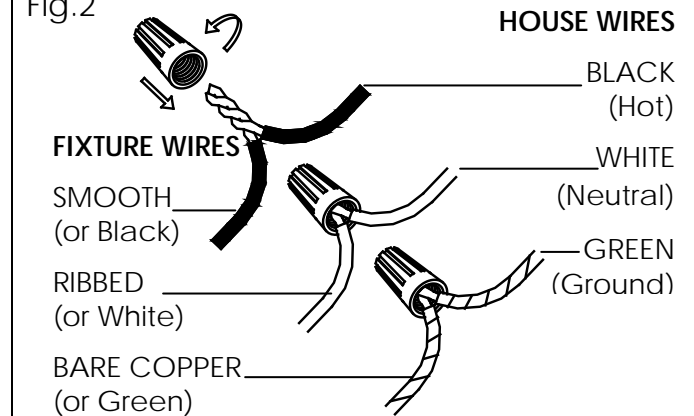

FINISHING THE INSTALLATION (Fig.3)

9. After tucking these wire connections neatly into the Junction Box and place the fixture Back Plate (D) over the two Mounting Screws (C) and secure the Back Plate (D) against the wall by threading two Deco Nuts (E) over the two Mounting Screws (C) until tight as shown on Fig.3.
10. Install crystals as per the fixture assembly instructions.

YOUR INSTALLATION IS NOW COMPLETE. RETURN POWER TO THE JUNCTION BOX AND TEST THE FIXTURE.

Fig.3

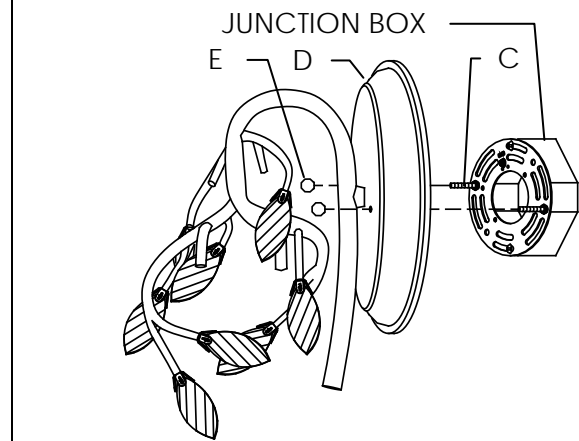

PARTS & ASSEMBLY SHEET









Fixture Name: AUTUMN TWILIGHT 9903-WSC MG

This fixture assembled PO: _____ Date: _____

Notice: Please review the parts listing and check for all parts before assembling the fixture. If any parts are missing or damaged, please note on this sheet and contact the place of purchase to arrange for replacement parts.

PARTS LIST

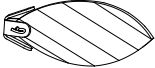
Company Name: _____ Co Account#: _____
below to be filled out by retailer

Mounting Strap Φ102 mm 1ea		Green Screw G8/32*H8 mm 1ea		Mounting Screws H32 mm 2ea H38 mm 2ea	
Wire Connectors Orange 3ea		Hex Nut G5/32*H4 mm 2ea		Deco Nut Φ12 mm 2ea	
Crystal Leaf PT-CRYSTAL-9903 LEAF 8ea W27*H65 mm		Bulbs 3ea Halogen, Type G4 20W			

Part Needed _____ Quantity _____

Part Needed _____ Quantity _____

Reason why (missing, scratched, broken glass, bent, bad finish)

Comments _____

FIXTURE ASSEMBLY INSTRUCTIONS

Read and review installation instruction sheet before assembling the fixture

1. Open bag on the arm and carefully arrange the bead strings.
2. Screw Crystal Leaf (A) on the arm.
3. Install the light bulbs in accordance with the fixture's specification.

Bulb note: Use a tissue or paper towel to hold the bulb and push down into socket. Oils or dirt can cause the bulb life to shorten. Rubbing alcohol is recommended to clean the bulbs if dirty.

(DO NOT EXCEED THE MAXIMUM WATTAGE RATING!)

NOTE: INSTALL THE GLASS ASSEMBLY AFTER FIXTURE IS HUNG.

9903-WSC MG

Fig.1

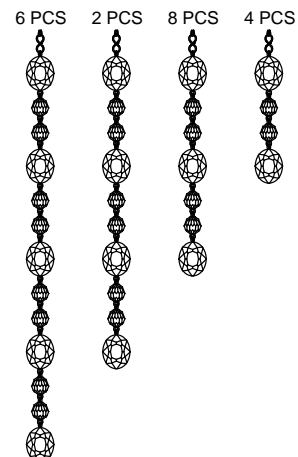
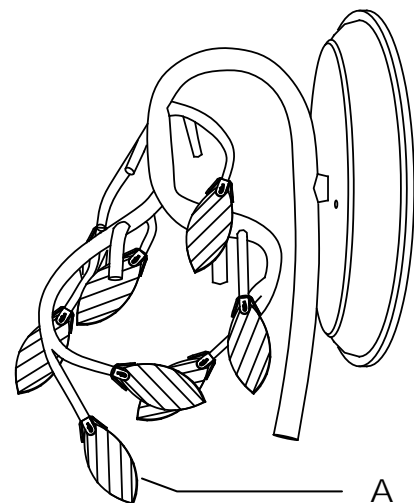

9903-WSC MG

- A -- PT-CRYSTAL-9903-2B
- B -- PT-CRYSTAL-9903-3B
- C -- PT-CRYSTAL-9903-4B
- D -- PT-CRYSTAL-9903-5B

Required

A

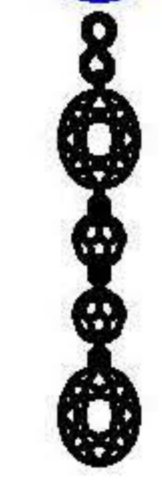

B

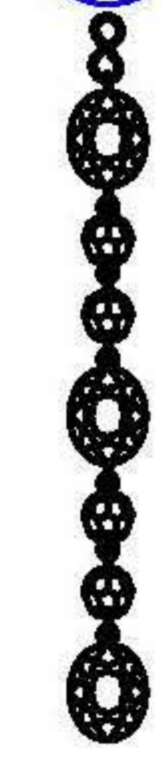

C

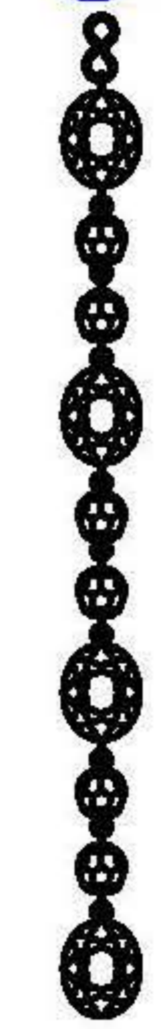

D

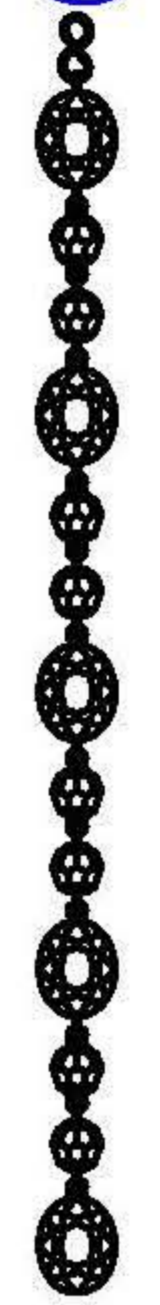

X4

X8

X2

X6

