











Fixture Name: Presilla 9363-5 GMT

This fixture assembled PO: \_\_\_\_\_ Date: \_\_\_\_\_

**Notice:** Please review the parts listing and check for all parts before assembling the fixture. If any parts are missing or damaged, please note on this sheet and contact the place of purchase to arrange for replacement parts.

## PARTS LIST

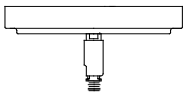
Company Name: \_\_\_\_\_ Co. Account #: \_\_\_\_\_  
to be filled out by retailer

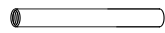
<b>Mounting Strap</b>  1ea L104*W24*H11mm	<b>Mounting screw</b>  2ea 8/32-IP*H1"	<b>Mounting screw</b>  2ea 5/32-IP*H1-1/2"
<b>Hex nut</b>  2ea 5/32-IP*H3mm	<b>Wire connector</b>  3 ea A3 Orange	<b>Finial</b>  2ea 3/8-IP*H9mm
<b>Metal ring</b>  1ea $\phi$ 124*H8mm	<b>U Iron Clip (PT-OSRING 9363)</b>  5ea L101*W70*H68mm	<b>Canopy</b>  1ea $\phi$ 130Dia*H63.5mm
<b>Rod</b>  3ea 12.7mmDia* H12"	<b>Rod</b>  1ea 12.7mmDia* H6"	

Part Needed _____	Quantity _____
Part Needed _____	Quantity _____
Reason why (missing, scratched, broken glass, bent, bad finish) _____	
Comments _____	

### FIXTURE ASSEMBLY INSTRUCTIONS

Read and review installation instruction sheet, but do not install before assembling the fixture.

1. By measuring determine correct number of rods needed for proper hanging height.

\* This fixture includes 4 rods (6", 12", 12", 12")

2. To shorten the fixture; slide the excess rods off the wires. To lengthen add additional rods.

**NOTE: INSTALL THE GLASS ASSEMBLY AFTER THE FIXTURE IS HUNG.**

9363-5 GMT

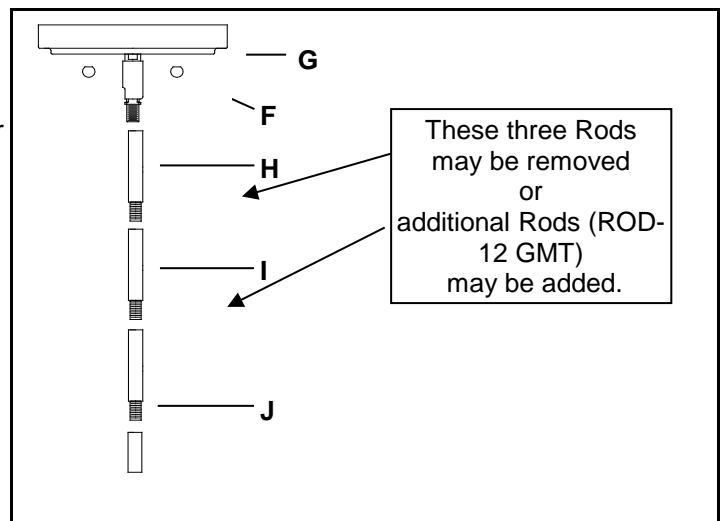

For Customer Service, contact the place of purchase to arrange for replacement parts.

# PARTS & ASSEMBLY SHEET continued

Fixture Name: Presilla 9363-5 GMT

3. Pull the fixture's wire through the Rods.
4. Thread Rod (J) into Frame (K) until tight.
5. Thread Rod (I) into Rod (J) until tight. repeat for any additional rods.
6. Feed the fixture wires through the Canopy (G) and pull the wires until taut.
7. Thread Canopy (G) into Rod (H) until tight.

\* You may now install the fixture.

Note: Complete these remaining steps after the fixture is hung.

8. Place the U Iron Clip (N)"OSRING" over the Socket (O).
9. Slide the Glass Shade (L) over Socket (O) and secure it by threading the White Ring(M-1) and Socket Ring (M) onto the Threaded Socket (O) until tight.
10. Place the Metal ring (Q) onto the small nipple (P) on the inner side of the fixture frame. The fixture arms can be adjusted to their correct positions to meet these points.
11. Install the light bulbs in accordance with the fixture's specification.

(DO NOT EXCEED MAXIMUM WATTAGE RATING!)

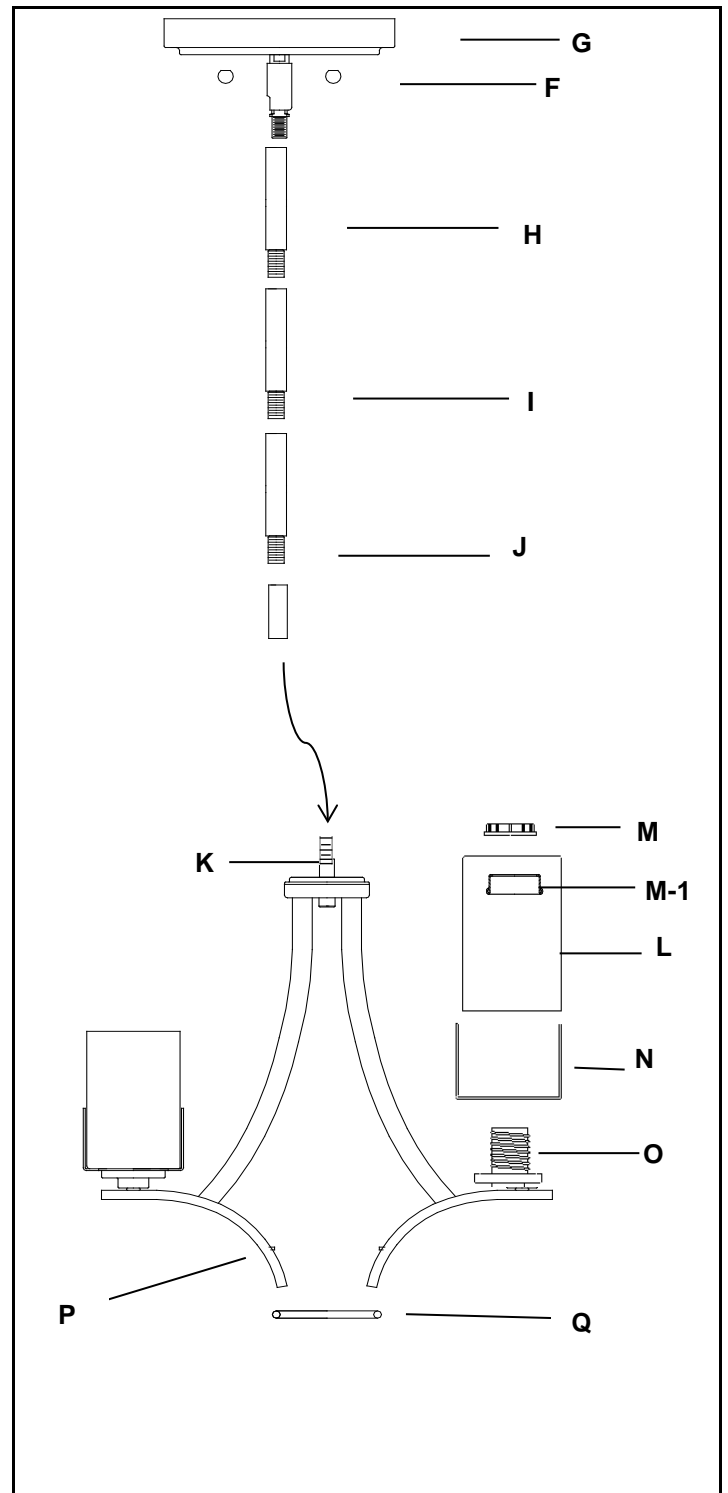

For Customer Service, contact the place of purchase to arrange for replacement parts.

## WARNING! SHUT OFF POWER AT FUSE OR CIRCUIT BREAKER.

### HANGING THE FIXTURE (Fig. 1)

1. Carefully remove the new fixture from the carton and the yellow bag that holds all your parts. Check that all parts are included as shown in the illustration and parts list.
2. Shut off power at the circuit breaker and remove the old fixture from ceiling, including the old mounting strap.
3. The Mounting Strap (B) contains several pairs of threaded holes, find the pair of holes that match the hole spacing in your fixture Canopy (G) and thread the two Mounting Screws (C) into the Mounting Strap (B) facing down, Secure in place with hex nuts. These will have their threaded ends protrude through the two holes in the fixture canopy (G).
4. Place the Mounting Strap (B) over the junction
5. Attach the Mounting Strap (B) to the Junction Box using the two mounting screws (A). Tighten the screws (B) securely with screw driver.

Fig. 1

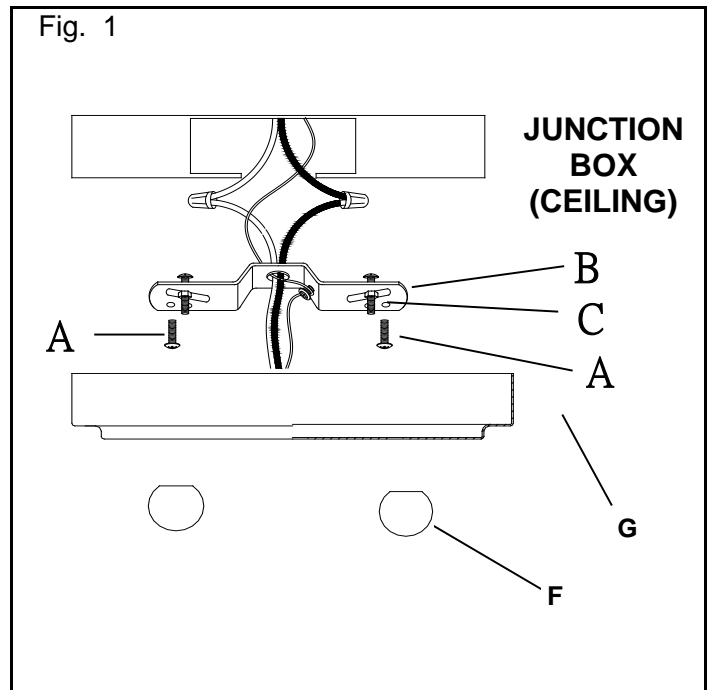

### CONNECTING THE WIRES (Fig. 2)

6. Attach the power supply wires to the fixture lead wires by connecting BLACK to BLACK (or SMOOTH) and WHITE to WHITE (or RIBBED).
  7. Attach the GROUND wire (GREEN or COPPER) from the Junction Box and the fixture Ground wire to the green Ground Screw on the Mounting Bracket (B) or connect both wires together using the correct size of wire connectors.
- NOTE: Twist the wires together in the same direction you twist the wire connector onto the wires.
8. Tuck these wire connections neatly into the Junction Box.

Fig. 2

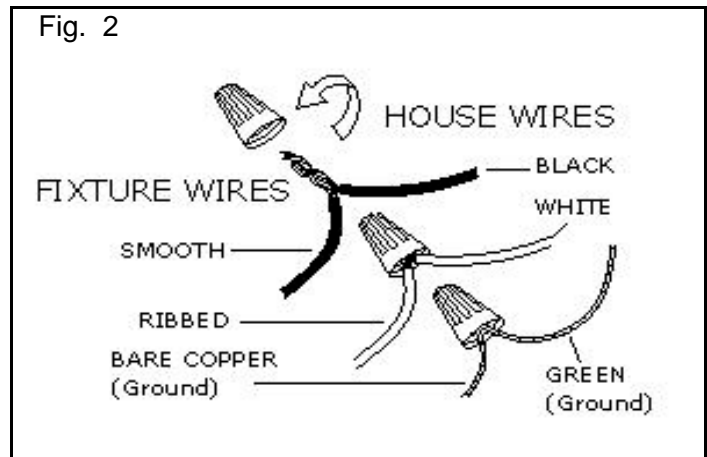

### FINISHING THE INSTALLATION (Fig. 3)

9. Place the fixture's canopy over the Mounting Strap (B) and over the Mounting Screws (C), adjust the fixture Canopy (G) until the Mounting Screws (C) protrude out from the Canopy (G) and secure the fixture against the ceiling by threading the Decorative nuts (F) until tight.

YOUR INSTALLATION IS NOW COMPLETE. RETURN POWER TO THE JUNCTION BOX AND TEST THE FIXTURE.

Fig. 3

