



# Built-In Electric Wall Oven

*Safety Instructions* .....2-4

*Operating Instructions*

Clock and Timer .....8  
Oven .....5-14  
Sabbath Feature .....12  
Self-Cleaning .....14  
Special Features .....10, 11  
Thermostat .....13  
Timed Baking and  
Roasting .....9

*Care and Cleaning*

Control Panel .....16  
Door .....15  
Glass Surfaces .....16  
Heating Element .....16  
Knob .....16  
Lift-Off Oven Door .....15  
Light .....17  
Oven Interior .....17  
Painted Surfaces .....16  
Racks .....16  
Stainless Steel Surfaces .....16

*Troubleshooting Tips* ...18-20

*Consumer Support*

Accessories .....21  
Consumer Support... Back Cover  
Warranty .....23

**Write the model and serial numbers here:**

**Model #** \_\_\_\_\_

**Serial #** \_\_\_\_\_

You can find them on a label on the front of the lower oven behind the oven door.

**Owner's Manual**

JRP20  
JRP28  
JRS06

## IMPORTANT SAFETY INFORMATION. READ ALL INSTRUCTIONS BEFORE USING.

### **⚠ WARNING!**

For your safety, the information in this manual must be followed to minimize the risk of fire or explosion, electric shock, or to prevent property damage, personal injury, or loss of life.



### IMPORTANT SAFETY NOTICE

The California Safe Drinking Water and Toxic Enforcement Act requires the Governor of California to publish a list of substances known to the state to cause cancer, birth defects or other reproductive harm, and requires businesses to warn customers of potential exposure to such substances.

The fiberglass insulation in self-clean ovens gives off a very small amount of carbon monoxide during the cleaning cycle. Exposure can be minimized by venting with an open window or using a ventilation fan or hood.

**⚠ IMPORTANT:** The health of some birds is extremely sensitive to the fumes given off during the self-cleaning cycle of any oven. Move birds to another well ventilated room.

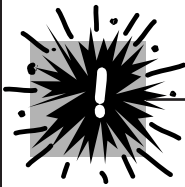

### SAFETY PRECAUTIONS

When using electrical appliances, basic safety precautions should be followed, including the following:

- Use this appliance only for its intended purpose as described in this Owner's Manual.
- Be sure your appliance is properly installed and grounded by a qualified technician in accordance with the provided installation instructions.
- Do not attempt to repair or replace any part of your oven unless it is specifically recommended in this manual. All other servicing should be referred to a qualified technician.
- Have the installer show you the location of the circuit breaker or fuse. Mark it for easy reference.
- Before performing any service, disconnect the oven power supply at the household distribution panel by removing the fuse or switching off the circuit breaker.
- Do not leave children alone—children should not be left alone or unattended in an area where an appliance is in use. They should never be allowed to sit or stand on any part of the appliance.
- Do not allow anyone to climb, stand or hang on the door. They could damage the oven, or cause severe personal injury.
- Be sure the oven is securely installed in a cabinet that is firmly attached to the house structure. Never allow anyone to climb, sit, stand or hang on the oven door.
- Never leave the oven door open when you are not watching the oven.
- Always keep combustible wall covering, curtains or drapes a safe distance from your oven.
- Always keep dish towels, dish cloths, pot holders and other linens a safe distance from your oven.
- Always keep wooden and plastic utensils and canned food a safe distance away from your oven.
- Teach children not to play with the controls or any other part of the oven.
- Large scratches or impacts to glass doors can lead to broken or shattered glass.

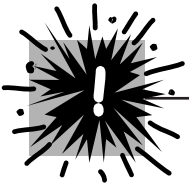

## **⚠ WARNING!** SAFETY PRECAUTIONS

- Do not store flammable materials in an oven.
  - **⚠ CAUTION:** Items of interest to children should not be stored in cabinets above an oven; children climbing on the oven to reach items could be seriously injured.
  - Never wear loose-fitting or hanging garments while using the appliance. Be careful when reaching for items stored in cabinets over the oven. Flammable material could be ignited if brought in contact with hot surfaces or heating elements and may cause severe burns.
  - Use only dry pot holders—moist or damp pot holders on hot surfaces may result in burns from steam. Do not let pot holders touch hot heating elements. Do not use a towel or other bulky cloth.
  - For your safety, never use your appliance for warming or heating the room.
  - Do not let cooking grease or other flammable materials accumulate in or near the oven.
  - Do not use water on grease fires. Never pick up a flaming pan. Turn the controls off.  
  
Flame in the oven can be smothered completely by closing the oven door and turning the oven off or by using a multi-purpose dry chemical or foam-type fire extinguisher.
  - Never leave jars or cans of fat drippings in or near your oven.
  - Do not store or use combustible materials, gasoline or other flammable vapors and liquids in the vicinity of this or any other appliance.
  - Stand away from the oven when opening the oven door. Hot air or steam which escapes can cause burns to hands, face and/or eyes.
  - Do not heat unopened food containers. Pressure could build up and the container could burst, causing an injury.
  - Keep the oven vent unobstructed.
  - Keep the oven free from grease buildup.
  - Place the oven rack in the desired position while the oven is cool. If racks must be handled when hot, do not let pot holder contact the heating elements.
  - When using cooking or roasting bags in the oven, follow the manufacturer's directions.
  - Do not touch the heating elements or the interior surface of the oven. These surfaces may be hot enough to burn even though they are dark in color. During and after use, do not touch, or let clothing or other flammable materials contact any interior area of the oven; allow sufficient time for cooling first.  
  
Potentially hot surfaces include oven vent openings, surfaces near the openings, crevices around the oven door, the edges of the window and metal trim parts above the door.
- REMEMBER:** The inside surface of the oven may be hot when the door is opened.

## **IMPORTANT SAFETY INFORMATION. READ ALL INSTRUCTIONS BEFORE USING.**



### **⚠ WARNING!** **SAFETY PRECAUTIONS**

- Pulling out the rack to the stop-lock is a convenience in lifting heavy foods. It is also a precaution against burns from touching hot surfaces of the door or oven walls.
- Do not use the oven to dry newspapers. If overheated, they can catch on fire.
- Do not use the oven for a storage area. Items stored in an oven can ignite.
- Do not leave paper products, cooking utensils or food in the oven when not in use.
- After broiling, always take any broiler pan out of the oven and clean it. Leftover grease in a broiler pan can catch fire next time you use the pan.
- Clean only parts listed in this Owner's Manual.
- Do not use aluminum foil to line oven bottoms. Improper installation of aluminum foil may result in a risk of electric shock or fire.



### **COOK MEAT AND POULTRY THOROUGHLY...**

*Cook meat and poultry thoroughly—meat to at least an INTERNAL temperature of 160°F and poultry to at least an INTERNAL temperature of 180°F. Cooking to these temperatures usually protects against foodborne illness.*

### **SELF-CLEANING OVEN (on some models)**

- Do not clean the door gasket. The door gasket is essential for a good seal. Care should be taken not to rub, damage or move the gasket.
- Do not use oven cleaners. No commercial oven cleaner or oven liner protective coating of any kind should be used in or around any part of the oven. Residue from oven cleaners will damage the inside of the oven when the self-clean cycle is used.
- Before self-cleaning the oven, remove shiny, silver-colored oven racks (on some models) and all other cookware.
- Be sure to wipe up excess spillage before starting the self-cleaning operation.
- If the self-cleaning mode malfunctions, turn the oven off and disconnect the power supply. Have it serviced by a qualified technician.



### **READ AND FOLLOW THIS SAFETY INFORMATION CAREFULLY. SAVE THESE INSTRUCTIONS**

Throughout this manual, features and appearance may vary from your model.

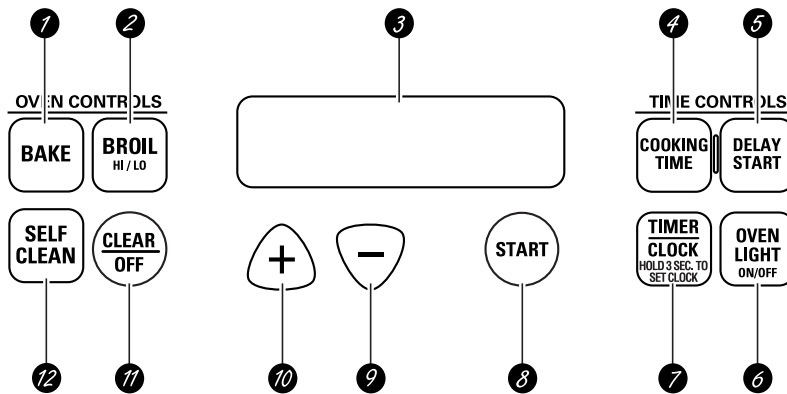

## Upper Oven Control, Clock and Timer Features and Settings



- 1 BAKE Pad**  
Touch this pad to select the bake function.  
**BAKE Light**  
Flashes while in edit mode—you can change the oven temperature at this point. Glows when the oven is in bake mode.
- 2 BROIL HI/LO Pad**  
Touch this pad to select the broil function.  
**BROIL Light**  
Flashes while in edit mode—you can switch from **HI** to **LO BROIL** at this point. Glows when the oven is in broil mode.
- 3 Display**  
Shows the operations you have selected, the time of day and the cooking status.
- 4 COOKING TIME Pad**  
Touch this pad and then touch the **+** or **-** pad to set the amount of time you want your food to cook. The oven will shut off when the cooking time has run out.
- 5 DELAY START Pad**  
Use along with the **COOKING TIME** or **SELF CLEAN** pad to set the oven to start and stop automatically at a time you set.
- 6 OVEN LIGHT ON/OFF Pad**  
Touch this pad to turn the oven light on or off.
- 7 TIMER/CLOCK Pad**  
Touch this pad to select the timer feature. Then touch **+** and **-** pads to adjust time.  
To set the clock, touch this pad twice and hold 3 seconds and then touch the **+** and **-** pads. The time of day will flash in the display when the oven is first turned on.
- 8 START Pad**  
Must be touched to start any cooking function.
- 9 - Pad**  
Short taps to this pad will decrease the time or temperature by small amounts. Touch and hold the pad to decrease the time or temperature by larger amounts.
- 10 + Pad**  
Short taps to this pad will increase the time or temperature by small amounts. Touch and hold the pad to increase the time or temperature by larger amounts.
- 11 CLEAR/OFF Pad**  
Touch this pad to cancel **ALL** oven operations except the clock and timer.
- 12 SELF CLEAN Pad (on some models)**  
Touch this pad to select the self-cleaning function. See the *Using the self-cleaning oven* section.  
**CLEAN Light**  
Flashes while in edit mode—you can change the length of time for the self-clean cycle at this point. Glows when the oven is in the self-clean cycle. After the self-clean cycle, the light will turn off. Unlatch the door.  
*If "F- and a number or letter" flash in the display and the oven control signals, this indicates a function error code. Touch the CLEAR/OFF pad. Allow the oven to cool for one hour. Put the oven back into operation. If function error code repeats, disconnect power to the oven and call for service.*

## Lower Oven Control (on some models)

**OVEN TEMP Knob**  
Turn this knob to the temperature setting you want.

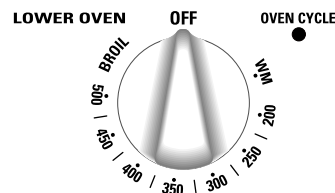

The **OVEN CYCLE** light glows until the oven reaches your selected temperature, then goes off and on with the oven element(s) during cooking.

## Using the oven.

To avoid possible burns, place the racks in the desired position before you turn the oven on.

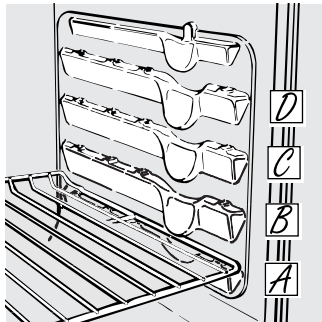

The oven has 4 rack positions.

### Before you begin...

The racks have stop-locks, so that when placed correctly on the supports, they will stop before coming completely out, and will not tilt.

When placing and removing cookware, pull the rack out to the bump on the rack support.

**To remove a rack**, pull it toward you, tilt the front end up and pull it out.

**To replace**, place the end of the rack (stop-locks) on the support, tilt up the front and push the rack in.

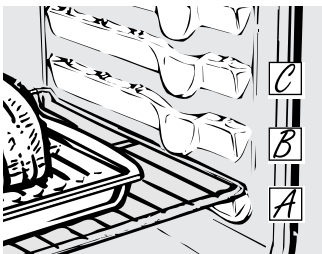

### How to Set the Oven for Baking or Roasting

- 1 Touch the **BAKE** pad.
- 2 Touch the **+** or **-** pad to set the desired temperature.
- 3 Touch the **START** pad.
- 4 Check food for doneness at minimum time on recipe. Cook longer if necessary.
- 5 Touch the **CLEAR/OFF** pad when cooking is complete.

**NOTE:** The lower oven is controlled with a knob. To set the oven for baking turn the knob to the desired setting or temperature. Turn the knob to OFF when baking is complete.

Type of Food	Rack Position
Frozen pies (on cookie sheet)	B or C
Angel food cake, bundt or pound cakes	A
Biscuits, muffins, brownies, cookies, cupcakes, layer cakes, pies	B or C
Casseroles	B or C
Roasting	A or B

**NOTE:** A cooling fan may automatically turn on and off to cool internal parts. This is normal, and the fan may continue to run even after the oven is turned off.

### Preheating and Pan Placement

Preheat the oven if the recipe calls for it. To preheat, set the oven at the correct temperature. Preheating is necessary for good results when baking cakes, cookies, pastry and breads.

For ovens without a preheat indicator light or tone, preheat 10 minutes.

Baking results will be better if baking pans are centered in the oven as much as possible. Pans should not touch each other or the walls of the oven. If you need to use two racks, stagger the pans so one is not directly above the other, and leave approximately 1½" between pans, from the front, back and sides of the wall.

### Aluminum Foil

Do not use aluminum foil on the bottom of the oven.

Never entirely cover a rack with aluminum foil. This will disturb the heat circulation and result in poor baking.

A smaller sheet of foil may be used to catch a spillover by placing it on a lower rack several inches below the food.



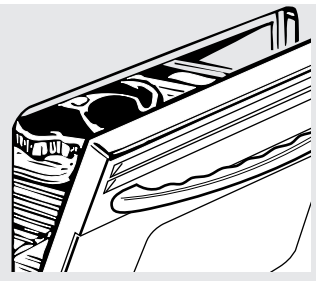

Leave the door open to the broil stop position. The door stays open by itself, yet the proper temperature is maintained in the oven.

### How to Set the Oven for Broiling

- 1 Place the meat or fish on a broiler grid in a broiler pan designed for broiling.
- 2 Follow suggested rack positions in the *Broiling Guide*.
- 3 Touch the **BROIL HI/LO** pad once for **HI Broil**.  
To change to **LO Broil**, touch the **BROIL HI/LO** pad again.
- 4 Touch the **START** pad.
- 5 When broiling is finished, touch the **CLEAR/OFF** pad.

If your oven is connected to 208 volts, rare steaks may be broiled by preheating the broiler and positioning the oven rack one position higher.

**NOTE:** The lower oven is controlled with a knob. To set the oven for broiling turn the knob to **BROIL**. Turn the knob to **OFF** when broiling is complete.

### Broiling Guide

Food	Quantity and/ or Thickness	Rack Position	First Side Time (min.)	Second Side Time (min.)	Comments
<b>Ground Beef</b> Well Done	1 lb. (4 patties) 1/2 to 3/4" thick	C	10	7	Space evenly. Up to 8 patties take about the same time.
<b>Beef Steaks</b> Rare Medium Well Done	1" thick 1 to 1 1/2 lbs.	C C C	6 8 12	5 6 11	Steaks less than 1" thick cook through before browning. Pan frying is recommended. Slash fat.
Rare Medium Well Done	1 1/2" thick 2 to 2 1/2 lbs.	C C C	10 15 25	7-8 14-16 20-25	
<b>Chicken</b>	1 whole 2 to 2 1/2 lbs., split lengthwise	A	35	10-15	Reduce time about 5 to 10 minutes per side for cut-up chicken. Brush each side with melted butter. Broil skin-side-down first.
<b>Loxster Tails</b>	2-4 6 to 8 oz. each	B	13-16	Do not turn over.	Cut through back of shell. Spread open. Brush with melted butter before broiling and after half of broiling time.
<b>Fish Fillets</b>	1/4 to 1/2" thick	C	5	5	Handle and turn very carefully. Brush with lemon butter before and during cooking, if desired. Preheat broiler to increase browning.
<b>Ham Slices</b> (precooked)	1" thick	B	8	8	Increase time 5 to 10 minutes per side for 1 1/2" thick or home-cured ham.
<b>Pork Chops</b> Well Done	2 (1/2" thick) 2 (1" thick) about 1 lb.	C B	10 13	10 13	Slash fat.
<b>Lamb Chops</b> Medium Well Done Medium Well Done	2 (1" thick) about 10 to 12 oz. 2 (1 1/2" thick) about 1 lb.	C C C B	10 12 14 17	9 10 12 12-14	Slash fat.

## Using the clock and timer.

Not all features are on all models.

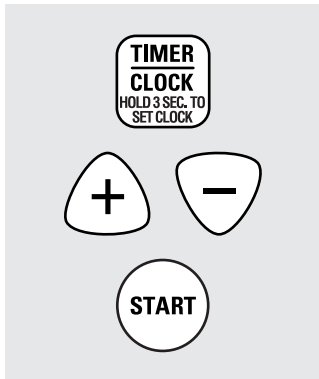

Make sure the clock is set to the correct time of day.

### To Set the Clock

The clock must be set to the correct time of day for the automatic oven timing functions to work properly. The time of day cannot be changed during a delayed cooking or a delayed self-cleaning cycle.

- 1 Touch the **TIMER/CLOCK** pad twice.
- 2 Touch the **+** or **-** pad.

If the **+** or **-** pad is not touched within one minute after you touch the **TIMER/CLOCK** pad, the display reverts to

the original setting. If this happens, touch the **TIMER/CLOCK** pad twice and reenter the time of day.

- 3 Touch the **START** pad until the time of day shows in the display. This enters the time and starts the clock.

To check the time of day when the display is showing other information, simply touch the **TIMER/CLOCK** pad. The time of day shows until another pad is touched.

### To Turn Off the Clock Display

If you have several clocks in your kitchen, you may wish to turn off the time of day clock display on your oven.

- 1 Touch the **TIMER/CLOCK** pad once to turn off the time of day display. Although you will not be able to

see it, the clock maintains the correct time of day.

- 2 Touch the **TIMER/CLOCK** pad twice to recall the clock display.

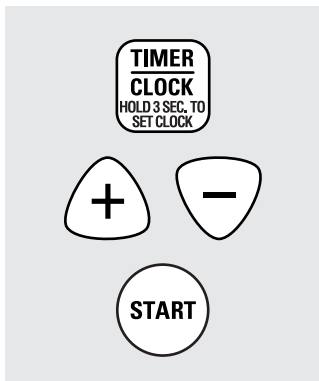

The timer is a minute timer only.

The **CLEAR/OFF** pad does not affect the timer.

### To Set the Timer

The timer does not control oven operations. The maximum setting on the timer is 9 hours and 59 minutes.

- 1 Touch the **TIMER/CLOCK** pad.
- 2 Touch the **+** or **-** pad until the amount of time you want shows in the display. The maximum time that can be entered in minutes is 59. Times more than 59 minutes should be changed to hours and minutes.

If you make a mistake, touch the **TIMER/CLOCK** pad and begin again.

- 3 Touch the **START** pad. The time will start counting down, although the display does not change until one minute has passed.
- 4 When the timer reaches **:00**, the control will beep 3 times followed by one beep every 6 seconds until the **TIMER/CLOCK** pad is touched.

### To Reset the Timer

If the display is still showing the time remaining, you may change it by touching the **TIMER/CLOCK** pad, then touching the **+** or **-** pad until the time you want appears in the display.

If the remaining time is not in the display (clock, start time or cooking time are in the display), recall the remaining time by touching the **TIMER/CLOCK** pad and then touching the **+** or **-** pad to enter the new time you want.

### To Cancel the Timer

Touch the **TIMER/CLOCK** pad twice.



# Using the timed baking and roasting features.

(These features are not available for the lower oven.) (on some models)

GEAppliances.com

**NOTE:** Foods that spoil easily—such as milk, eggs, fish, stuffings, poultry and pork—should not be allowed to sit for more than 1 hour before or after cooking. Room temperature promotes the growth of harmful bacteria. Be sure that the oven light is off because heat from the bulb will speed harmful bacteria growth.

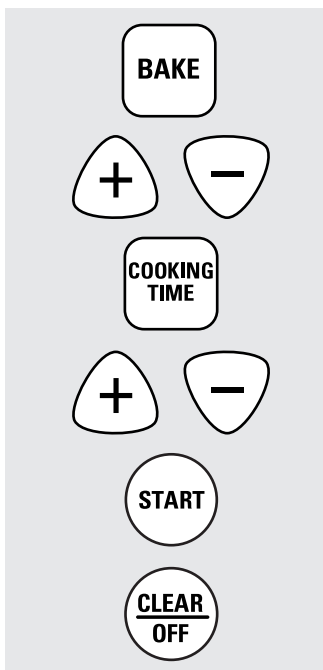

## How to Set an Immediate Start and Automatic Stop

The oven will turn on immediately and cook for a selected length of time. At the end of the cooking time the oven will turn off automatically.

Make sure the clock shows the correct time of day.

- 1 Touch the **BAKE** pad.
- 2 Using the **+** or **-** pad, enter the desired temperature.
- 3 Touch the **COOKING TIME** pad.

**NOTE:** If your recipe requires preheating, you may need to add additional time to the length of the cooking time.

- 4 Using the **+** or **-** pad, enter the desired baking time. The maximum time you can enter in minutes is 59. Cooking times more than 59 minutes should be changed

to hours and minutes. For example, enter 90 minutes as 1 hour, 30 minutes.

The oven temperature and the cooking time that you entered will be displayed.

- 5 Touch the **START** pad.

The display shows the oven temperature that you set and the cooking time countdown. The display starts changing once the temperature reaches 100°F.

The oven will continue to cook for the programmed amount of time, then shut off automatically, unless the Cook and Hold feature was set. See the *Special features of your oven control* section.

Touch the **CLEAR/OFF** pad to clear the display.

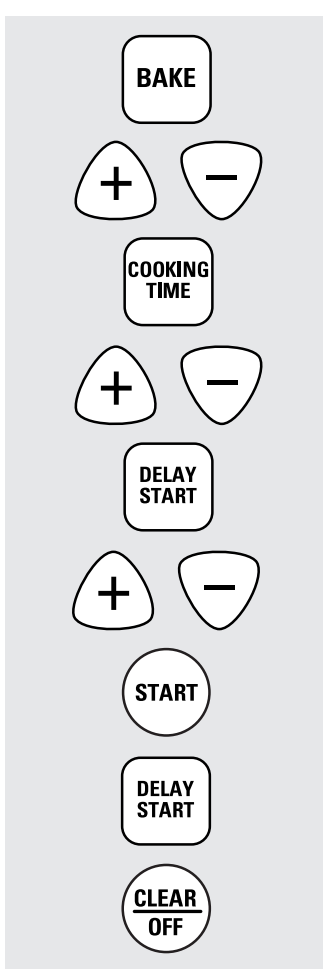

## How to Set a Delayed Start and Automatic Stop

You can set the oven control to delay-start the oven, cook for a specific length of time and then turn off automatically.

Make sure the clock shows the correct time of day.

- 1 Touch the **BAKE** pad.
- 2 Using the **+** or **-** pad, enter the desired temperature.
- 3 Touch the **COOKING TIME** pad.

**NOTE:** If your recipe requires preheating, you may need to add additional time to the length of the cooking time.

- 4 Using the **+** or **-** pad, enter the desired baking time. The maximum time you can enter in minutes is 59. Cooking times more than 59 minutes should be changed to hours and minutes. For example, enter 90 minutes as 1 hour, 30 minutes.

The oven temperature and the cooking time that you entered will be displayed.

- 5 Touch the **DELAY START** pad.
- 6 Using the **+** or **-** pad, enter the time of day you want the oven to turn on and start cooking.
- 7 Touch the **START** pad.

**NOTE:** An attention tone will sound if you are using timed baking and do not touch the **START** pad after entering the baking temperature.

If you would like to check the times you have set, touch the **DELAY START** pad to check the start time you have set, or touch the **COOKING TIME** pad to check the length of cooking time you have set.

When the oven turns on at the time of day you have set, the display will show the changing temperature (starting at 100°F) and the cooking time countdown.

The oven will continue to cook for the programmed amount of time, then shut off automatically, unless the Cook and Hold feature was set. See the *Special features of your oven control* section.

At the end of timed baking, the oven will turn off. The end of cycle tone will sound.

Touch the **CLEAR/OFF** pad to clear the display.

## Special features of your oven control.

Your new touch pad control has additional features that you may choose to use. The following are the features and how you may activate them.

The special feature modes can only be activated while the display is showing the time of day. They remain in the control's memory until the steps are repeated.

When the display shows your choice, touch the **START** pad. The special features will remain in memory after a power failure, except for the Sabbath feature, which will have to be reset.

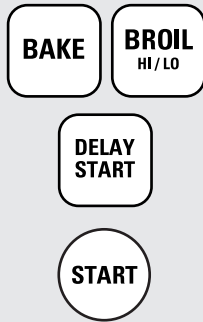

### 12 Hour Shut-Off

With this feature, should you forget and leave the oven on, the control will automatically turn off the oven after 12 hours during baking functions or after 3 hours during a broil function.

If you wish to turn **OFF** this feature, follow the steps below.

- 1 Touch the **BAKE** and **BROIL HI/LO** pads at the same time for 3 seconds until the display shows **SF**.

- 2 Touch the **DELAY START** pad until **no shdn** (no shut-off) appears in the display.

- 3 Touch the **START** pad to lock in the **no shdn** (no shut-off) feature and leave the control set in this special features mode.

**NOTE:** This feature is not available for the lower oven.

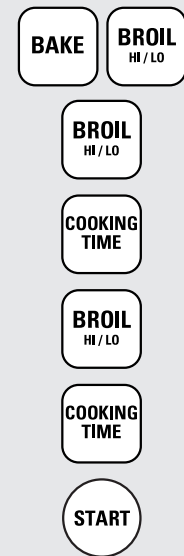

### Fahrenheit or Celsius Temperature Selection

Your oven control is set to use the Fahrenheit temperature selections but you may change this to use the Celsius selections.

- 1 Touch the **BAKE** and **BROIL HI/LO** pads at the same time for 3 seconds until the display shows **SF**.
- 2 Touch the **BROIL HI/LO** and **COOKING TIME** pads at the same time for 2 seconds. The display will show **F** (Fahrenheit).

- 3 Touch the **BROIL HI/LO** and **COOKING TIME** pads again at the same time for 2 seconds. The display will show **C** (Celsius).

- 4 Touch the **START** pad.

**NOTE:** This feature is not available for the lower oven.



### Control Lockout (on some models)

Your control will allow you to lock down the touch pads so they cannot be activated when touched.

- 1 Touch the **BAKE** and **BROIL HI/LO** pads at the same time for 3 seconds until the display shows **SF**.

- 2 Touch the **SELF CLEAN** pad. The display will show **LOC OFF**.

Touch the **SELF CLEAN** pad again. The display will show **LOC ON**.

- 3 Touch the **START** pad to activate the control lockout feature and leave the control set in this special features mode.

When this feature is on and the touch pads are touched, the control will beep and the display will show **LOC**.

To unlock the control, repeat steps 1 and 2. Touch the **START** pad when the display shows **LOC OFF**.

**NOTE:**

■ The control lockout mode will not affect the **TIMER/CLOCK** and **OVEN LIGHT ON/OFF** touch pads.

■ This feature is not available for the lower oven.

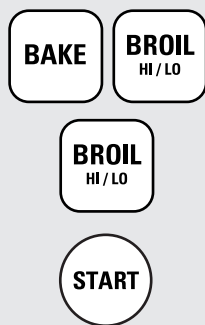

### Tones at the End of a Timed Cycle

At the end of a timed cycle, 3 short beeps will sound followed by one beep every 6 seconds until the **CLEAR/OFF** pad is touched. This continuous 6 second beep may be canceled.

To cancel the 6 second beep:

- 1 Touch the **BAKE** and **BROIL HI/LO** pads at the same time for 3 seconds until the display shows **SF**.

- 2 Touch the **BROIL HI/LO** pad. The display shows **CON BEEP** (continuous beep). Touch the **BROIL HI/LO** pad again. The display shows **BEEP**. (This cancels the one beep every 6 seconds.)
- 3 Touch the **START** pad.

**NOTE:** This feature is not available for the lower oven.

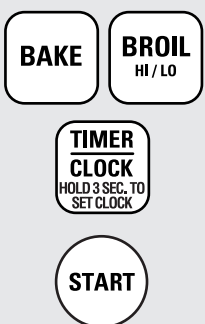

### 12 Hour, 24 Hour or Clock Black-Out

Your control is set to use a 12 hour clock.

If you would prefer to have a 24 hour military time clock or black-out the clock display, follow the steps below.

- 1 Touch the **BAKE** and **BROIL HI/LO** pads at the same time for 3 seconds until the display shows **SF**.
- 2 Touch the **TIMER/CLOCK** pad once. The display will show **12 hr**. If this is the choice you want touch the **START** pad.

Touch the **TIMER/CLOCK** pad again to change to the 24 hour military time clock. The display will show **24 hr**. If this is the choice you want touch the **START** pad.

Touch the **TIMER/CLOCK** pad again to black-out the clock display. The display will show **OFF**. If this is the choice you want touch the **START** pad.

**NOTE:** If the clock is in the black-out mode you will not be able to use the Delay Start function.

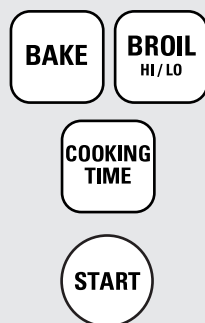

### Cook and Hold

Your new control has a cook and hold feature that keeps cooked foods warm for up to 3 hours after Timed Baking or Roasting is finished.

**NOTE:** This feature can only be programmed to work with Timed Baking or Roasting. (See the Using the timed baking and roasting features section.) After Timed Baking or Roasting has automatically stopped, the programmed Cook and Hold will automatically start.

To activate this feature for use after Timed Baking or Roasting, follow the steps below.

- 1 Touch the **BAKE** and **BROIL HI/LO** pads at the same time for 3 seconds until the display shows **SF**.

- 2 Touch the **COOKING TIME** pad. The display will show **Hid OFF**. Touch the **COOKING TIME** pad again to activate the feature. The display will show **Hid ON**.
- 3 Touch the **START** pad to activate the cook and hold feature and leave the control set in this special features mode.

**NOTE:** This feature is not available for the lower oven.

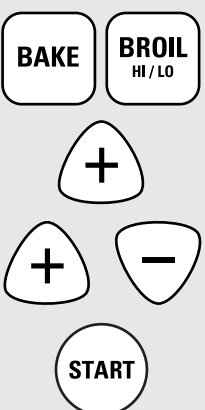

### Changing the Speed of the + or - Pads

As you use the + or - pad when setting a time or temperature, you may notice the display changes slowly. This special feature allows you to change the speed. To set the speed you prefer, follow the steps below.

- 1 Touch the **BAKE** and **BROIL HI/LO** pads at the same time for 3 seconds until the display shows **SF**.
- 2 Touch the **+** pad. The display will show you a set speed between 1 and 5.

- 3 Touch the **+** pad to increase the speed up to the number 5. Touch the **-** pad to decrease the speed down to the number 1.
- 4 Touch **START** to activate the setting and leave the control set in this special features mode.

## Using the Sabbath Feature. (This feature is not available for the lower oven.) (Designed for use on the Jewish Sabbath and Holidays.) (on some models)

The Sabbath feature can be used for baking/roasting only. It cannot be used for broiling, self-cleaning, or Delay Start cooking.

**NOTE:** The oven light comes on automatically (on some models) when the door is opened and goes off when the door is closed. The bulb may be removed. See the Oven Light Replacement section. On models with a light switch on the control panel, the oven light may be turned on and left on.

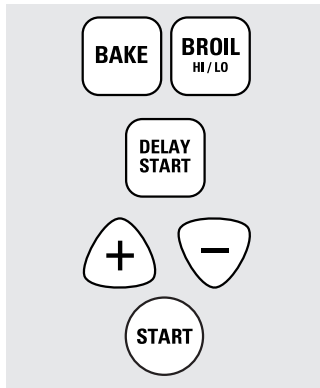

When the display shows  $\supset$  the oven is set in Sabbath. When the display shows  $\supset \subset$  the oven is baking/roasting.

### How to Set Sabbath Feature for Regular Baking/Roasting

**NOTE:** To understand how the oven control works, practice using regular baking (non-Sabbath) before entering Sabbath mode.

Make sure the clock shows the correct time of day.

- 1 Touch and hold **both** the **BAKE** and **BROIL HI/LO** pads, **at the same time**, until the display shows **SF**.
- 2 Tap the **DELAY START** pad until **SAb bAtH** appears in the display.
- 3 Touch the **START** pad and  $\supset$  will appear in the display.
- 4 Touch the **BAKE** pad. No signal will be given.
- 5 The preset starting temperature will automatically be set to 350°. Tap the **+** or **-** pad to increase or decrease the temperature in 5° increments. The temperature can be set between 170° and 550°. No signal or temperature will be given.

- 6 Touch the **START** pad.
- 7 After a random delay period of approximately 30 seconds to 1 minute,  $\supset \subset$  will appear in the display indicating that the oven is baking/roasting. If  $\supset \subset$  does not appear in the display, start again at step 4.

To adjust the oven temperature, touch the **BAKE** pad and tap the **+** or **-** pad to increase or decrease the temperature in 5° increments. Touch the **START** pad.

**NOTE:** The **CLEAR/OFF** and **COOKING TIME** pads are active during the Sabbath feature.

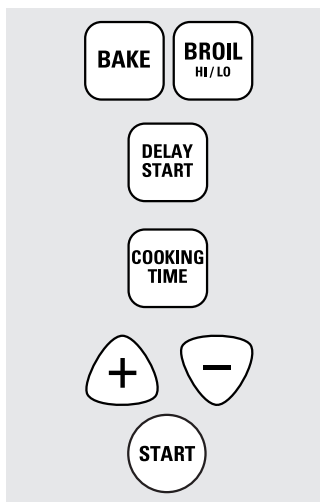

When the display shows  $\supset$  the oven is set in Sabbath. When the display shows  $\supset \subset$  the oven is baking/roasting.

### How to Set Sabbath Feature for Timed Baking/Roasting— Immediate Start and Automatic Stop

**NOTE:** To understand how the oven control works, practice using regular (non-Sabbath) Immediate Start and Automatic Stop before entering the Sabbath mode.

Make sure the clock shows the correct time of day.

- 1 Touch and hold **both** the **BAKE** and **BROIL HI/LO** pads, **at the same time**, until the display shows **SF**.
- 2 Tap the **DELAY START** pad until **SAb bAtH** appears in the display.
- 3 Touch the **START** pad and  $\supset$  will appear in the display.
- 4 Touch the **COOKING TIME** pad.
- 5 Touch the **+** or **-** pad to set the desired length of cooking time between 1 minute and 9 hours and 59 minutes. The cooking time that you entered will be displayed.
- 6 Touch the **START** pad.
- 7 Touch the **BAKE** pad. No signal will be given.

- 8 The preset starting temperature will automatically be set to 350°. Tap the **+** or **-** pad to increase or decrease the temperature in 5° increments. The temperature can be set between 170° and 550°. No signal or temperature will be given.

- 9 Touch the **START** pad.
- 10 After a random delay period of approximately 30 seconds to 1 minute,  $\supset \subset$  will appear in the display indicating that the oven is baking/roasting. If  $\supset \subset$  does not appear in the display, start again at step 7.

To adjust the oven temperature, touch the **BAKE** pad and tap the **+** or **-** pad to increase or decrease the temperature in 5° increments. Touch the **START** pad.

When cooking is finished, the display will change from  $\supset \subset$  to  $\supset$  and **0:00** will appear, indicating that the oven has turned **OFF** but is still set in Sabbath. Remove the cooked food.

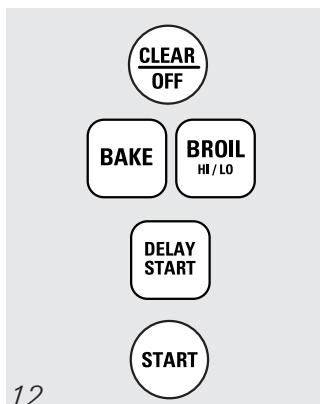

### How to Exit the Sabbath Feature

- 1 Touch the **CLEAR/OFF** pad.
- 2 If the oven is cooking, wait for a random delay period of approximately 30 seconds to 1 minute, until only  $\supset$  is in the display.
- 3 Touch and hold **both** the **BAKE** and **BROIL HI/LO** pads, **at the same time**, until the display shows **SF**.
- 4 Tap the **DELAY START** pad until **12 shdn** or **no shdn** appears in the display. **12 shdn** indicates that the oven will automatically turn off after 12 hours. **no shdn** indicates that the oven will not automatically turn off.

- 5 Touch the **START** pad.

**NOTE:** If a power outage occurred while the oven was in Sabbath mode, the oven will automatically turn off and the oven control must be reset.



# Adjust the oven thermostat—Do it yourself!

GEAppliances.com

You may find that your new oven cooks differently than the one it replaced. Use your new oven for a few weeks to become more familiar with it. If you still think your new oven is too hot or too cold, you can adjust the thermostat yourself.

Do not use thermometers, such as those found in grocery stores, to check the temperature setting of your oven. These thermometers may vary 20–40 degrees.

**NOTE:** This adjustment will not affect the broiling or the self-cleaning temperatures. The adjustment will be retained in memory after a power failure.

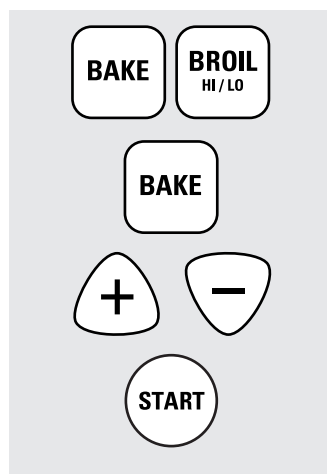

## To Adjust the Oven Thermostat (on the upper oven)

- 1 Touch the **BAKE** and **BROIL HI/LO** pads at the same time for 3 seconds until the display shows **SF**.
- 2 Touch the **BAKE** pad. A two digit number shows in the display.
- 3 The oven temperature can be adjusted up to (+) 35°F hotter or (-) 35°F cooler. Touch the **+** pad to increase the temperature in 1 degree increments. Touch the **-** pad to decrease the temperature in 1 degree increments.
- 4 When you have made the adjustment, touch the **START** pad to go back to the time of day display. Use your oven as you would normally.

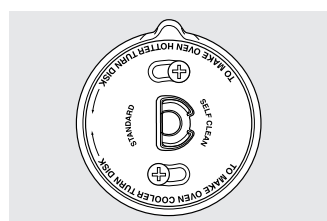

Turn the disk counterclockwise to increase the oven temperature.

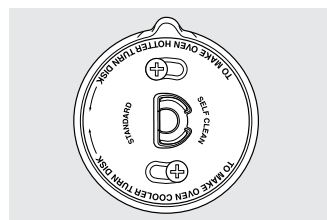

Turn the disk clockwise to decrease the oven temperature.

## To Adjust the Oven Thermostat (on the lower oven) – on some models

Pull the **OVEN** knob off the shaft, look at the back of the knob and note the current setting before making any adjustment. The knob is factory set with the top screw directly under the pointer.

- 1 Pull off the **OVEN** knob.
- 2 Loosen both screws on back of the knob.
- 3 Hold both parts of the knob as shown in the illustration of the back of the **OVEN** knob and turn so the lower screw moves in the desired direction.

You will hear and feel the notches as you turn the knob. Each notch changes temperature about 10° Fahrenheit.

- 4 Tighten the screws.
- 5 Return the **OVEN** knob to the oven.

Re-check oven performance before making any additional adjustments.

# The type of margarine will affect baking performance!

Most recipes for baking have been developed using high fat products such as butter or margarine (80% fat). If you decrease the fat, the recipe may not give the same results as with a higher fat product.

Recipe failure can result if cakes, pies, pastries, cookies or candies are made with low fat spreads. The lower the fat content of a spread product, the more noticeable these differences become.

Federal standards require products labeled “margarine” to contain at least 80% fat by weight. Low fat spreads, on the other hand, contain less fat and more water. The high moisture content of these spreads affect the texture and flavor of baked goods. For best results with your old favorite recipes, use margarine, butter or stick spreads containing at least 70% vegetable oil.

## Using the self-cleaning oven. (on some models)

(This feature is not available for the lower oven.)

The oven door must be closed and all controls must be set correctly for the cycle to work properly.

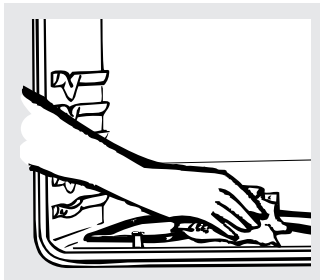

Wipe up heavy soil on the oven bottom. (appearance may vary)

### Before a Clean Cycle

The oven must be cool in order to set the self-clean cycle.

We recommend venting your kitchen with an open window or using a ventilation fan or hood during the first self-clean cycle.

Remove broiler pan, broiler grid, all cookware and any aluminum foil from the oven.

The shiny, silver-colored oven racks (on some models) can be self-cleaned, but they will darken, lose their luster and become hard to slide.

Do not use abrasives or oven cleaners. Clean the top, sides and outside of the oven door with soap and water.

Make sure the oven lightbulb cover (on some models) is in place and the oven light is off.

**IMPORTANT:** The health of some birds is extremely sensitive to the fumes given off during the self-cleaning cycle of any oven. Move birds to another well ventilated room.

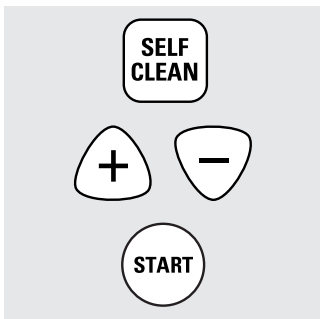

### How to Set the Oven for Cleaning

- 1 Touch the **SELF CLEAN** pad.
- 2 Using the **+** or **-** pad, enter the desired clean time, if a time other than 4 hours is needed.

Clean cycle time is normally 4 hours. You can change the clean time to any time between 3 hours and 5 hours, depending on how dirty your oven is.

- 3 Touch the **START** pad.

The door locks automatically. The display will show the clean time remaining. It will not be possible to open the oven door until the temperature drops below the lock temperature and the **LOCKED** light goes off.

When the **LOCKED** light is off, open the door.

- The word **LOCK** will flash and the oven control will signal if you set the clean cycle and forget to close the oven door.
- To stop a clean cycle, touch the **CLEAR/OFF** pad. When the **LOCKED** light goes off indicating the oven has cooled below the locking temperature, open the door.

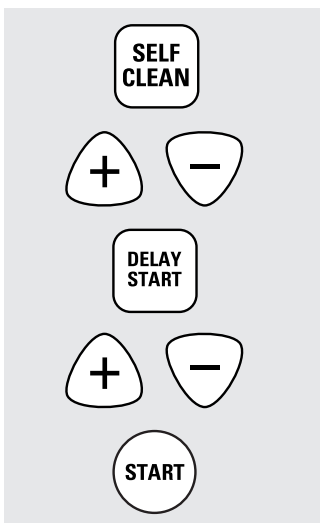

### How to Delay the Start of Cleaning

- 1 Touch the **SELF CLEAN** pad.
- 2 Using the **+** or **-** pad, enter the desired clean time.
- 3 Touch the **DELAY START** pad.
- 4 Using the **+** or **-** pad, enter the time of day you want the clean cycle to start.
- 5 Touch the **START** pad.

The door locks automatically. The display will show the start time. It will not be possible to open the oven door until the temperature drops below the lock temperature and the **LOCKED** light goes off.

When the **LOCKED** light is off, open the door.

### After a Clean Cycle

You may notice some white ash in the oven. Wipe it up with a damp cloth after the oven cools.

*If white spots remain, remove them with a soap-filled scouring pad and rinse thoroughly with a vinegar and water mixture.*

These deposits are usually a salt residue that cannot be removed by the clean cycle.

If the oven is not clean after one clean cycle, repeat the cycle.

- You cannot set the oven for cooking until the oven is cool enough for the door to unlock.
- If the racks become hard to slide, wipe the rack supports with cooking oil.



Be sure electrical power is off and all surfaces are cool before cleaning any part of the oven.

## How to Remove Protective Shipping Film and Packaging Tape

Carefully grasp a corner of the protective shipping film with your fingers and slowly peel it from the appliance surface. Do not use any sharp items to remove the film. Remove all of the film before using the appliance for the first time.

To assure no damage is done to the finish of the product, the safest way to

remove the adhesive from packaging tape on new appliances is an application of a household liquid dishwashing detergent. Apply with a soft cloth and allow to soak.

**NOTE:** The adhesive must be removed from all parts. It cannot be removed if it is baked on.



Lift the door straight up and off the hinges.

## Lift-Off Oven Door

The oven door is removable for easier access to the light bulb.

Do not lift the door by the handle.

**To remove the door,** open it to the broil stop position. Grasp firmly on each side and lift the door straight up and off the hinges.

Do not place hands between the hinge and the oven door frame.

**To replace the door,** make sure the hinges are in the broil stop position. Position the slots in the bottom of the door squarely over the hinges and slowly lower it over both hinges.

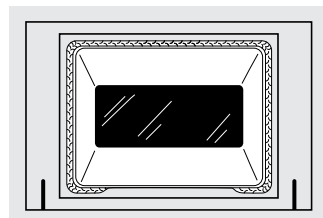

The gasket is designed with a gap at the bottom to allow for proper air circulation.

Do not rub or clean the door gasket—it has an extremely low resistance to abrasion.

If you notice the gasket becoming worn, frayed or damaged in any way or if it has become displaced on the door, you should have it replaced.

## Door (on the upper oven and/or self clean model)

### To clean the inside of the door:

- Because the area inside the gasket is cleaned during the self-clean cycle, you do not need to clean this by hand.
- The area outside the gasket and the door liner can be cleaned with a soap-filled or plastic scouring pad, hot water and detergent. Rinse well with a vinegar and water solution.

### To clean the outside of the door:

- Use soap and water to thoroughly clean the top, sides and front of the oven door. Rinse well. You may also use a glass cleaner to clean the glass

on the outside of the door. Do not let water drip into the vent openings.

- If any stain on the door vent trim is persistent, use a soft abrasive cleaner and a sponge-scrubber for best results.
- Spillage of marinades, fruit juices, tomato sauces and basting materials containing acids may cause discoloration and should be wiped up immediately. When surface is cool, clean and rinse.
- Do not use oven cleaners, cleaning powders or harsh abrasives on the outside of the door.

Do not allow food spills with a high sugar or acid content (such as tomatoes, sauerkraut, fruit juices or pie filling) to remain on the surface. They may cause a dull spot even after cleaning.

## Door (on the lower oven or on standard clean model)

### To clean the inside of the door:

- Soap and water will normally do the job. Heavy spattering or spillovers may require cleaning with a mild abrasive cleaner. Soap-filled scouring pads may also be used.

If necessary, you may use an oven cleaner. Follow the package directions.

- Clean the inside of the oven window with a mild non-scratching cleaner and a damp cloth.

### To clean the outside of the door:

- Use soap and water to thoroughly clean the top, sides and front of the

oven door. Rinse well. You may also use a glass cleaner to clean the glass on the outside of the door. Do not let water drip into the vent openings.

- Spillage of marinades, fruit juices, tomato sauces and basting materials containing acids may cause discoloration and should be wiped up immediately. When surface is cool, clean and rinse.
- Do not use oven cleaners, cleaning powders or harsh abrasives on the outside of the door.

## Care and cleaning of the oven.

Be sure electrical power is off and all surfaces are cool before cleaning any part of the oven.

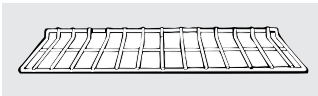

### Oven Racks

Clean the oven racks with an abrasive cleanser or steel wool. After cleaning, rinse the racks with clean water and dry with a clean cloth.

**NOTE:** The shiny, silver-colored oven racks (on some models) may be cleaned in the self-cleaning oven. However, the racks will darken in color, lose their luster and become hard to slide if cleaned during the self-cleaning cycle.

To make the racks slide more easily, apply a small amount of vegetable oil or cooking oil to a paper towel and wipe the edges of the oven racks with the paper towel.

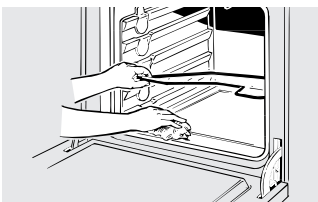

### Oven Heating Elements

Do not clean the bake element or the broil element. Any soil will burn off when the elements are heated.

To clean the oven floor, gently lift the bake element. Clean with warm soapy water.

### Control Panel

It's a good idea to wipe the control panel after each use. Clean with mild soap and water or vinegar and water, rinse with clean water and polish dry with a soft cloth.

Do not use abrasive cleansers, strong liquid cleansers, plastic scouring pads or oven cleansers on the control panel—they will damage the finish. A 50/50 solution of vinegar and hot water works well.

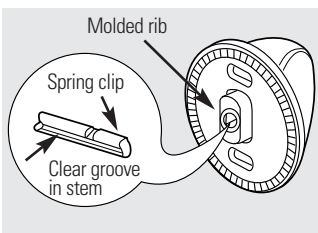

### Control Knob (on some models)

The control knobs may be removed for easier cleaning.

Make sure the knobs are in the **OFF** positions and pull them straight off the stems for cleaning.

The knobs can be cleaned in a dishwasher or they may also be washed with soap and water. Make sure the inside of the knobs are dry before replacing.

Replace the knobs in the **OFF** position to ensure proper placement.

### Painted Surfaces

Clean with soap and water or a vinegar and water solution.

Do not use commercial oven cleaners, cleansing powders, steel wool or harsh abrasives on any painted surface.

### Glass Surfaces

To clean the outside glass finish, use a glass cleaner. Rinse and polish with a dry cloth.

Do not allow the water or cleaner to run down inside the oven door while cleaning.

### Stainless Steel Surfaces (on some models)

**Do not use a steel wool pad; it will scratch the surface.**

To clean the stainless steel surface, use warm sudsy water or a stainless steel cleaner or polish. Always wipe the surface in the direction of the grain. Follow the cleaner instructions for cleaning the stainless steel surface.

To inquire about purchasing stainless steel appliance cleaner or polish, or to find the location of a dealer nearest you, please call our toll-free number:

**National Parts Center**  
**1.800.626.2002**

**GEAppliances.com**

**Non-Self-Clean Oven Interior** (on standard clean models or on lower oven)

With proper care, the porcelain enamel finish on the inside of the oven—top, bottom, sides, back and inside of the door—will stay new-looking for years.

Let the oven cool before cleaning. We recommend that you wear rubber gloves when cleaning the oven.

Soap and water will normally do the job. Heavy spattering or spillovers may require cleaning with a mild abrasive cleaner. Soap-filled scouring pads may also be used.

*Do not allow food spills with a high sugar or acid content (such as tomatoes, sauerkraut, fruit juices or pie filling) to remain on the surface. They may cause a dull spot even after cleaning.*

Household ammonia may make the cleaning job easier. Place 1/2 cup in a shallow glass or pottery container in a cold oven overnight.

The ammonia fumes will help loosen the burned-on grease and food.

If necessary, you may use an oven cleaner. Follow the package directions.

- Do not spray oven cleaner on the electrical controls and switches because it could cause a short circuit and result in sparking or fire.
- Do not allow a film from the cleaner to build up on the temperature sensor—it could cause the oven to heat improperly. (The sensor is located at the top of the oven.) Carefully wipe the sensor clean after each oven cleaning, being careful not to move the sensor as a change in its position could affect how the oven bakes.
- Do not spray any oven cleaner on the oven door, handles or any exterior surface of the oven, cabinets or painted surfaces. The cleaner can damage these surfaces.

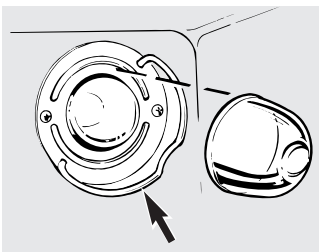

Wire cover holder

**Oven Light Bulb** (on some models)

**⚠ CAUTION:** Before replacing your oven light bulb, disconnect the electrical power to the oven at the main fuse or circuit breaker panel.

Be sure to let the light cover and bulb cool completely.

**To remove the cover:**

- 1 Hold a hand under the cover so it doesn't fall when released. With fingers of the same hand, firmly push back the wire cover holder. Lift off the cover.

Do not remove any screws to remove the cover.

- 2 Replace bulb with a 40-watt appliance bulb.

**To replace the cover:**

- 1 Place it into grooves of the light receptacle. Pull wire forward to the center of the cover until it snaps into place.
- 2 Connect electrical power to the oven.

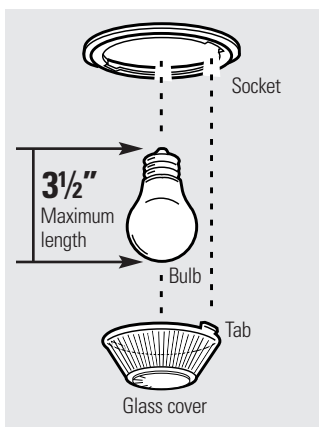

**Oven Light Bulb** (on some models)

**NOTE:** The glass cover (on some models) should be removed only when cold. Wearing latex gloves may offer a better grip.

Before replacing the bulb, disconnect electrical power to the oven at the main fuse or circuit breaker panel. Let the bulb cool completely before removing it. For your safety, do not touch a hot bulb with a damp cloth. If you do, the bulb will break.

**To remove:**

Turn the glass cover counterclockwise 1/4 turn until the tabs of the glass cover clear the grooves of the socket. Remove the bulb.

**To replace:**

Put in a new 40-watt appliance bulb. Place the tabs of the glass cover into the grooves of the socket. Turn the glass cover clockwise 1/4 turn.

**NOTE:**

- A 40-watt appliance bulb is smaller than a standard 40-watt household bulb.
- Install and tighten the cover clockwise.
- Reconnect electrical power to the oven.
- For improved lighting inside the oven, clean the glass cover frequently using a wet cloth. This should be done when the oven is completely cool.

## Before you call for service...



### Troubleshooting Tips

Save time and money! Review the charts on the following pages first and you may not need to call for service.

Problem	Possible Causes	What To Do
<b>Control signals after entering cooking time or delay start</b>	You forgot to enter a bake temperature or cleaning time.	<ul style="list-style-type: none"> <li>• Touch the <b>BAKE</b> pad and desired temperature or the <b>SELF CLEAN</b> pad and desired clean time.</li> </ul>
<b>Food does not bake or roast properly</b>	Oven controls improperly set.	<ul style="list-style-type: none"> <li>• See the <i>Using the oven</i> section.</li> </ul>
	Rack position is incorrect or the rack is not level.	<ul style="list-style-type: none"> <li>• See the <i>Using the oven</i> section.</li> </ul>
	Incorrect cookware or cookware of improper size being used.	<ul style="list-style-type: none"> <li>• See the <i>Using the oven</i> section.</li> </ul>
	Oven thermostat needs adjustment.	<ul style="list-style-type: none"> <li>• See the <i>Adjust the oven thermostat—Do it yourself!</i> section.</li> </ul>
<b>Food does not broil properly</b>	Door not open to the broil stop position as recommended.	<ul style="list-style-type: none"> <li>• See the <i>Using the oven</i> section.</li> </ul>
	Oven controls improperly set.	<ul style="list-style-type: none"> <li>• Make sure you touch the <b>BROIL HI/LO</b> pad.</li> </ul>
	Improper rack position being used.	<ul style="list-style-type: none"> <li>• See the <i>Broiling Guide</i>.</li> </ul>
	Food being cooked in a hot pan.	<ul style="list-style-type: none"> <li>• For best results, use a pan designed for broiling. Make sure it is cool.</li> </ul>
	Cookware not suited for broiling.	<ul style="list-style-type: none"> <li>• For best results, use a pan designed for broiling.</li> </ul>
	In some areas the power (voltage) may be low.	<ul style="list-style-type: none"> <li>• Preheat the broil element for 10 minutes.</li> <li>• Broil for the longest period of time recommended in the <i>Broiling Guide</i>.</li> </ul>
<b>Clock and timer do not work</b>	A fuse in your home may be blown or the circuit breaker tripped.	<ul style="list-style-type: none"> <li>• Replace the fuse or reset the circuit breaker.</li> </ul>
	Oven controls improperly set.	<ul style="list-style-type: none"> <li>• See the <i>Using the clock and timer</i> section.</li> </ul>
<b>Oven light does not work</b>	Lightbulb is loose or defective.	<ul style="list-style-type: none"> <li>• Tighten or replace the bulb.</li> </ul>
	Pad operating light is broken.	<ul style="list-style-type: none"> <li>• Call for service.</li> </ul>

<b>Problem</b>	<b>Possible Causes</b>	<b>What To Do</b>
<b>Oven temperature too hot or too cold</b>	Oven thermostat needs adjustment.	<ul style="list-style-type: none"> <li>• See the <i>Adjust the oven thermostat—Do it yourself!</i> section.</li> </ul>
<b>Oven will not work</b>	A fuse in your home may be blown or the circuit breaker tripped.	<ul style="list-style-type: none"> <li>• Replace the fuse or reset the circuit breaker.</li> </ul>
	Oven controls improperly set.	<ul style="list-style-type: none"> <li>• See the <i>Using the oven</i> section.</li> </ul>
<b>Oven will not self-clean</b>	The oven temperature is too high to set a self-clean operation.	<ul style="list-style-type: none"> <li>• Allow the oven to cool to room temperature and reset the controls.</li> </ul>
	Oven controls improperly set.	<ul style="list-style-type: none"> <li>• See the <i>Using the self-cleaning oven</i> section.</li> </ul>
<b>“Crackling” or “popping” sound</b>	This is the sound of the metal heating and cooling during both the cooking and cleaning functions.	<ul style="list-style-type: none"> <li>• This is normal.</li> </ul>
<b>Excessive smoking during clean cycle</b>	Excessive soil.	<ul style="list-style-type: none"> <li>• Touch the <b>CLEAR/OFF</b> pad. Open the windows to rid the room of smoke. Wait until the <b>LOCKED</b> light goes off. Wipe up the excess soil and reset the clean cycle.</li> </ul>
<b>Oven door will not open after a clean cycle</b>	Oven too hot.	<ul style="list-style-type: none"> <li>• Allow the oven to cool below locking temperature.</li> </ul>
<b>Oven not clean after a clean cycle</b>	Oven controls improperly set.	<ul style="list-style-type: none"> <li>• See the <i>Using the self-cleaning oven</i> section.</li> </ul>
	Oven was heavily soiled.	<ul style="list-style-type: none"> <li>• Clean up heavy spillovers before starting the clean cycle. Heavily soiled ovens may need to self-clean again or for a longer period of time.</li> </ul>
<b>“LOCK DOOR” flashes in the display</b>	The self-clean cycle has been selected but the door is not closed.	<ul style="list-style-type: none"> <li>• Close the oven door.</li> </ul>
<b>LOCKED light is on when you want to cook</b>	The oven door is locked because the temperature inside the oven has not dropped below the locking temperature.	<ul style="list-style-type: none"> <li>• Touch the <b>CLEAR/OFF</b> pad. Allow the oven to cool.</li> </ul>

## Before you call for service...



### Troubleshooting Tips

Problem	Possible Causes	What To Do
"F— and a number or letter" flash in the display	You have a function error code.	<ul style="list-style-type: none"> <li>• Touch the <b>CLEAR/OFF</b> pad. Allow the oven to cool for one hour. Put the oven back into operation.</li> </ul>
	If the function code repeats.	<ul style="list-style-type: none"> <li>• Disconnect all power to the oven for at least 30 seconds and then reconnect power. If the function error code repeats, call for service.</li> </ul>
Display goes blank	A fuse in your home may be blown or the circuit breaker tripped.	<ul style="list-style-type: none"> <li>• Replace the fuse or reset the circuit breaker.</li> </ul>
	The clock is in the black-out mode.	<ul style="list-style-type: none"> <li>• See the <i>Special features of your oven control</i> section.</li> </ul>
Display flashes	Power failure.	<ul style="list-style-type: none"> <li>• Reset the clock.</li> </ul>
Unable to get the display to show "SF"	Oven control pads were not pressed properly.	<ul style="list-style-type: none"> <li>• The <b>BAKE</b> and <b>BROIL HI/LO</b> pads must be touched at the same time and held for 3 seconds.</li> </ul>
Power outage, clock flashes	Power outage or surge.	<ul style="list-style-type: none"> <li>• Reset the clock. If the oven was in use, you must reset it by touching the <b>CLEAR/OFF</b> pad, setting the clock and resetting any cooking function.</li> </ul>
"Burning" or "oily" odor emitting from the vent	This is normal in a new oven and will disappear in time.	<ul style="list-style-type: none"> <li>• To speed the process, set a self-clean cycle for a minimum of 3 hours. See the <i>Using the self-cleaning oven</i> section.</li> </ul>
Strong odor	An odor from the insulation around the inside of the oven is normal for the first few times the oven is used.	<ul style="list-style-type: none"> <li>• This is temporary.</li> </ul>
Fan noise	A cooling fan may automatically turn on.	<ul style="list-style-type: none"> <li>• This is normal. The cooling fan will turn on to cool internal parts. It may run for up to 2 hours after the oven is turned off.</li> </ul>





## Looking For Something More?

You can find these accessories and many more at [GEAppliances.com](http://GEAppliances.com) (U.S.) or [www.GEAppliances.ca](http://www.GEAppliances.ca) (Canada), or call **800.626.2002** (U.S.) or **800.661.1616** (Canada) (during normal business hours). Have your model number ready.

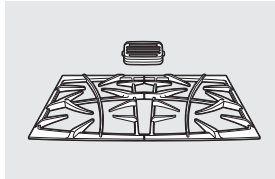

Grates

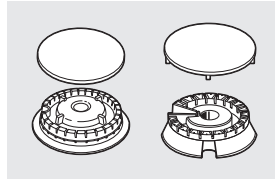

Surface Burner Heads and Caps

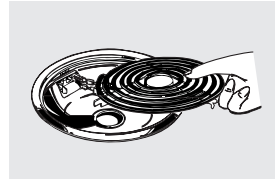

Surface Elements and Drip Pans

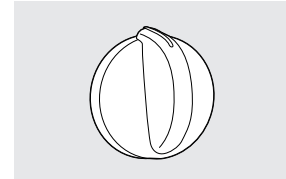

Knobs

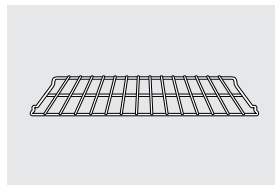

Oven Racks

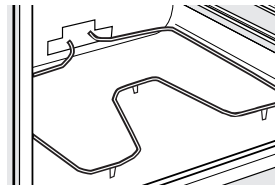

Oven Elements

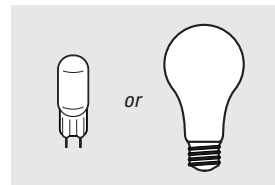

Light Bulbs

## Experience these other great products to keep your kitchen looking great!



**Ceramic Cooktop Cleaning Kit:**  
Includes cleaner, scraper and pad

WX10X117GCS



**Ceramic Cooktop Cleaning Wipes**

WX10X305



**Stainless Steel Appliance Polish Wipes**

WX10X10001



**Stainless Steel Appliance Cleaner**

PM10X311

## Get the most out of your Broiler Pan! (Not for use with Broiler Drawer models.)

Use your pan and grid cover to broil hamburgers, seafood, steaks, vegetables, bacon, chops and so much more! The pan below catches the excess fats and oils.

- Genuine GE Part
- Easy To Clean
- One-Year Warranty

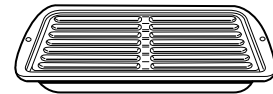

## Limited Time Offer! Free Shipping!

When you order your broiler pan **within 30 days** of purchasing your GE cooking product.

	Small	Large*	XL**
<b>U.S. Part #</b>	WB48X10055	WB48X10056	WB48X10057
<b>Canada Part #</b>	222D2097G001	222D2097G002	N/A
<b>Dimensions</b>	8-3/4" W x 1-1/4" H x 13-1/2" D	12-3/4" W x 1-1/4" H x 16-1/2" D	17" W x 1-1/4" H x 19-1/4" D
<b>Price</b>	<b>US\$10.50†</b>	<b>US\$14.50†</b>	<b>US\$16.75†</b>

† Plus applicable state sales tax (PST/HST and GST)

\* The large (standard) broil pan does not fit in 20"/24" ranges.

\*\* The XL pan does not fit in 24" wall ovens, 27" drop-ins or 20"/24" ranges.

To place your order, call **800.626.2002** (U.S.), **800.661.1616** (Canada) or mail this form to:

**In the U.S.:** GE Parts, P.O. Box 221027, Memphis, TN 38122-1027. **In Canada:** GE Parts, 1 Factory Lane, Moncton, N.B. E1C 9M3

## Broiler Pan Order Form

Quantity \_\_\_\_\_ Part Number \_\_\_\_\_

Model Number \_\_\_\_\_ Serial Number \_\_\_\_\_ Brand \_\_\_\_\_ Date of Purchase \_\_\_\_\_

First Name \_\_\_\_\_ Last Name \_\_\_\_\_

Address \_\_\_\_\_

City \_\_\_\_\_ State \_\_\_\_\_ Zip Code \_\_\_\_\_

Phone \_\_\_\_\_ E-Mail \_\_\_\_\_

Credit Card \_\_\_\_\_ Check \_\_\_\_\_ Money Order \_\_\_\_\_

Visa \_\_\_\_\_ MasterCard \_\_\_\_\_ Discover \_\_\_\_\_ AmEx \_\_\_\_\_ Credit Card # \_\_\_\_\_

Exp. Date: Month \_\_\_\_\_ Year \_\_\_\_\_ Signature: \_\_\_\_\_

<b><i>Consumer Support</i></b>	<b><i>Troubleshooting Tips</i></b>	<b><i>Care and Cleaning</i></b>	<b><i>Operating Instructions</i></b>	<b><i>Safety Instructions</i></b>
--------------------------------	------------------------------------	---------------------------------	--------------------------------------	-----------------------------------

***Notes.***

---

# GE Built-In Electric Oven Warranty.



All warranty service provided by our Factory Service Centers, or an authorized Customer Care® technician. To schedule service on-line, visit us at [GEAppliances.com](http://GEAppliances.com), or call 800.GE.CARES (800.432.2737). Please have serial number and model number available when calling for service.

Staple your receipt here.  
Proof of the original purchase date is needed to obtain service under the warranty.

For The Period Of:	GE Will Replace:
<b>One Year</b> From the date of the original purchase	<b>Any part</b> of the oven which fails due to a defect in materials or workmanship. During this <b>limited one-year warranty</b> , GE will also provide, <b>free of charge</b> , all labor and in-home service to replace the defective part.

## What GE Will Not Cover:

- Service trips to your home to teach you how to use the product.
- Improper installation, delivery or maintenance.
- Failure of the product if it is abused, misused, or used for other than the intended purpose or used commercially.
- Replacement of house fuses or resetting of circuit breakers.
- Damage to the product caused by accident, fire, floods or acts of God.
- Incidental or consequential damage caused by possible defects with this appliance.
- Damage caused after delivery.
- Product not accessible to provide required service.

**EXCLUSION OF IMPLIED WARRANTIES**—Your sole and exclusive remedy is product repair as provided in this Limited Warranty. Any implied warranties, including the implied warranties of merchantability or fitness for a particular purpose, are limited to one year or the shortest period allowed by law.

This warranty is extended to the original purchaser and any succeeding owner for products purchased for home use within the USA. If the product is located in an area where service by a GE Authorized Servicer is not available, you may be responsible for a trip charge or you may be required to bring the product to an Authorized GE Service location for service. In Alaska, the warranty excludes the cost of shipping or service calls to your home.

Some states do not allow the exclusion or limitation of incidental or consequential damages. This warranty gives you specific legal rights, and you may also have other rights which vary from state to state. To know what your legal rights are, consult your local or state consumer affairs office or your state's Attorney General.

**Warrantor: General Electric Company, Louisville, KY 40225**

## Consumer Support.

---



### *GE Appliances Website*

**GEAppliances.com**

Have a question or need assistance with your appliance? Try the GE Appliances Website 24 hours a day, any day of the year! For greater convenience and faster service, you can now download Owner's Manuals, order parts or even schedule service on-line.



### *Schedule Service*

**GEAppliances.com**

Expert GE repair service is only one step away from your door. Get on-line and schedule your service at your convenience any day of the year! Or call 800.GE.CARES (800.432.2737) during normal business hours.



### *Real Life Design Studio*

**GEAppliances.com**

GE supports the Universal Design concept—products, services and environments that can be used by people of all ages, sizes and capabilities. We recognize the need to design for a wide range of physical and mental abilities and impairments. For details of GE's Universal Design applications, including kitchen design ideas for people with disabilities, check out our Website today. For the hearing impaired, please call 800.TDD.GEAC (800.833.4322).



### *Extended Warranties*

**GEAppliances.com**

Purchase a GE extended warranty and learn about special discounts that are available while your warranty is still in effect. You can purchase it on-line anytime, or call 800.626.2224 during normal business hours. GE Consumer Home Services will still be there after your warranty expires.

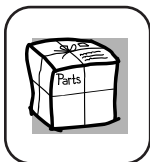

### *Parts and Accessories*

**GEAppliances.com**

Individuals qualified to service their own appliances can have parts or accessories sent directly to their homes (VISA, MasterCard and Discover cards are accepted). Order on-line today, 24 hours every day or by phone at 800.626.2002 during normal business hours.

**Instructions contained in this manual cover procedures to be performed by any user. Other servicing generally should be referred to qualified service personnel. Caution must be exercised, since improper servicing may cause unsafe operation.**



### *Contact Us*

**GEAppliances.com**

If you are not satisfied with the service you receive from GE, contact us on our Website with all the details including your phone number, or write to: General Manager, Customer Relations  
GE Appliances, Appliance Park  
Louisville, KY 40225



### *Register Your Appliance*

**GEAppliances.com**

**Register your new appliance on-line—at your convenience!** Timely product registration will allow for enhanced communication and prompt service under the terms of your warranty, should the need arise. You may also mail in the pre-printed registration card included in the packing material.