

# OVEN 700 SERIES 30"













CODE ID

30" TOUCH CONTROL SINGLE OVEN - STAINLESS STEEL

**F7SP30S1**



-  **CREACTIVE COOKING SYSTEM**
-  **PIZZA COOKING MODE 590 °F**
-  Dual Convection
-  Self Clean Oven
-  Multi-level cooking
-  1 Telescopic Rack
-  Cool Touch Door
-  TFT Display
-  Meat Probe
-  Fast Pre-Heat
-  Interior Lighting

## OVEN

Creative Touch Control System  
Dual True Convection  
Self-cleaning oven with Multifunction baking  
Black Porcelain enamel interior  
Cool to the touch  
Extra-large baking cavity and viewing area  
3 Halogen lights for flawless visibility  
Gross capacity 4.4 cu. ft.  
2 chromed racks  
1 telescopic rack  
Enameled Broiler Pan  
Lock Keys  
Door Lock

## OVEN FUNCTIONS

Bake (cooking group)  
Broil  
Convection (cooking group)  
Keep Warm (cooking group)  
Recipes  
Classic Pizza Function 590°F  
Preset default temperature  
Preheat (display instantaneous temperature)  
Fast Preheat Mode  
Sabbath Mode  
Setting Temperature °C/°F  
Setting Weight Kg/lb  
Event Logs (for Service)  
Meat Probe  
Self-Clean

## OPTIONAL ACCESSORIES

FMTR630 30" Telesc. Rack



This product meets ADA (Americans with Disabilities Act) requirements. Please check with your local municipality's codes and stipulations for additional details to ensure compliance.

# DISTINTO

30" TOUCH CONTROL SINGLE OVEN



**F7SP30S1**  
Stainless Steel



**F7SP30B1**  
Black Glass



**F7SP30W1**  
White Glass

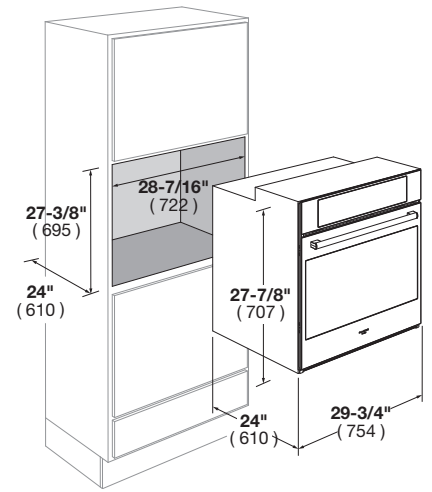

CODE ID	F7SP30S1 30" TOUCH CONTROL OVEN	F7SP30B1 30" TOUCH CONTROL OVEN	F7SP30W1 30" TOUCH CONTROL OVEN
Series and Finish	700 Series - Stainless Steel	700 Series - Black Glass	700 Series - White Glass
<b>CONTROL PANEL</b>	Creative Electronic Touch Control		
Control Type	TFT 3.5"		
Display: Clock - Temperature - Function	English (USA) / English (UK) / French / Spanish / Italian / German		
Language	Control Interface	Chime Volume Setting	
	Full Touch: Functions - Recipes	Date Format	
	Settings Menu - Brightness Setting	Demo Mode	
<b>OVEN</b>	Dual True Convection		
Type	Electronic Control (min/max 170/550°F - 75/290°C)		
Temperature Regulation			
<b>OVEN FUNCTIONS</b>	Pyrolytic Self-Clean	Broil	
	True Convection	Dehydrate	
	Convection Broil	Thaw (Defrost)	
	Convection Roast	Proof (Warm)	
	Pizza (Lower Convection)	Keep warm (Warm Plus)	
	Bake	Oven Lights	
<b>ELECTRIC OVEN FEATURES</b>	Preset default temperature	Display instantaneous temperature	
	Child Door Lock	Control Display Lock	
	Sabbath Mode	12/24 Hour Clock Formats	
	Automatic Fast Preheat	Display	
	Meat Probe (Upper Oven Only)	Event Logs (for Service)	
<b>OVEN DOOR(S)</b>	Large See Through Glass		
Oven Glass Window	4 Heat Resistant Glasses		
Door Cooling System	Heavy Duty Steady Tilt		
Door Hinges			
<b>OVEN CAVITY</b>	4.4		
Gross Capacity (cbft)	4.1		
Usable Capacity (cbft)	Black		
Cavity Enamel Colour	6		
Rack Positions	3x20W Halogen		
Oven Lights			
<b>HEATING ELEMENTS (@240V)</b>	3500 W		
Broil Upper Heating Element	1032 W		
Upper Auxiliary Element	3000 W		
Concealed Bake Lower Heating Element	2 x 1300 W		
Convection Element			
<b>OVEN ACCESSORIES</b>	2		
Chromed Racks	1		
Enameled Broiler Pan (basin + anti splash)	1		
Telescopic Chromed Rack			
<b>DIMENSIONS/WEIGHT</b>	Overall dim - Width	29 - 11/16"	(754 mm)
	Overall dim - Height	27 - 7/8"	(707 mm)
	Overall dim - Depth	24"	(610 mm)
	Cut-out - Width	28 - 7/16"	(722 mm)
	Cut-out - Height (min)	27 - 3/8"	(695 mm)
	Cut-out - Depth (min)	23 - 1/4"	(590 mm)
	Gross Weight	183 lbs	(83 kg)
<b>POWER / RATINGS (208/240 V, 60 HZ)</b>	3.70kW - 15.4A		
kW / Amps rating at 120-240V, 60Hz	3.50kW - 16.8A		
kW / Amps rating at 120-208V, 60Hz	Conduit		
Power Cable			
<b>INSTRUCTIONS FOR USE</b>	English / French / Spanish		
Use & Care Manual / Installation Manual			