

All about the

Use & Care

of your Gas Range



TABLE OF CONTENTS

Product Record and Registration	2	Setting Oven Controls	12
Important Safety Instructions	3	Care and Cleaning	19
Before Setting Surface Controls	8	Warranty	25
Before Setting Oven Controls	10		

PRODUCT RECORD AND REGISTRATION

Need Help?	2
Product Registration	2
Product Record and Registration	2
Important Safety Instructions	3
Before Setting Surface Controls	8
Before Setting Oven Controls	10
Setting Oven Controls	12
Care and Cleaning	19
Warranty	25

Thank you for choosing Frigidaire.

Important: This Use and Care Guide is part of our commitment to customer satisfaction and product quality throughout the service life of your new appliance. We view your purchase as the beginning of a relationship. To ensure our ability to continue serving you, please use this page to record important product information.

Need Help?

Visit the Frigidaire web site at www.frigidaire.com

Before you call for service, there are a few things you can do to help us serve you better.

Read this Use & Care Manual

This manual contains instructions to help you use and maintain your range properly.

If You Received a Damaged Range...

Immediately contact the dealer (or builder) that sold you the range.

Save Time and Money

Check the section title "Before You Call". This section helps step you through some common problems that might occur.

If you do need service, help is only a phone call away. Call Frigidaire Customer Services at **1-800-944-9044**.

Product Registration

Registering your product with Frigidaire enhances our ability to serve you. Register online at www.frigidaire.com or by dropping your Product Registration Card in the mail.

Record model & serial numbers here

Purchase Date

Frigidaire model number

Frigidaire serial number

Serial Plate Location



Questions?

For toll-free telephone support in the U.S. or Canada call **1-800-944-9044**

For online support and production information visit <http://www.frigidaire.com>.

IMPORTANT SAFETY INSTRUCTIONS

CAUTIONS & WARNINGS

This manual contains important safety symbols and instructions. Please pay attention to these symbols and follow all instructions given. Do not attempt to install or operate your appliance until you have read the safety precautions in this manual. Safety items throughout this manual are labeled with a WARNING or CAUTION statement based on the risk type.

DEFINITIONS

 This is the safety alert symbol. It is used to alert you to potential personal injury hazards. Obey all safety messages that follow this symbol to avoid possible injury or death.

WARNING

Indicates a potentially hazardous situation which, if not avoided, may result in death or serious injury.

CAUTION

Indicates a potentially hazardous situation which, if not avoided, may result in minor or moderate injury.

IMPORTANT

Indicates installation, operation, maintenance, or valuable information that is not hazard related.

WARNING

- Do not leave children alone - children should not be left alone or unattended in the area where appliance is in use. They should never be allowed to sit or stand on any part of the appliance, including the storage drawer, lower broiler drawer, warmer drawer, or lower double oven.
- Stepping, leaning or sitting on the door or drawers of a range can result in serious injuries and also cause damage to the appliance. Do not allow children to climb or play around the range. The weight of a child on an open oven door, may cause the range to tip, resulting in serious burns or other injury.

WARNING! If the information in this manual is not followed exactly, a fire or explosion may result causing property damage, personal injury or death.

FOR YOUR SAFETY:

Do not store or use gasoline or other flammable vapors and liquids in the vicinity of this or any other appliance.

WHAT TO DO IF YOU SMELL GAS:

- Do not try to light any appliance.
- Do not touch any electrical switch; do not use any phone in your building.
- Immediately call your gas supplier from a neighbor's phone. Follow the gas supplier's instructions.
- If you cannot reach your gas supplier, call the fire department.
- Installation and service must be performed by a qualified installer, service technician or the gas supplier.

IMPORTANT

Important Safety Notice - The California Safe Drinking Water and Toxic Enforcement Act requires the Governor of California to publish a list of substances known to cause cancer, birth defects or other reproductive harms, and requires businesses to warn customers of potential exposures to such substances.

WARNING

Do not store or use gasoline or other flammable vapors and liquids in the vicinity of this or any other appliance.

IMPORTANT SAFETY INSTRUCTIONS

WARNING

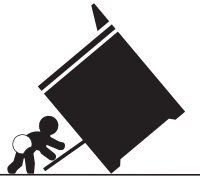

Tip Over Hazard

- **A child or adult can tip the range and be killed.**
- **Verify the anti-tip device has been installed to floor or wall.**

- **Ensure the anti-tip device is re-engaged to floor or wall when the range is moved.**
- **Do not operate the range without the anti-tip device in place and engaged.**
- **Failure to follow these instructions can result in death or serious burns to children and adults.**

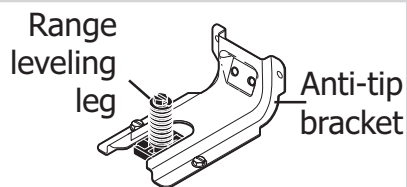

To check if the anti-tip bracket is installed properly, use both arms to grasp the rear edge of the range back. Carefully attempt to tilt range forward. When properly installed, the range should not tilt forward.

Refer to the anti-tip bracket installation instructions supplied with your range for proper installation.

WARNING

Personal injury or death from electrical shock may occur if the conversion to L.P. gas is not made by a qualified installer or electrician. Any additions, changes or conversions required in order for this appliance to satisfactorily meet the application needs must be made by a qualified technician.

WARNING

- Storage in or on appliance—flammable materials should not be stored in an oven, near surface units, or in the storage drawer, warmer drawer, or lower oven. This includes paper, plastic and cloth items such as cookbooks, plastic ware and towels, as well as flammable liquids. Do not store explosives, such as aerosol cans, on or near the range.
- Never cover any slots, holes, or passages in the oven bottom or cover an entire oven rack with materials such as aluminum foil. Aluminum foil linings may trap heat, causing a fire hazard.

IMPORTANT

- Do not operate range during a power failure. If power fails, turn off range. If range is not turned off and power resumes, the range may begin to operate again. Once the power resumes, reset the clock and oven function.
- Cold temperatures can damage the electronic control. When using this appliance for the first time, or when the appliance has not been used for an extended period of time, be sure the appliance has been in temperatures above 32°F (0°C) for at least 3 hours before turning on the power to the appliance.
- Remove the oven door from any unused range if it is to be stored or discarded.
- Be sure to have an appropriate foam-type fire extinguisher available, visible, and easily accessible located near the appliance.

IMPORTANT SAFETY INSTRUCTIONS

IMPORTANT

Read and follow these instructions and precautions for unpacking, installing, and servicing your appliance:

- Remove all tape and packaging before using the range. Destroy the carton and plastic bags after unpacking the range. Never allow children to play with packaging material.
- Proper Installation—Be sure your appliance is properly installed and grounded by a qualified technician in accordance with the National Fuel Gas Code ANSI Z223.- latest edition, or in Canada CAN/CGA B149.1, and CAN/CGA B149.2, and the National Electrical Code ANSI/NFPA No.70-latest edition, or in Canada CSA Standard C22.1, Canadian Electrical Code, Part 1, and local code requirements. Install only per installation instructions provided in the literature package for this range. Ask your dealer to recommend a qualified technician and an authorized repair service. Know how to disconnect the power to the range at the circuit breaker or fuse box in case of an emergency.
- User servicing—Do not repair or replace any part of the appliance unless specifically recommended in the manuals. All other servicing should be done only by a qualified technician. This reduces the risk of personal injury and damage to the range. Ask your dealer to recommend a qualified technician and an authorized repair service. Know how to disconnect the power to the range at the circuit breaker or fuse box in case of an emergency.
- Remove the oven door from any unused range if it is to be stored or discarded.
- Never modify or alter the construction of a range by removing the leveling legs, panels, wire covers, anti-tip brackets/screws, or any other part of the range.

CAUTION

- Do not store items of interest to children in the cabinets above a range on the backguard of the ranges. Children climbing on the range to reach items could be seriously injured.
- Do not touch surface heating units or surface cooking elements, areas near these units or elements, or interior surface of the oven. Surface heating areas and oven heating elements may be hot even though they appear cool. Areas near surface cooking units may become hot enough to cause burns. During and after use, do not touch, or let clothing or other flammable materials touch these areas until they are cool. These areas may include the cook top, surfaces facing the cook top, oven vent areas, oven door, and oven window.
- Wear proper apparel. Loose-fitting or hanging garments should never be worn while using this appliance. Do not let clothing or other flammable materials come into contact with hot surfaces.
- Do not heat unopened food containers. Build-up of pressure may cause container to burst and result in injury.
- When heating fat or grease, watch it closely. Fat or grease may catch fire if it becomes too hot.
- Do not use water or flour on grease fires. Cover the fire with a pan lid, use baking soda, or use a dry chemical or foam type extinguisher.
- Use dry potholders. Moist or damp potholders on hot surfaces may result in burns from steam. Do not let potholders touch hot cooking areas. Do not use towels or other bulky cloths.

IMPORTANT SAFETY INSTRUCTIONS

CONVERSION TO L.P. GAS

This appliance allows for conversion to Liquefied Petroleum (L.P.) Gas.

If L.P. conversion is needed, contact your local L.P. Gas provider for assistance. The L.P. conversion kit is provided with this appliance and is located on the lower REAR (back side) panel of the range. Before installing the kit be sure to read the L.P. Installation Instructions and follow them carefully when making the installation.

IMPORTANT INSTRUCTIONS FOR USING YOUR OVEN

- Never use the appliance for warming or heating the room. Doing so may result in carbon monoxide poisoning.
- Use care when opening oven door, lower oven door, or warmer drawer (some models). Stand to the side of the range when opening the door of a hot oven. Let hot air or steam escape before you remove or replace food in the oven.
- Keep oven vent ducts clear. Touching surfaces in this area when the oven is on may cause severe burns. Do not place plastic or heat-sensitive items on or near the oven vent. These items can melt or ignite.
- Always handle oven racks when the oven is cool. Place oven racks in desired positions while the oven is cool. If a rack must be moved while the oven is hot, use extreme caution. Use potholders and grasp the rack with both hands to reposition. Do not let potholders contact the hot heating elements in the oven. Remove all cookware and utensils before moving the rack.
- Do not use a broiler pan without its insert. Do not cover the broiler insert with aluminum foil; exposed fat and grease could ignite.
- Do not use aluminum foil or other protective liners to line the oven bottom. Only use aluminum foil as recommended in this manual. Improper installation of these liners may result in risk of electric shock or fire.

- Do not cook food on the oven bottom. Always cook in proper cookware and always use the oven racks.

IMPORTANT INSTRUCTIONS FOR USING YOUR COOK TOP

WARNING

Use Proper Flame Size — Adjust flame size so it does not extend beyond the edge of the utensil. The use of undersized utensils will expose a portion of the burner flame to direct contact and may result in ignition of clothing.

- Know which knob controls each surface burner. Place a pan of food on the burner before turning it on, and turn the burner off before removing the pan.
- Always turn knob to the full LITE position when igniting top burners and check that burner has lit. Adjust flame so it does not extend beyond the edge of cookware.
- Utensil handles should be turned inward and not extend over adjacent surface burners.
- Never leave surface burners unattended at high heat settings — spill overs cause smoking and greasy spills that may ignite, or a pan that has boiled dry may melt.
- Glazed cooking utensils — Only certain types of cookware are suitable for cook top service without breaking due to the sudden change in temperature. Check the manufacturer's recommendations for cook top use.
- When you are flaming foods under a ventilating hood, turn the fan on.

IMPORTANT SAFETY INSTRUCTIONS

IMPORTANT INSTRUCTIONS FOR CLEANING YOUR RANGE

CAUTION

Before manually cleaning any part of the range, be sure all controls are turned off and the range is cool. Cleaning a hot range can cause burns.

- Clean the range regularly to keep all parts free of grease that could catch fire. Pay particular attention to the area around each burner element. Do not allow grease to accumulate.
- Always follow the manufacturer's recommended directions for use of kitchen cleaners and aerosols. Be aware that excess residue from cleaners and aerosols may ignite causing damage and injury.
- Clean ventilating hoods frequently. Grease should not be allowed to accumulate on the hood or filter. Follow the manufacturer's instructions for cleaning hoods.

SELF-CLEANING OVENS

- Use the self-clean cycle to clean only the parts listed in this manual. Before using self-clean, remove the broiler pan, any food, utensils, and cookware from the oven. Remove oven racks unless otherwise instructed.
- Do not use oven cleaners. No commercial oven cleaner, oven liner, or protective coating of any kind should be used in or around any part of the oven.
- Do not clean the oven door gasket. The door gasket is essential for a good seal. Do not rub, damage, or move the gasket.
- Some birds are extremely sensitive to the fumes given off during the self-clean cycle of any range. Move birds to another well-ventilated room.

GROUNDING INSTRUCTIONS

For personal safety, the cook top must be properly grounded. For maximum safety, the power cord must be plugged into an electrical outlet that is correctly polarized and properly grounded.

Do not operate the cook top using a 2-prong adapter or an extension cord. If a 2-prong wall receptacle is the only available outlet, it is the personal responsibility of the consumer to have it replaced with a properly grounded 3-prong wall receptacle installed by a qualified electrician.

See the installation instructions packaged with this cook top for complete installation and grounding instructions.

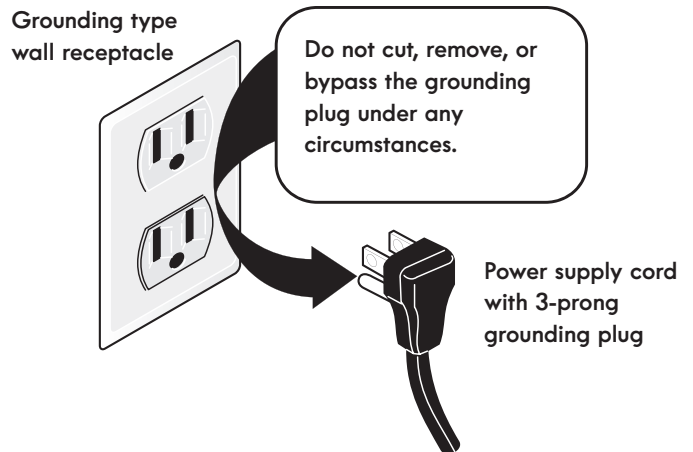

WARNING

Avoid fire hazard or electrical shock. Do not use an adapter plug, and extension cord, or remove grounding prong from the power cord. Failure to follow this warning may cause serious injury, fire, or death.

This appliance is equipped with a 3-prong grounding plug. For your protection it should be plugged directly into a properly grounded receptacle. Do not cut or remove the grounding prong from this plug.

BEFORE SETTING SURFACE CONTROLS

Control locations of the gas surface burners

Your built-in range is equipped with gas surface burners with different BTU ratings. The ability to heat food quicker and in larger volumes increases as the burner size increases.

The small simmer burner is best used for simmering delicate sauces, etc. This burner is located at the right rear burner position on the cooktop (Figure 1). The standard burner can be used for most surface cooking needs. The standard burners are located at the left front and left rear positions on the cooktop (Figure 1).

The power burners are best used for bringing large quantities of liquid rapidly up to temperature or when preparing larger quantities of food. The POWER burner is located at the right front position on the cooktop.

Regardless of size, always select cookware that is suitable for the amount and type of food being prepared. Select a burner and flame size appropriate to the pan. Never allow flames to extend beyond the outer edge of the pan.

Assembly of the surface burner caps and burner grates

It is very important to make sure that all of the Surface Burner Caps and Surface Burner Grates are installed correctly and at the correct locations.

1. Remove all packing material from cooktop area.
2. Discard all packing material (if applicable).
3. Unpack Burner Grates and position on the cooktop.

→ IMPORTANT

Do not allow spills, food, cleaning agents or any other material to enter the gas orifice holder opening.

Always keep the Burner Caps and Burner Heads in place whenever the surface burners are in use.

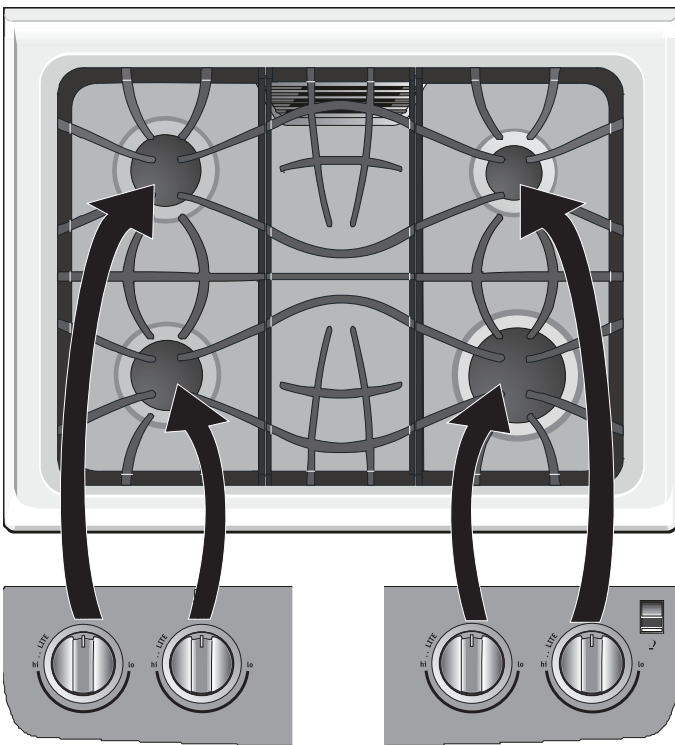

Figure 1: Burner locations

BEFORE SETTING SURFACE CONTROLS

Operating the gas surface controls

1. Place cooking utensil on surface burner.
2. Push the surface control knob down and turn counterclockwise out of the OFF position.
3. Release the knob and rotate to the LITE position (see figure 2). Note: All four electronic surface igniters will spark at the same time. However, only the burner you are turning on will ignite.
4. Visually check that the burner has a flame.
5. Turn the control knob counterclockwise to the desired flame size. The control knobs do not have to be set at a particular setting. Use the knob indicator settings to adjust the flame as needed. Do not cook with the surface control knob in the LITE position. (The electronic ignitor will continue to spark if the knob is left in the LITE position.)

! CAUTION

Do not place plastic items such as salt and pepper shakers, spoon holders, or plastic wrappings on top of the range when it is in use. These items could melt or ignite. Pot holders, towels, or wood spoons could catch fire if placed too close to a flame.

Do not operate the burner for an extended period of time without cookware on the grate. The finish on the grate may chip without cookware to absorb the heat.

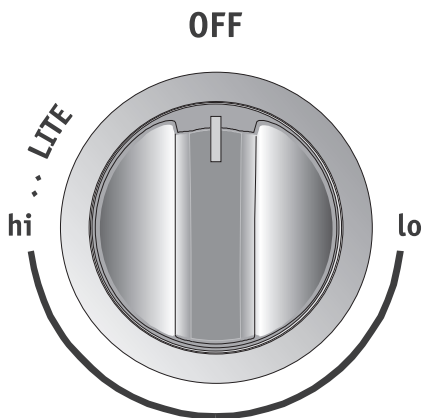

Figure 2: Gas knob LITE position

Setting proper surface burner flame size

For most cooking: Start on the highest control setting and then turn to a lower one to complete the process. Use the recommendations below as a guide for determining proper flame size for various types of cooking. The size and type of utensil used and the amount of food being cooked will influence the setting needed.

Flame Size	Type of Cooking
High Flame	<ul style="list-style-type: none"> • Start most foods • Bring water to a boil • Pan broiling
Medium Flame	<ul style="list-style-type: none"> • Maintain slow boil • Thicken sauces and gravies • Steaming foods
Low Flame	<ul style="list-style-type: none"> • Keep foods cooking, poaching, and stewing

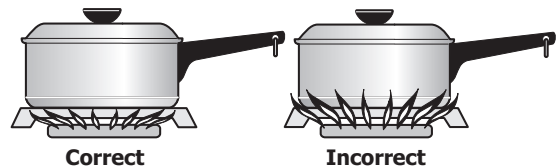

Figure 3: Gas flame adjustment

➔ IMPORTANT

Never extend the flame beyond the outer edge of the utensil. A higher flame simply wastes heat and energy, and increases the risk of being burned by the gas flame.

In the event of an electrical power outage, the surface burners can be lit manually. To light a surface burner, hold a lit match to the burner head, then slowly turn the surface control knob to LITE. After burner lights turn the knob to desired setting.

⚠ NOTE

Settings based on using medium weight metal or aluminum pans. Settings may vary using other types of pans. The color of the flame is key to proper burner adjustment. A good flame is clear, blue, and hardly visible in a well-lighted room. Each cone of the flame should be steady and sharp. Clean burner if flame is yellow-orange.

BEFORE SETTING OVEN CONTROLS

Oven vent location

The oven vent is located near the back of the cooktop. When the oven is on, warm air passes through this vent. This venting is necessary for proper air circulation in the oven and good baking results. Do not block oven vent.

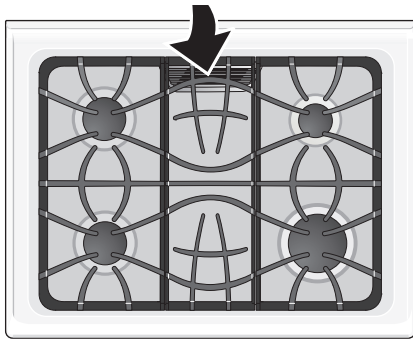

Figure 4: Do not block oven vent location

Removing, arranging and replacing racks

CAUTION

Always use pot holders or oven mitts when using the oven. When cooking, the oven interior and exterior, oven racks and cook top will become very hot which can cause burns.

WARNING

Protective Liners — Do not use aluminum foil to line the oven bottom. Only use aluminum foil as recommended in this manual. Improper installation of these liners may result in risk of electric shock or fire.

Removing, replacing, and arranging flat or offset oven racks

To arrange - Always arrange the oven racks when the oven is cool (prior to operating the oven).

To remove - Pull the oven rack straight forward until it reaches the stop position. Lift up front of oven rack slightly and slide out.

To replace - Place the oven rack on the rack guides on both sides of oven walls. Tilt the front of the oven rack upward slightly and slide the oven rack back into place. Be sure oven racks are level before using.

Types of oven racks

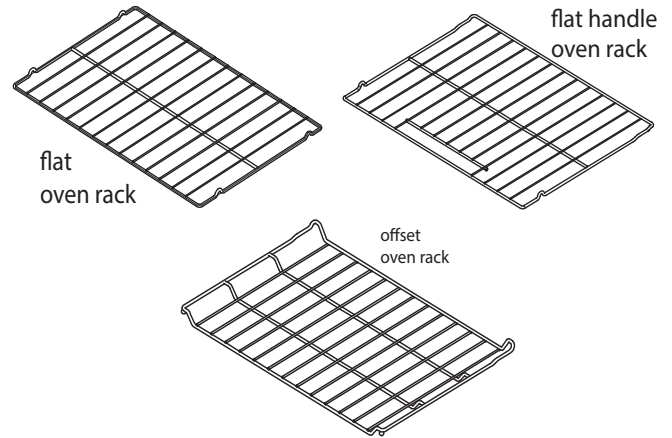

Figure 5: Oven rack types

Oven Rack Descriptions

- Flat oven racks (or the flat handle oven rack) may be used for most cooking needs and may be placed in most oven rack positions.
- The offset oven rack (some models) provides additional stepdown positions from the standard flat rack design. The offset design positions the base of the rack about 1/2 of a rack position lower than the flat rack and may be used in most oven rack positions.
- To maximize oven cooking space place the bottom oven rack (some models) in the lowest rack position for baking or roasting large cuts of meat.

Air circulation in the oven

For best air circulation when baking, allow a space of 2-4 inches (5-10 cm) around the cookware for proper air circulation. Be sure pans and cookware do not touch each other, the oven door, sides, or back of the oven cavity.

Hot air must be able to circulate around cookware for even heat to reach the food.

BEFORE SETTING OVEN CONTROLS

Oven racks and rack positions

➔ IMPORTANT

Remove all oven racks before starting a self-clean cycle. If oven racks are left inside the oven during a cleaning cycle, the slide ability of the oven racks may be damaged and all of the oven racks will lose their shiny finish. Clean oven racks according to the instructions provided in the Care & Cleaning section.

➔ IMPORTANT

To prevent possible damage to the oven, do not attempt to close the oven door until all the oven racks are fully positioned back inside the oven cavity.

⚠ CAUTION

Remove all oven racks and accessories before starting a self-clean cycle. If the oven racks are left in the oven during the self-clean cycle, the gliding ability of the oven racks will lose their shiny finish and may turn blue. Remove all oven racks and clean according to instructions provided in the Care & Cleaning section of this manual.

Make sure the oven and oven racks are completely cool. Never pick up hot oven racks or parts.

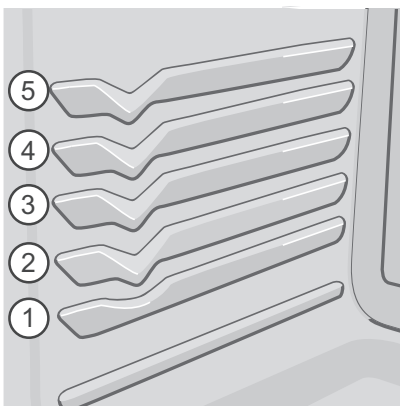
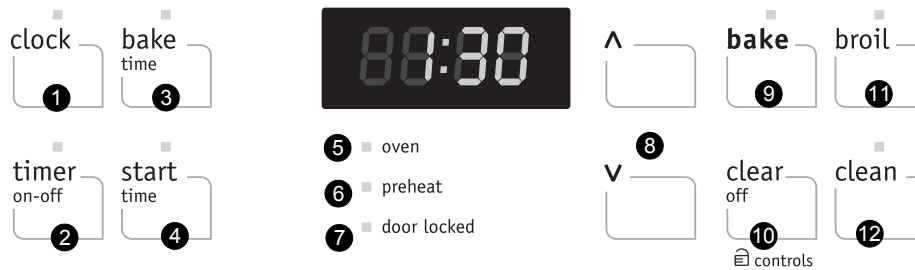

Figure 6: Rack positions

SETTING OVEN CONTROLS



READ THE INSTRUCTIONS CAREFULLY BEFORE USING THE OVEN.



For satisfactory use of your oven, become familiar with the various pad features and functions of the oven as described below.

1. **Clock** - Use to set the time of day.
2. **Timer on-off** - Use to set or cancel the minute timer. The minute timer does not start or stop any cooking function. Timer on-off is used to set the continuous bake function.
3. **Bake time** - Use to enter the length of baking time desired.
4. **Start time** - Use to set the desired start time for baking & self-clean. May be used with bake time to program a delayed timed bake.
5. **Oven light** - The oven light will glow each time the oven turns on to maintain the set oven temperature.
6. **Preheat light** - The preheat light will glow when the oven is first set to operate or if the desired temperature is reset higher than the actual oven temperature.
7. **Door locked** - The door locked light will flash when the oven door locks and unlocks, the oven door lockout is active or when the self-clean cycle feature is active.
8. **Up and Down arrows** - Use with the feature or function keys to set oven temperature, bake time, start time, clean time (when programming an automatic start time), setting or adjusting the clock and minute timer.
9. **Bake** - Use to select bake feature.
10. **Clear-off** - Use to clear any feature previously entered except the time of day and minute timer. Press clear off to stop cooking. Also use clear off to activate oven lockout feature.
11. **Broil** - Use to set broil feature.
12. **Clean** - Use to set self-clean cycle.

Setting the Clock

When the appliance is first plugged in or when the power supply to the appliance has been interrupted, the display will flash **12:00**. It is recommended to always set the clock for the correct time of day before using the appliance.

To set the clock

1. Press **clock** once (do not hold clock key down).
2. Within 5 seconds, press and hold the  or  until the correct time of day appears in the display.



NOTE

The clock cannot be changed when the oven is set for cooking or if self-clean is active.

Changing temperature display (°F or °C)

The electronic oven control is set to display °F (Fahrenheit) at the factory. The oven may be programmed for any temperature from 170°F to 550°F (77°C to 288°C).

To change the temperature to display °C (Celsius) or from °C to °F

1. Press **broil**. — — appears in the display.
2. Press and hold  until **HI** appears in the display.
3. Press and hold **broil** until °F or °C appears in the display.
4. Press the  or  to change °F to °C or °C to °F.
5. Press any control key to return to normal operating mode.



SETTING OVEN CONTROLS

Setting a silent control panel

When selecting a function, an audible tone is heard each time a key is pressed. If desired, the control can be programmed for silent operation. To set the controls for silent operation, press and hold **start time** for 6 seconds. The control will beep once, then release the key.

To return to non-silent operation, press and hold **start time** again for 6 seconds until the control beeps once.



Setting the minute timer

1. Press **timer on-off**.
2. Press  to increase time in one minute increments. Press and hold  to increase time in 10 minute increments. The timer can be set for any amount of time from 1 minute to 11 hours and 59 minutes.

Note: If  is pressed first, the timer will advance to 11 hours and 59 minutes.

3. When the set time ends, the timer will beep 3 times and will continue to beep 3 times every minute until timer on-off is pressed.

To change the timer while it is in use

While the timer is active and shows in the display, press and hold the  or  to increase or decrease the time remaining.

To cancel the minute timer before the set time has run out

Press **timer on-off** once.

NOTE

- The indicator light located above the timer on-off key will glow while the minute timer is active.
- The minute timer will display hours and minutes until 1 hour remains on the timer. Less than 1 hour, the display counts down in minutes and seconds. With less than 1 minute remaining only seconds will display.
- The minute timer will not start or stop the cooking process. The minute timer can be used alone or while using any of the other oven features. If another feature is active when the minute timer is active, the minute timer will show in the display. To view information about other active features, press the key for that feature.

Changing between continuous bake setting or 12-Hour Energy Saving feature

The oven control has a built-in 12-Hour Energy Saving feature that will shut off the oven if the oven is left on for more than 12 hours. The oven control can be programmed to override this feature for continuous baking.

Changing to continuous bake setting

1. Press and hold **timer on-off** down for 6 seconds until a tone sounds. **— — hr** will appear in display for continuous cooking. The current time of day will return to the display.
2. To cancel the continuous bake setting, press **timer on-off** and hold for 6 seconds until a tone sounds. **12 hr** will appear in display indicating that the control has returned to the 12-Hour Energy Saving feature.

IMPORTANT

Changing between continuous and 12 hour operation does not change how the cooktop controls operate.

Setting bake

Baking Tips:





- Preheat your oven before using the bake mode.
- Use only one rack and center the pans as much as possible on rack position 2 or 3. If using two racks, place the oven racks in positions 2 and 4.
- Allow 2" to 4" (5.1 to 10.2cm) around the utensil(s) for proper air circulation. Be sure the pans do not touch each other, the door, sides or back of the oven. [\(Figure 7\)](#)

The **bake** key controls normal baking. The oven can be programmed to bake at any temperature from 170°F to 550°F (77°C to 288°C).



The factory preset automatic bake temperature is 350°F (177°C).

SETTING OVEN CONTROLS

To set bake

1. Press **bake**. — — — appears in the display.
2. Within 5 seconds, press  or . The display will show **350°F** (177°C). The temperature can then be adjusted in 5°F increments by pressing and holding the  or  (1°C if the control is set in Celsius).
3. When the key is released, the oven will begin heating to the selected temperature. When the displayed temperature reaches the set temperature, the preheat indicator light will turn off and the control will beep 3 times.

To change oven temperature after bake has started

1. Press **bake**.
2. Press  or  to increase or decrease to a new temperature. The oven indicator light on the electronic display will turn on and off when using the bake feature and during preheat. This is normal and indicates that the oven is cycling to maintain the selected baking temperature. To cancel baking press **clear off**.

To change the bake temperature

1. After the oven has already been set to bake and the oven temperature needs to be changed, press **bake**. **UPPER** and **BAKE** will start flashing in the display.
2. Press **up** or **down arrow** to increase or decrease the set temperature.
3. **UPPER** and **BAKE** will stop flashing and remain in the display. A beep will sound once the oven temperature reaches the set baking temperature.

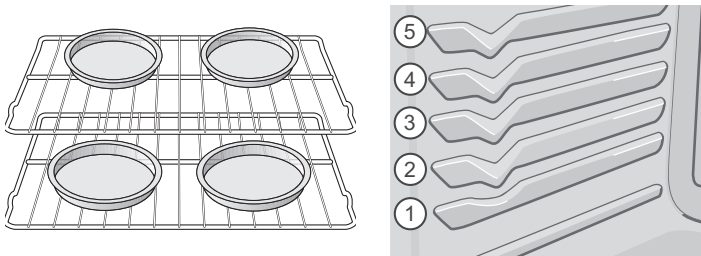

Figure 7: Pan spacing and rack positions







➔ IMPORTANT

Dark or dull pans absorb more heat than shiny bakeware resulting in dark or over browning of foods. It may be necessary to reduce the oven temperature or cook time to prevent over browning of some foods. Dark pans are recommended for pies. Shiny pans are recommended for cakes, cookies, and muffins.

Setting bake time

The bake time key sets the amount of time needed for baking. The oven will turn on immediately and stop automatically after the set bake time ends.

To program the oven to begin baking immediately and to shut off automatically (timed bake)

1. Be sure that the clock shows the correct time of day.
2. Place the food in the oven.
3. Press **bake**. — — — ° appears in the display.
4. Within 5 seconds, press the  or . The display will show **350°F** (177°C). The temperature can then be adjusted in 5°F increments by holding the  or  (1°C if the control is set to display Celsius).
5. Press **bake time**:00 will appear in the display.
6. Press the  or  until the desired baking time appears in the display.
7. The oven will turn on and begin heating.

Note: Bake time will not operate when using the broil feature.

⚠ WARNING

FOOD POISONING HAZARD. Do not let food sit for more than one hour before or after cooking. Doing so can result in food poisoning or sickness.

Use caution with the timed bake and delayed timed bake features. Foods that can easily spoil such as milk, eggs, fish, meat or poultry, should be chilled in the refrigerator first. Even when chilled, they should not stand in the oven for more than 1 hour before cooking begins, and should be removed promptly when cooking is finished.

Operating oven light

The interior oven light will automatically turn on when the oven door is opened. Press the oven light switch located on the upper right side of the control panel to turn the interior oven light on and off whenever the oven door is closed.







The interior oven light is located at the upper left rear wall of the oven interior and is covered with a glass shield. The glass shield must be in place whenever the oven is in use. To change the interior oven light, see Changing the oven light in the “[Care and Cleaning](#)” section.

SETTING OVEN CONTROLS

Setting bake time and start time

The bake time and start time keys may be used to set the length of baking time and to delay the starting time (delayed timed bake). The oven will turn on at a later time and stop automatically after the set bake time ends.

To program oven for a delayed start time and to shut-off automatically

1. Be sure that the clock displays the correct time of day.
2. Place food in the oven.
3. Press **bake**. $---$ ° appears in the display. Within 5 seconds, press the  or . The display will show 350°F (177°C). The temperature can then be adjusted in 5°F increments by holding the **Up arrow** or **Down arrow**, (1°C if the control is set for Celsius).
4. Press **bake time**.:00 will appear in the display.
5. Press  or  until desired baking time appears.
6. Press **start time**. The time of day will appear.
7. Press the  or  to reach desired start time.
8. Once the controls are set, the control calculates the time when baking will stop. The oven will turn on at the delayed start time and begin heating. The oven will turn off when the set bake time ends.

When the set bake time runs out



1. **End** will appear in the display and the oven will shut off automatically.
2. The control will beep 3 times every 60 seconds as a reminder until **clear off** is pressed.

Adjusting the oven temperature

Your appliance has been factory calibrated and tested to ensure an accurate baking temperature. For the first few uses, follow your recipe times and temperature recommendations carefully. If you think the oven is cooking too hot or too cool for your recipe times, you can adjust the control so the oven cooks hotter or cooler than the temperature displayed.

To adjust oven temperature

1. Press **bake**.
2. Set the temperature to 550°F (288°C) by pressing and holding .

3. Within 3 seconds, press and hold **bake** until numeric digit(s) appear. Release **bake** key. The display now indicates the amount of degrees offset between the original factory temperature setting and the current temperature setting. If the oven control has the original factory calibration, the display will read **0**.
4. The temperature can now be adjusted up or down 35°F (19°C), in 5°F increments. Press and hold  to adjust the temperature higher until the desired amount of offset appears in the display. When lowering the oven temperature using , a minus sign (-) will appear before the number to indicate that the oven will be cooler by the displayed amount of degrees.
5. When you have made the desired adjustment, press **clear off** to go back to the time of day display.

NOTE

- Oven temperature adjustments made will not affect the broil or self-cleaning feature temperatures.
- If the display is set for Celsius, adjustments made will be in 1°C increments each press of arrow keys.
- Do not use oven thermometers such as those found in grocery stores to check the temperature settings inside your oven. These oven thermometers may vary as much as 20 to 40 degrees from actual temperatures.

To set the oven lockout feature

1. Press **clear off** and hold for 3 seconds. **Loc** will appear in display, the **Door Locked** indicator light will flash and the motor driven door lock will begin to close automatically. Allow about 15 seconds for the oven door to lock. Once the oven door is locked, the current time of day will appear in the display.
2. To cancel the oven lockout feature, press **clear off** and hold for 3 seconds. The control will unlock the oven door and resume normal operation.

NOTE

Do not open the oven door while the indicator light is flashing. Allow about 15 seconds for the oven door to lock. Once the oven door is locked, the current time of day will appear in the display.

If any control key is pressed with the oven lockout feature active, **Loc** will appear in the display until the control key is released.

SETTING OVEN CONTROLS

Setting Broil

Use the broil feature to cook meats that require direct exposure to radiant heat for optimum browning results. When broiling always remember to arrange the oven racks while oven is still cool. Position the rack as suggested in the broil settings. (Table 1)

To set broil

1. Arrange the oven rack while oven is still cool.
2. Press **broil**. — — will appear in display.
3. Press for **HI** broil or for **LO** broil. Most foods may be broiled at the HI broil setting. Select the LO broil setting to avoid excess browning or drying of foods that should be cooked to the well-done stage.
4. For optimum results, preheat oven for 5 minutes before adding food.
5. Place the insert on the broil pan (if equipped), then place the food on the broil pan insert (if equipped).
6. Place the broiler pan and insert on the oven rack (Figure 8).
7. Broil on one side until food is browned. Turn and broil food on 2nd side.
8. When broiling is finished press **clear off**.
9. Always pull the oven rack out to the stop position before turning or removing food.

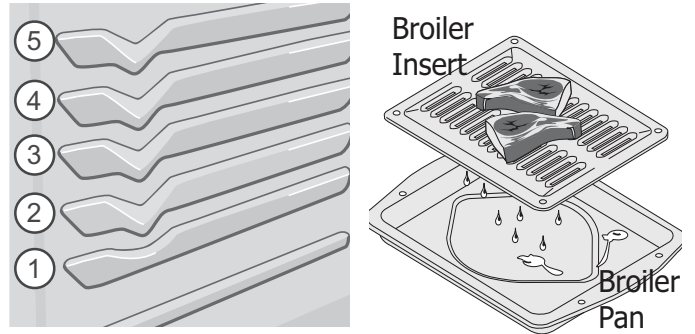

Figure 8: Rack positions (L) Broil pan and insert (R)

WARNING

Should an oven fire occur, close the oven door and turn the oven off. If the fire continues, use a fire extinguisher. Do not put water or flour on the fire. Flour may be explosive.

The broiler pan and the insert (Figure 8), provided with some models, allows grease to drain and be kept away from the high heat of the broiler. Do not use the pan without the insert. Do not cover the insert with aluminum foil; the exposed grease could ignite.

To insure proper results use only Electrolux Home Products, Inc. approved broil pan & insert.

Table 1: Suggested broil settings

Food item	Rack Position	Temperature	Cook time in minutes		Doneness
			1st side	2nd side	
Steak 1" thick	4th or 5th	Hi	8	6	Medium
Steak 1" thick	4th or 5th	Hi	10	8	Medium-well
Pork Chops 3/4 "thick	4th	Hi	12	8	Well
Chicken - Bone In	3rd	Lo	25	15	Well
Chicken Boneless	4th	Lo	10	8	Well
Fish	4th	Hi	-as directed		Well
Shrimp	3rd	Hi			-as directed
Hamburger 1" thick	5th	Hi	12	10	Medium
Hamburger 1" thick	4th	Hi	14	12	Well

SETTING OVEN CONTROLS

Self-Cleaning

A self-cleaning oven cleans itself with temperatures well above normal cooking temperatures which eliminate soils completely or reduces them to a fine powdered ash you can wipe away with a damp cloth

CAUTION

During the self-cleaning cycle, the outside of the range can become very hot to the touch. Do not leave small children unattended near the appliance.

The health of some birds is extremely sensitive to the fumes given off during the self-cleaning cycle of any range. Move birds to another well-ventilated room.

Do not force the oven door open. This can damage the automatic door locking system. Use caution when opening the door after the self-cleaning cycle is complete. The oven may still be very hot.

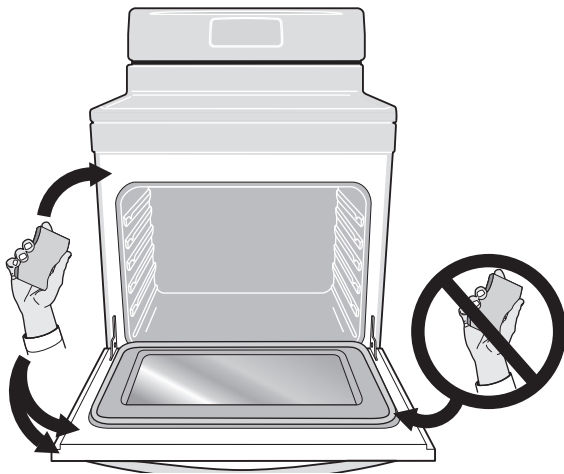

Figure 9: Areas to clean and avoid (gasket)

IMPORTANT

Adhere to the following self-clean precautions

- Do not use oven cleaners or oven protective coatings in or around any part of the oven interior.
- Do not clean the oven door gasket (Figure 9). The woven material of the oven door gasket is essential for a good seal. Care should be taken not to rub, damage or remove the gasket.
- Do not use any cleaning materials on the oven door gasket. Doing so could cause damage.
- Remove the broiler pan and insert, all utensils and any aluminum foil. These items cannot withstand high cleaning temperatures and will melt.
- Completely remove all oven racks and any accessories. If the oven racks are not removed they will lose their special coating properties and no longer slide in and out of the oven cavity easily.
- Remove any excessive spills. Any spills on the oven bottom should be wiped-up and removed before starting the self-cleaning cycle. To clean, use hot, soapy water and a cloth. Large spills can cause heavy smoke or fire when subjected to high temperatures.
- Do not allow food spills with a high sugar or acid content (such as milk, tomatoes, sauerkraut, fruit juices or pie filling) to remain on the surface as they may leave a dull spot even after cleaning.
- Clean any soil from the oven frame, the door liner outside the oven door gasket and the small area at the front center of the oven bottom. These areas heat sufficiently to burn soil on. Clean with soap and water. These areas are shown in white (Figure 9).



CAUTION

The oven bake and broil elements may still be hot after they appear to have cooled. Burns may occur if these elements are touched before they have cooled sufficiently.

For models with a visible lower bake element ONLY - This bake element was designed to be tilted up using your hand from the front of the bake element for cleaning purposes. Remove the bottom oven rack before raising the element. Do not to raise the element more than 4 or 5 inches from the resting position.

SETTING OVEN CONTROLS

Setting a self clean cycle

1. Be sure the clock displays the correct time of day.
2. Press **clean**. --- appears in the display.
3. Press  or  once. **3:00** will appear in the display indicating that a 3 hour self-clean time is set. To change to a 2 hour self-clean time press  once (2:00 appears in the display).

(Some models) For a 4 hour self-clean time press  until (4:00 appears in display).

As soon as the controls are set, the motor driven lock will begin to close automatically and the **DOOR LOCKED** indicator light will flash. Do not open the oven door while the light is flashing (allow about 15 seconds for the oven door to lock).

4. **CLn** will appear in the display during the self-clean cycle and the **DOOR LOCKED** light will glow until the self cleaning cycle is complete or cancelled and the oven temperature has cooled.

When the self-clean cycle has completed:

1. The time of day will appear in the display window and the Clean and **DOOR LOCKED** light will continue to glow.
2. Once the oven has cooled down for about 1 HOUR and the **DOOR LOCKED** light has gone out, the oven door can be opened.





Stopping or interrupting a self-clean cycle

If it becomes necessary to stop or interrupt a self cleaning cycle once it has been activated

1. Press **clear off**.
2. Once the oven has cooled down for about 1 HOUR and the **DOOR LOCKED** light has turned off, the oven door can be opened.

Restart the self-clean cycle once all conditions have been corrected.

Setting a delayed self clean cycle

1. Be sure the clock displays the correct time of day.
2. Press **start time**. The colon in the time of day will flash.
3. Press and hold  to scroll to the time to start the delayed self-clean cycle. Release the key when the desired time is displayed.
4. Press **clean**. --- appears in the display.
5. Press  or  once. **3:00** will appear in the display indicating that a 3 hour self-clean time is set. To change to a 2 hour self-clean time press  once (2:00 appears in the display).

(Some models) For a 4 hour self-clean time press  until (4:00 appears in display).

As soon as the controls are set, the motor driven lock will begin to close automatically and the **DOOR LOCKED** indicator light will flash. Do not open the oven door while the light is flashing (allow about 15 seconds for the oven door to lock).

6. **CLn** will appear in the display during the self-clean cycle and the **DOOR LOCKED** light will glow until the self cleaning cycle is complete or cancelled and the oven temperature has cooled.

CAUTION

- To avoid possible burns use care when opening the oven door after the self-cleaning cycle. Stand to the side of the oven when opening the door to allow hot air or steam to escape.
- Do not force the oven door open. This can damage the automatic door locking system. Use caution and avoid possible burns when opening the door after the self cleaning cycle has completed. The oven may still be very hot.

NOTE

Whenever the self-clean feature is active you may check the amount of time remaining in the self-clean cycle by pressing the clean key. Remember the range door cannot be opened until the range has cooled sufficiently. You will need to add about 1 hour to the time displayed before you can use the range for cooking.

When the oven is cool, wipe away any residue or powdered ash with a damp cloth or paper towel.

CARE AND CLEANING

Cleaning Various Parts of Your Wall Oven

Before cleaning any part of the oven, be sure all controls are turned off and the oven is cool. Remove spills and any heavy soiling as soon as possible. Regular cleaning will reduce the number of major cleaning later.

Surface Type	Recommendation
Aluminum and Vinyl	Use hot, soapy water and a cloth. Dry with a clean cloth.
Painted and plastic control knobs Painted body parts Painted decorative trims	Using a soft cloth, clean with mild dish detergent and water or a 50/50 solution of vinegar and water. Follow by rinsing the area with clean water; dry and polish with a soft cloth. Glass cleaners may be used if sprayed on a soft cloth first. Do not spray liquids directly on the oven control and display area. Do not use large amounts of water on the control panel - excess water on the control area may cause damage to the appliance. Do not use other liquid cleaners, abrasive cleaners, scouring pads, or paper towels - they will damage the finish. To remove control knobs, turn to the OFF position; grasp firmly and pull straight off the shaft. To replace knobs after cleaning, line up the flat sides of both the knob and the shaft; then push the knob into place.
Stainless Steel	Your oven finish may be made with stainless steel (some models). Clean the stainless with warm soapy water using a clean sponge or cloth. Rinse with clean water and dry with a soft clean cloth. Do not use any store bought cleaners like stainless steel cleaners or any other types of cleaners containing any abrasive, chlorides, chlorine, or ammonia. It is recommended to use mild dish soap and water or a 50/50 solution of water and vinegar.
Porcelain enamel broiler pan and insert (available by mail order) Door liner and body parts	Gentle scouring with a soapy scouring pad will remove most spots. Rinse with a 1:1 solution of clear water and ammonia. If necessary, cover difficult spots with an ammonia-soaked paper towel for 30 to 40 minutes. Rinse with clean water and a damp cloth, and then scrub with a soap-filled scouring pad. Rinse and wipe dry with a clean cloth. Remove all cleaners or the porcelain may become damaged during future heating.
Oven racks	Oven racks must be removed from oven cavity. Clean by using a mild, abrasive cleaner following manufacturer's instructions. Rinse with clean water and dry.
Oven door	Use soap and water to thoroughly clean the top, sides, and front of the oven door. Rinse well. You may use a glass cleaner on the outside glass of the door. Do not immerse the door in water. Do not spray or allow water or the glass cleaner to enter the door vents. Do not use oven cleaners, cleaning powders, or any harsh abrasive cleaning materials on the outside of the oven door. Do not clean the oven door gasket. On self-clean models, the oven door gasket is made of a woven material which is essential for a good seal. Care should be taken not to rub, damage, or remove this gasket.

CARE AND CLEANING

Removing and Replacing the Oven Door

⚠ CAUTION

The door is heavy. For safe, temporary storage, lay the door flat with the inside of the door facing down.

To remove oven door:

1. Open oven door completely horizontal with floor (See [Figure 10](#)).
2. Pull the door hinge locks on both left and right door hinges down from the oven frame completely towards the oven door (See [Figure 11](#)). A tool such as a small flat-blade screwdriver may be required.
3. Firmly grasp both sides of oven door along the door sides. Do not use the oven door handle (See [Figure 12](#)).
4. Close the door to approximately 10 degrees from the oven door frame.
5. Lift the oven door hinge arms over the roller pins located on each side of the oven frame (See [Figure 12](#)).

To replace oven door:

1. Firmly grasp both sides of oven door along the door sides. Do not use the oven door handle (See [Figure 12](#)).
2. Holding the oven door at the same angle as the removal position, seat the hook of the hinge arm over the roller pins located on each side of the oven door frame (See [Figure 12](#) and [Figure 13](#)). The hook of the hinge arms must be fully seated onto the roller pins.
3. Fully open the oven door, horizontal with floor See [Figure 10](#)).
4. Push the door hinge locks up towards and into the oven frame on both left and right oven door hinges to the locked position (See [Figure 11](#)).
5. Close the oven door.

➔ IMPORTANT

Special door care instructions - Most oven doors contain glass that can break. Do not close the oven door until all the oven racks are fully in place. Do not hit the glass with pots, pans, or any other object. Scratching, hitting, jarring, or stressing the glass may weaken its structure causing an increased risk of breakage at a later time.

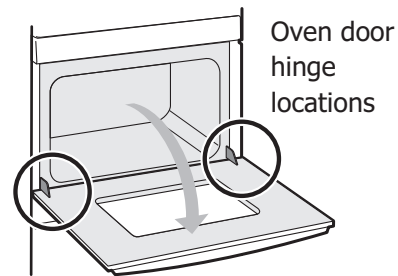

Figure 10: Door hinge location

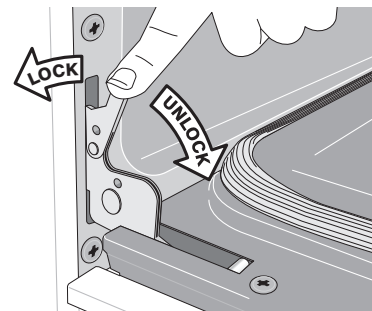

Figure 11: Door hinge locks

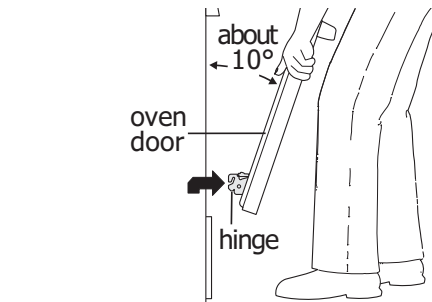

Figure 12: Holding door for removal

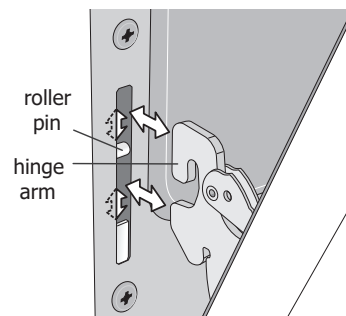

Figure 13: Replacement and location of hinge arm and roller pin

Replacing the oven light

CAUTION

Be sure the oven is unplugged and all parts are cool before replacing oven light.

The interior oven lights are located at the rear of the oven cavity and are covered with a glass shield. The glass shield must be in place whenever the oven is in use (See [Figure 14](#)).

Replacing the oven interior light bulb:

1. Turn electrical power off at the main source or unplug the appliance.
2. Remove interior oven light shield by turning a quarter turn.
3. Replace bulb with a new T-4 type Halogen 25 watt appliance bulb.

NOTE

Do not allow your fingers to touch the new bulb when replacing. This will shorten the life of the bulb. Use a paper towel or cotton glove while handling the new bulb when installing.

4. Replace glass oven light shield.
5. Turn power back on again at the main source (or plug the appliance back in).
6. Be sure to reset the time of day on the clock.

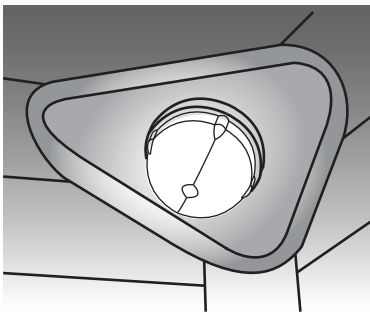

Figure 14: Halogen light





BEFORE YOU CALL

Solutions to Common Baking Problems

For best cooking results, heat the oven before baking cookies, breads, cakes, pies, or pastries, etc. There is no need to preheat the oven for roasting meat or baking casseroles.

The cooking times and temperatures needed to bake a product may vary slightly from your previously owned appliance.

Baking Problems and Solutions Chart

Baking Problems	Causes	Corrections
Cookies and biscuits burn on the bottom. 	<ul style="list-style-type: none"> • Cookies and biscuits put into oven before the preheating time is completed. • Oven rack is overcrowded. • Dark pans absorb heat too fast. 	<ul style="list-style-type: none"> • Allow oven to preheat to desired temperature before placing food in oven. • Choose pan sizes that will permit 2" to 4" of air space (5.1 cm to 10.2 cm) on all sides when placed in the oven. • Use a medium weight baking sheet.
Cakes too dark on top or bottom. 	<ul style="list-style-type: none"> • Cakes put in oven before preheating time is completed. • Rack position too high or too low. • Oven too hot. 	<ul style="list-style-type: none"> • Allow oven to preheat to the selected temperature before placing food in the oven. • Use proper rack position for baking needs. • Set oven temperature 25°F/12°C lower than recommended.
Cakes not done in center. 	<ul style="list-style-type: none"> • Oven too hot. • Incorrect pan size. • Pan not centered in oven. 	<ul style="list-style-type: none"> • Set oven temperature 25°F/12°C lower than recommended. • Use pan size suggested in recipe. • Use proper rack position and place pan to allow for 5.1 cm to 10.2 cm (2" to 4") of space on all sides of pan.
Cakes not level. 	<ul style="list-style-type: none"> • Range not level. • Pan too close to oven wall or rack overcrowded. • Pan warped. 	<ul style="list-style-type: none"> • Place a marked glass measuring cup filled with water on the center of the oven rack. If the water level is uneven, refer to the installation instructions for leveling the range. • Be sure to allow 5.1 cm to 10.2 cm (2" to 4") of clearance on all sides of each pan in the oven. • Do not use pans that are dented or warped.
Foods not done when cooking time is over. 	<ul style="list-style-type: none"> • Oven too cool. • Oven overcrowded. • Oven door opened too frequently. 	<ul style="list-style-type: none"> • Set oven temperature 25°F/12°C higher than suggested and bake for the recommended time. • Be sure to remove all pans from the oven except the ones to be used for baking. • Open oven door only after shortest recommended baking time.

Solutions to Common Problems

Before you call for service, review the following list. It may save you time and expense. Possible solutions are provided with the problem listed:

Problem	Solution
Poor baking results	Many factors determine baking results. Use proper oven rack position. Center food in the oven and space pans to allow air to circulate. Preheat oven to the set temperature before placing food in the oven. Try adjusting the recipe's recommended temperature or baking time. See "Adjusting the oven temperature" on page 15 if you feel the oven is too hot or cold.
Appliance is not level	Be sure floor is level, strong and stable enough to adequately support range. If floor is sagging or sloping, contact a carpenter to correct the situation. Poor installation. Place oven rack in center of oven and place a level on the oven rack. Adjust leveling legs at base of appliance until the rack is level. Kitchen cabinet alignment may make range appear not level. Be sure cabinets are square and have sufficient room for appliance clearance.
Cannot move appliance easily. Appliance must be accessible for service.	Cabinets not square or are built in too tight to allow clearance for appliance. Contact builder or installer to make appliance accessible. Carpet interferes with appliance. Provide sufficient space so appliance can be lifted over carpet.
Entire appliance does not work.	For models with a power cord, make sure power cord is plugged properly into outlet. If electricity to home is working, check fuse box or breaker. Call your local electric company for service outage information. Service wiring is not complete. Call 1-800-4-MY-HOME® for assistance.
Oven portion does not operate.	The time of day is not set. The oven clock must first be set in order to operate the oven. See "Setting the Clock" on page 12 Be sure oven controls are set properly. See "Oven Control Functions" on page 14 and review instructions for the desired cooking function in this manual or see "Entire appliance does not operate" in this checklist.
Oven light does not work.	Be sure the oven light is secure in the socket. See "Replacing the oven light" on page 21 .
Cooking zones do not glow when heating.	Induction cooking zones will not glow when in use. Induction cooking uses electromagnetic energy to induce heat directly to the cookware.
Flames inside oven or smoking from oven vent.	Excessive spills in oven. Grease or food spilled onto oven bottom or oven cavity. Wipe up excessive spills before starting oven. If flames or excessive smoke are present when using Broil, see "Setting Broil" page 16 .
Self Clean does not work.	Oven control not set properly. Review instructions in "Self-Cleaning" section. (page 17)
Oven racks discolored or do not slide easily.	Oven racks left in oven cavity during self clean. Always remove oven racks from oven cavity before starting a self-clean cycle. Clean by using a mild abrasive cleaner following manufacturer's instructions. Rinse with clean water, dry, and replace in oven.

BEFORE YOU CALL

Oven smokes excessively when broiling.	<p>Incorrect setting. Follow broiling instructions in Setting Oven Controls section.</p> <p>Meat too close to the broil element. Reposition broil rack to provide proper clearance between the meat and broil element. Remove excess fat from meat. Cut remaining fatty edges to prevent curling, but do not cut into lean.</p> <p>Grease build up on oven surfaces. Regular cleaning is necessary when broiling frequently. Grease or food splatters will cause excessive smoking.</p>
Oven control panel beeps and displays any F or E code error.	<p>Oven control has detected a fault or error condition. Press clear off key to clear the error code. Try bake or broil function. If the F or E code error repeats, turn OFF power to appliance, wait 5 minutes and then repower appliance. Set clock with correct time of day. Try bake or broil function again. If fault recurs, press Clear off to clear and call 1-800-4-MY-HOME® for assistance.</p>
Soil not completely removed after Self Clean.	<p>Self Clean was interrupted. Review instructions in Self Clean section.</p> <p>Excessive spills on oven bottom. Clean before starting Self Clean.</p> <p>Failure to clean soil from the oven frame, the door liner outside the oven door gasket and the small area at the front center of the oven bottom. These areas are not in the self-cleaning area, but get hot enough to burn on residue. Clean these areas before starting the self-cleaning cycle. Burned-on residue can be cleaned with a stiff nylon brush and water or a nylon scrubber. Be careful not to damage the oven gasket.</p>
Convection fan does not rotate.	<p>Oven door is open. Convection fan will turn off if oven door is opened when Convection is active. Close oven door.</p>
Oven racks discolored or do not slide easily.	<p>Oven racks left in oven cavity during Self Clean. Always remove oven racks from oven cavity before starting a self-clean cycle. Clean by using a mild abrasive cleaner following manufacturer's instructions. Rinse with clean water, dry, and replace in oven.</p>
Self Clean does not work.	<p>Oven control not set properly. Review instructions in Self Clean section.</p>

Your appliance is covered by a one year limited warranty. For one year from your original date of purchase, Electrolux will pay all costs for repairing or replacing any parts of this appliance that prove to be defective in materials or workmanship when such appliance is installed, used and maintained in accordance with the provided instructions.

Exclusions

This warranty does not cover the following:

1. Products with original serial numbers that have been removed, altered or cannot be readily determined.
2. Product that has been transferred from its original owner to another party or removed outside the USA or Canada.
3. Rust on the interior or exterior of the unit.
4. Products purchased "as-is" are not covered by this warranty.
5. Food loss due to any refrigerator or freezer failures.
6. Products used in a commercial setting.
7. Service calls which do not involve malfunction or defects in materials or workmanship, or for appliances not in ordinary household use or used other than in accordance with the provided instructions.
8. Service calls to correct the installation of your appliance or to instruct you how to use your appliance.
9. Expenses for making the appliance accessible for servicing, such as removal of trim, cupboards, shelves, etc., which are not a part of the appliance when it is shipped from the factory.
10. Service calls to repair or replace appliance light bulbs, air filters, water filters, other consumables, or knobs, handles, or other cosmetic parts.
11. Surcharges including, but not limited to, any after hour, weekend, or holiday service calls, tolls, ferry trip charges, or mileage expense for service calls to remote areas, including the state of Alaska.
12. Damages to the finish of appliance or home incurred during installation, including but not limited to floors, cabinets, walls, etc.
13. Damages caused by: services performed by unauthorized service companies; use of parts other than genuine Electrolux parts or parts obtained from persons other than authorized service companies; or external causes such as abuse, misuse, inadequate power supply, accidents, fires, or acts of God.

DISCLAIMER OF IMPLIED WARRANTIES; LIMITATION OF REMEDIES

CUSTOMER'S SOLE AND EXCLUSIVE REMEDY UNDER THIS LIMITED WARRANTY SHALL BE PRODUCT REPAIR OR REPLACEMENT AS PROVIDED HEREIN. CLAIMS BASED ON IMPLIED WARRANTIES, INCLUDING WARRANTIES OF MERCHANTABILITY OR FITNESS FOR A PARTICULAR PURPOSE, ARE LIMITED TO ONE YEAR OR THE SHORTEST PERIOD ALLOWED BY LAW, BUT NOT LESS THAN ONE YEAR. ELECTROLUX SHALL NOT BE LIABLE FOR CONSEQUENTIAL OR INCIDENTAL DAMAGES SUCH AS PROPERTY DAMAGE AND INCIDENTAL EXPENSES RESULTING FROM ANY BREACH OF THIS WRITTEN LIMITED WARRANTY OR ANY IMPLIED WARRANTY. SOME STATES AND PROVINCES DO NOT ALLOW THE EXCLUSION OR LIMITATION OF INCIDENTAL OR CONSEQUENTIAL DAMAGES, OR LIMITATIONS ON THE DURATION OF IMPLIED WARRANTIES, SO THESE LIMITATIONS OR EXCLUSIONS MAY NOT APPLY TO YOU. THIS WRITTEN WARRANTY GIVES YOU SPECIFIC LEGAL RIGHTS. YOU MAY ALSO HAVE OTHER RIGHTS THAT VARY FROM STATE TO STATE.

If You Need Service

Keep your receipt, delivery slip, or some other appropriate payment record to establish the warranty period should service be required. If service is performed, it is in your best interest to obtain and keep all receipts. Service under this warranty must be obtained by contacting Electrolux at the addresses or phone numbers below.

This warranty only applies in the USA and Canada. In the USA, your appliance is warranted by Electrolux Major Appliances North America, a division of Electrolux Home Products, Inc. In Canada, your appliance is warranted by Electrolux Canada Corp. Electrolux authorizes no person to change or add to any obligations under this warranty. Obligations for service and parts under this warranty must be performed by Electrolux or an authorized service company. Product features or specifications as described or illustrated are subject to change without notice.

USA
1.800.944.9044
Electrolux Home Products, Inc.
10200 David Taylor Drive
Charlotte, NC 28262



Canada
1.800.265.8352
Electrolux Canada Corp.
5855 Terry Fox Way
Mississauga, Ontario, Canada
L5V 3E4