

FRIGIDAIRE

All about the

Use & Care

of your Compact Refrigerator



TABLE OF CONTENTS

Important Safety Instructions.....	2	Care and Cleaning	6
Installation	4	Door Reversal Instructions	7
Energy Saving Tips	4	Before you Call.....	8
Temperature Controls	5	Major Appliance Warranty	10
Features	5		

SERIAL/MODEL #'S - IMPORTANT SAFETY INSTRUCTIONS

Read and Save These Instructions

This Owner's Guide provides specific operating instructions for your model. Use your refrigerator only as instructed in this guide. These instructions are not meant to cover every possible condition and situation that may occur. Common sense and caution must be practiced when installing, operating, and maintaining any appliance.

Record Your Model and Serial Numbers

Record the model and serial numbers in the space provided below. The serial plate is located on the upper left wall inside the refrigerator or on back of the unit.

Model Number: _____

Serial Number: _____

Purchase Date: _____

WARNING

Please read all instructions before using this refrigerator.

DANGER



DANGER Risk of fire or explosion. Flammable refrigerant used. Do not use mechanical devices to defrost refrigerator. Do not puncture refrigerant tubing.

DANGER Risk of fire or explosion. Flammable refrigerant used. To be repaired only by trained service personnel. Do not puncture refrigerant tubing.

CAUTION



CAUTION Risk of fire or explosion. Flammable refrigerant used. Consult repair manual/ owner's guide before attempting to service this product. All safety precautions must be followed.

CAUTION Risk of fire or explosion. Dispose of property in accordance with federal or local regulations. Flammable refrigerant used.

CAUTION- Risk of fire or explosion due to puncture of refrigerant tubing ;Follow handling instructions carefully. Flammable refrigerant used.

Definitions

 This is the safety alert symbol. It is used to alert you to potential personal injury hazards. Obey all safety messages that follow this symbol to avoid possible injury or death.

DANGER

DANGER indicates an imminently hazardous situation which, if not avoided, will result in death or serious injury.

WARNING

WARNING indicates a potentially hazardous situation which, if not avoided, could result in death or serious injury.

CAUTION

CAUTION indicates a potentially hazardous situation which, if not avoided, may result in minor or moderate injury.

IMPORTANT

IMPORTANT indicates installation, operation or maintenance information which is important but not hazard-related.

WARNING

For Your Safety

Do not store or use gasoline, or other flammable vapors and liquids in the vicinity of this or any other appliance. Read product labels for flammability and other warnings.

IMPORTANT SAFETY INSTRUCTIONS

WARNING

Electrical Information

- **The refrigerator must be plugged into its own dedicated 115 Volt, 60 Hz., 15 Amp, AC only electrical outlet.** The power cord of the appliance is equipped with a three-prong grounding plug for your protection against electrical shock hazards. It must be plugged directly into a properly grounded three prong receptacle. The receptacle must be installed in accordance with local codes and ordinances. Consult a qualified electrician. Avoid connecting refrigerator to a Ground Fault Interruptor (GFI) circuit. **Do not use an extension cord or adapter plug.**
- If the power cord is damaged, it should be replaced by an authorized service technician to prevent any risk.
- Never unplug the refrigerator by pulling on the power cord. Always grip the plug firmly, and pull straight out from the receptacle to prevent damaging the power cord.
- Unplug the refrigerator before cleaning and before replacing a light bulb to avoid electrical shock.
- Performance may be affected if the voltage varies by 10% or more. Operating the refrigerator with insufficient power can damage the compressor. Such damage is not covered under your warranty.
- Do not plug the unit into an electrical outlet controlled by a wall switch or pull cord to prevent the refrigerator from being turned off accidentally.

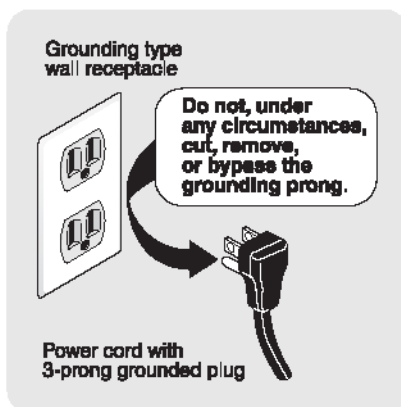

WARNING

Child Safety

- Destroy carton, plastic bags, and any exterior wrapping material immediately after the refrigerator is unpacked. Children should never use these items to play. Cartons covered with rugs, bedspreads, plastic sheets or stretch wrap may become airtight chambers, and can quickly cause suffocation.
- Remove all staples from the carton. Staples can cause severe cuts, and destroy finishes if they come in contact with other appliances or furniture.
- An empty, discarded refrigerator is a very dangerous attraction to children.
- Remove the door(s) of any appliance that is not in use, even if it is being discarded.

WARNING

Proper Disposal of your Refrigerator

Risk of child entrapment

Child entrapment and suffocation are not problems of the past. Junked or abandoned refrigerators are still dangerous – even if they will sit for “just a few days”. If you are getting rid of your old refrigerator, please follow the instructions below to help prevent accidents.

We strongly encourage responsible appliance recycling/disposal methods. Check with your utility company or visit www.energystar.gov/recycle for more information on recycling your old refrigerator.

Before you throw away your old refrigerator:

- Remove doors.
- Leave shelves in place so children may not easily climb inside.
- Have refrigerant removed by a qualified service technician.

INSTALLATION

This Use & Care Guide provides general operating instructions for your model. Use the refrigerator only as instructed in this Use & Care Guide. **Before starting the refrigerator, follow these important first steps.**

Location

- Choose a place that is near a grounded electrical outlet. **Do Not** use an extension cord or an adapter plug.
- For the most efficient operation, the refrigerator should be located where surrounding temperatures will not drop below 50°F (10°C) or exceed 110°F (43°C).
- Allow space around the unit for good air circulation. Leave a 4 inch (101.6 mm) space on the back and 3 inches (76.2 mm) on the sides and back of the refrigerator for adequate circulation.

NOTE

The exterior walls of the refrigerator may become quite warm as the compressor works to transfer heat from the inside. Temperatures as much as 30°F (-1°C) warmer than room temperature can be expected. For this reason it is particularly important in hotter climates to allow enough space for air circulation around your refrigerator.

Leveling

The refrigerator must have all bottom corners resting firmly on solid floor. The floor must be strong enough to support a fully loaded refrigerator. **NOTE:** It is Very Important for your refrigerator to be level in order to function properly. If the refrigerator is not leveled during installation, the door may be misaligned and not close or seal properly, causing cooling, frost, or moisture problems.

To Level Your Refrigerator:

After removing all interior and exterior packaging materials, use a carpenter's level to level the refrigerator from front-to-back. Adjust the plastic leveling feet in front, ½ bubble higher, so that the door closes easily when left halfway open.

ENERGY SAVING TIPS

Cleaning

- Wash any removable parts of the refrigerator interior, and exterior with mild detergent and warm water. Wipe dry. Do not use harsh cleaners on these surfaces.
- Do not use razor blades or other sharp instruments, which can scratch the appliance surface when removing adhesive labels. Any glue left from the tape can be removed with a mixture of warm water and mild detergent, or touch the residue with the sticky side of tape already removed. Do not remove the serial plate.

CAUTION

To allow door to close and seal properly, **DO NOT** let food packages extend past the front of shelves.

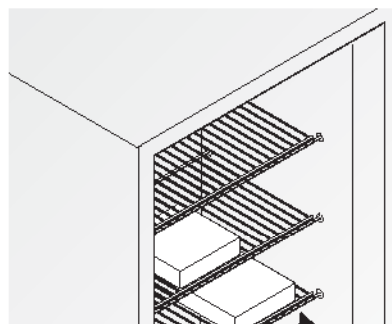

Shelf Front

ENERGY SAVING TIPS

- Install the refrigerator in the coolest part of a dry and ventilated room, out of direct sunlight and away from heating ducts or registers. Do not place the refrigerator next to heat-producing appliances such as a range, oven or dishwasher.
- Level the refrigerator so the door closes tightly.
- Do not overcrowd the refrigerator or block cold air vents. Doing so causes the refrigerator to run longer and use more energy. Shelves should not be lined with aluminum foil, wax paper or paper toweling. Liners interfere with cold air circulation, making the unit less efficient.
- Wipe bottles and containers dry before placing them in the refrigerator. This cuts down on moisture build-up inside the unit.
- Organize the refrigerator to reduce door openings. Remove as many items as needed at one time and close the door as soon as possible.

Single Door Model

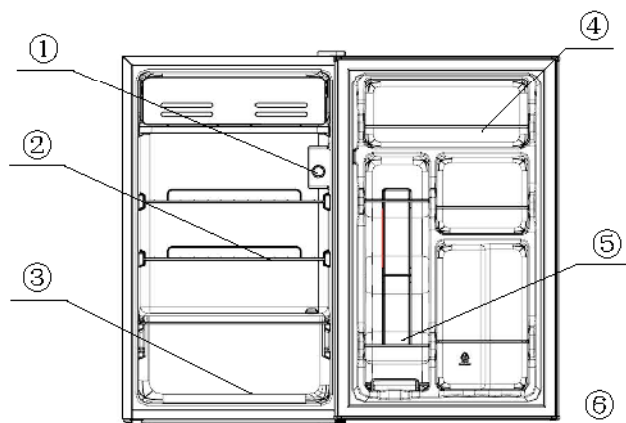

- 1 Thermostat
- 2 Glass shelf (2)
- 3 Crisper
- 4 Door rack
- 5 Can rack
- 6 Adjustable foot

Adjustable Interior Shelves

Multi-position adjustable interior shelves can be moved to any position for larger or smaller bottles. The shipping spacers that stabilize the shelves for shipping should be removed and discarded.

Slide-Out Crisper (Some Models)

A Slide-Out Basket (some models) located at the bottom of the refrigerator, provides separate storage space for **items that are difficult to store on refrigerator shelves.** To remove the basket, pull out and lift up.

Interior Light (Some models)

The light comes on automatically when the door is opened. To replace the light bulb, turn the temperature control to OFF and unplug the electrical cord. Replace the old bulb with a bulb of the same wattage.

Cleaning the Inside

Wash inside surfaces of the refrigerator with a solution of two tablespoons of baking soda in one quart (1.136 liters) warm water. Rinse and dry. Wring excess water out of the sponge or cloth when cleaning in the area of the controls, or any electrical parts.

Wash the removable parts with the baking soda solution mentioned above, or mild detergent and warm water. Rinse and dry. Never use metallic scouring pads, brushes, abrasive cleaners, or alkaline solutions on any surface. Do not wash removable parts in a dishwasher.

Cleaning the Outside

Wash the cabinet with warm water and mild liquid detergent. Rinse well and wipe dry with a clean soft cloth.

Vacation and Moving Tips

Vacations:

If the refrigerator will not be used for several months:

- Remove all food and unplug the power cord.
- Clean and dry the interior thoroughly.
- Leave the refrigerator door open slightly, blocking it open if necessary, to prevent odor and mold growth.

Moving: When moving the refrigerator, follow these guidelines to prevent damage:

- Disconnect the power cord plug from the wall outlet.
- Remove food and clean the refrigerator.
- Secure all loose items by taping them securely in place to prevent damage.
- In a moving vehicle, secure the refrigerator in an upright position to prevent movement. Also, protect the outside of the refrigerator with a blanket or similar item.

DOOR REVERSAL INSTRUCTIONS

Reversing the door swing should be performed by a qualified person. Before you begin, ensure that the appliance is unplugged and empty. Adjust the two leveling legs on the front of the refrigerator to their highest level by turning counter clockwise. It is recommended that two (2) people perform this task.

TOOLS REQUIRED

- Phillips Head Screwdriver
- Flat bladed screwdriver

Note: To remove the door it is necessary to tilt the appliance backward.

You should rest the refrigerator against a stable, solid object and place something under the rear rollers so that it will not slip during the door reversal process.

DO NOT lay the appliance completely flat as this may damage the coolant system.

First Step

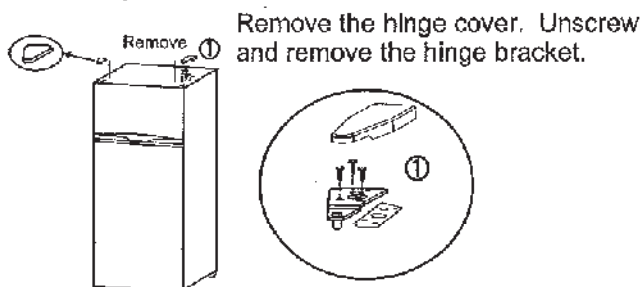

Second Step

Lift the freezer door up and away from the appliance.

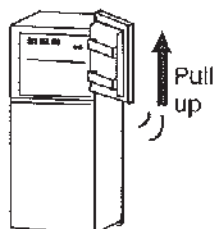

Third Step

Remove the screws from the middle hinge. Lift the refrigerator door up and away from the appliance.

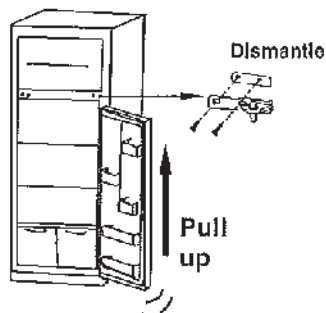

Fourth Step

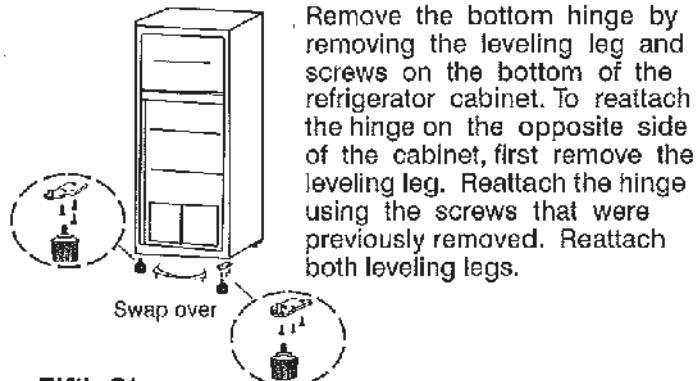

Remove the bottom hinge by removing the leveling leg and screws on the bottom of the refrigerator cabinet. To reattach the hinge on the opposite side of the cabinet, first remove the leveling leg. Reattach the hinge using the screws that were previously removed. Reattach both leveling legs.

Fifth Step

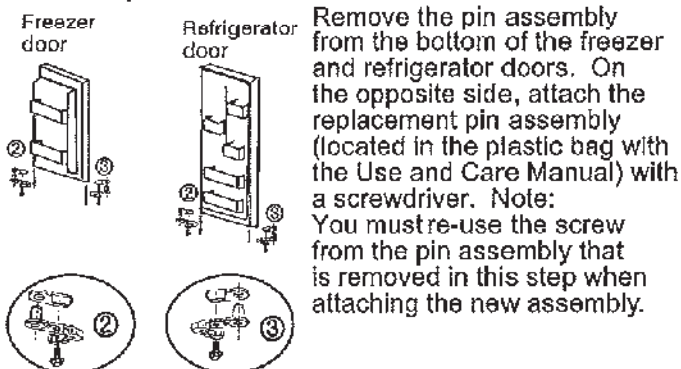

Remove the pin assembly from the bottom of the freezer and refrigerator doors. On the opposite side, attach the replacement pin assembly (located in the plastic bag with the Use and Care Manual) with a screwdriver. Note: You must re-use the screw from the pin assembly that is removed in this step when attaching the new assembly.

Sixth Step

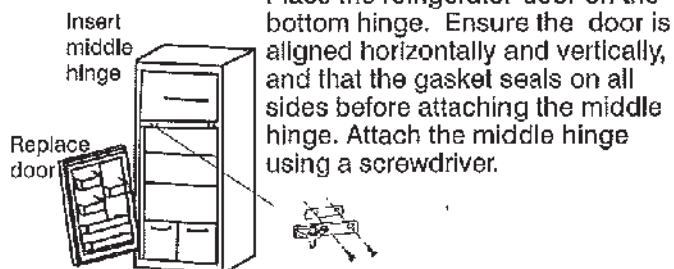

Place the refrigerator door on the bottom hinge. Ensure the door is aligned horizontally and vertically, and that the gasket seals on all sides before attaching the middle hinge. Attach the middle hinge using a screwdriver.

Seventh Step

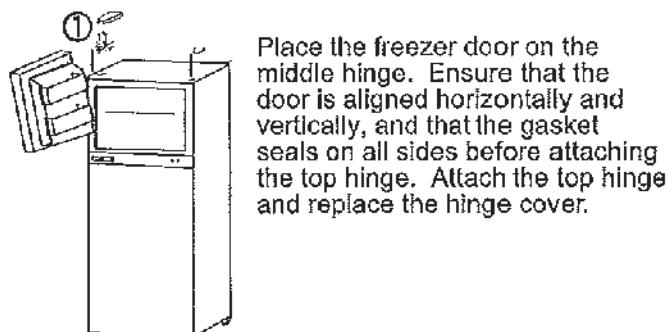

Place the freezer door on the middle hinge. Ensure that the door is aligned horizontally and vertically, and that the gasket seals on all sides before attaching the top hinge. Attach the top hinge and replace the hinge cover.

IMPORTANT:

Double check that both doors are aligned correctly and gaskets are sealed on all sides. If necessary, re-adjust the leveling legs.

BEFORE YOU CALL

1-800-944-9044 (United States)
1-800-265-8352 (Canada)

Visit our web site at
www.frigidaire.com.

PROBLEM	CAUSE	CORRECTION
REFRIGERATOR OPERATION		
Refrigerator does not run.	<ul style="list-style-type: none"> • Refrigerator is plugged into a circuit that has a ground fault interrupt. • Temperature control is in the OFF position. • Refrigerator may not be plugged in, or plug may be loose. • House fuse blown or tripped circuit breaker. • Power outage. 	<ul style="list-style-type: none"> • Use another circuit. If you are unsure about the outlet, have it checked by a certified technician. • See Setting the Temperature Control section. • Ensure plug is tightly pushed into outlet. • Check/replace fuse with a 15 amp time-delay fuse. Reset circuit breaker. • Check house lights. Call local Electric Company.
Refrigerator runs too much or too long.	<ul style="list-style-type: none"> • Room or outside weather is hot. • Refrigerator has recently been disconnected for a period of time. • Large amounts of warm or hot food has been stored recently. • Door is opened too frequently or too long. • Refrigerator door may be slightly open. • Temperature control is set too low. • Refrigerator gasket is dirty, worn, cracked, or poorly fitted. 	<ul style="list-style-type: none"> • It's normal for the Refrigerator to work harder under these conditions. • It takes 4 hours for the Refrigerator to cool down completely. • Warm food will cause Refrigerator to run more until the desired temperature is reached. • Warm air entering the Refrigerator causes it to run more. Open doors less often. • See "DOOR PROBLEMS" section. • Turn control knob to a warmer setting. Allow several hours for the temperature to stabilize. • Clean or change gasket. Leaks in the door seal will cause Refrigerator to run longer in order to maintain desired temperature.
Interior Refrigerator temperature is too cold.	<ul style="list-style-type: none"> • Temperature control is set too low. 	<ul style="list-style-type: none"> • Turn the control to a warmer setting. Allow several hours for the temperature to stabilize.
Interior Refrigerator temperature is too warm.	<ul style="list-style-type: none"> • Temperature control is set too warm. • Door is opened too frequently or too long. • Door may not be seating properly. • Large amounts of warm or hot food has been stored recently. • Refrigerator has recently been disconnected for a period of time. 	<ul style="list-style-type: none"> • Turn control to a colder setting. Allow several hours for the temperature to stabilize. • Warm air entering the Refrigerator causes it to run more. Open doors less often. • See "DOOR PROBLEMS" section. • Warm food will cause Refrigerator to run more until the desired temperature is reached. • It takes 4 hours for the Refrigerator to cool down completely.
Refrigerator external surface temperature is warm.	<ul style="list-style-type: none"> • The external Refrigerator walls can be as much as 30°F warmer than room temperature. 	<ul style="list-style-type: none"> • This is normal while the compressor works to transfer heat from inside the Refrigerator cabinet.
SOUND AND NOISE		
Louder sound levels when Refrigerator is on.	<ul style="list-style-type: none"> • Modern refrigerators have increased storage capacity and more stable temperatures. They require a high efficiency compressor 	<ul style="list-style-type: none"> • This is normal. When the surrounding noise level is low, you might hear the compressor running while it cools the interior.

BEFORE YOU CALL (continued)

PROBLEM	CAUSE	CORRECTION
SOUND AND NOISE (continued)		
Longer sound levels when compressor comes on.	<ul style="list-style-type: none"> Refrigerator operates at higher pressures during the start of the ON cycle. 	<ul style="list-style-type: none"> This is normal. Sound will level off or disappear as Refrigerator continues to run.
Popping or cracking sound when compressor comes on.	<ul style="list-style-type: none"> Metal parts undergo expansion and contraction, as in hot water pipes. 	<ul style="list-style-type: none"> This is normal. Sound will level off or disappear as Refrigerator continues to run.
Boiling or gurgling sound, like water boiling.	<ul style="list-style-type: none"> Refrigerant (used to cool Refrigerator) is circulating throughout the system. 	<ul style="list-style-type: none"> This is normal.
Vibrating or rattling noise.	<ul style="list-style-type: none"> Refrigerator is not level. It rocks on the floor when it is moved slightly. 	<ul style="list-style-type: none"> Level the unit. Refer to leveling instructions in the "Installation" section.
Snapping sound.	<ul style="list-style-type: none"> Cold control turning the Refrigerator OFF and ON. 	<ul style="list-style-type: none"> This is normal.
WATER/MOISTURE/FROST INSIDE REFRIGERATOR		
Moisture forms on inside of Refrigerator walls.	<ul style="list-style-type: none"> Weather is hot and humid. Door may not be seating properly. Door is kept open too long, or opened too frequently. 	<ul style="list-style-type: none"> This is normal. See "DOOR PROBLEMS" section. Open the door less often.
WATER/MOISTURE/FROST OUTSIDE REFRIGERATOR		
Moisture forms on outside of Refrigerator.	<ul style="list-style-type: none"> Door may not be seating properly, causing the cold air from inside the unit to meet warm moist air from outside. 	<ul style="list-style-type: none"> See "DOOR PROBLEMS" section.
ODOR IN REFRIGERATOR		
Odors in Refrigerator.	<ul style="list-style-type: none"> Interior needs to be cleaned. 	<ul style="list-style-type: none"> Clean interior with sponge, warm water, and baking soda.
DOOR PROBLEMS		
Door will not close.	<ul style="list-style-type: none"> Refrigerator is not level. It rocks on the floor when it is moved slightly. 	<ul style="list-style-type: none"> This condition may force the cabinet out of square and misalign the door. Refer to "Leveling" in the "Installation" section.
LIGHT BULB IS NOT ON		
Light bulb is not on.	<ul style="list-style-type: none"> Light bulb is burnt out. No electric current is reaching the refrigerator. 	<ul style="list-style-type: none"> Follow instructions under "Interior Light" in the "FEATURES" section. See "Installation" section.

MAJOR APPLIANCE WARRANTY

Your appliance is covered by a one year limited warranty. For one year from your original date of purchase, Electrolux will pay all costs for repairing or replacing any parts of this appliance that prove to be defective in materials or workmanship when such appliance is installed, used and maintained in accordance with the provided instructions.

Exclusions **This warranty does not cover the following:**

1. Products with original serial numbers that have been removed, altered or cannot be readily determined.
2. Product that has been transferred from its original owner to another party or removed outside the USA or Canada.
3. Rust on the interior or exterior of the unit.
4. Products purchased "as-is" are not covered by this warranty.
5. Food loss due to any refrigerator or freezer failures.
6. Products used in a commercial setting.
7. Service calls which do not involve malfunction or defects in materials or workmanship, or for appliances not in ordinary household use or used other than in accordance with the provided instructions.
8. Service calls to correct the installation of your appliance or to instruct you how to use your appliance.
9. Expenses for making the appliance accessible for servicing, such as removal of trim, cupboards, shelves, etc., which are not a part of the appliance when it is shipped from the factory.
10. Service calls to repair or replace appliance light bulbs, air filters, water filters, other consumables, or knobs, handles, or other cosmetic parts.
11. Surcharges including, but not limited to, any after hour, weekend, or holiday service calls, tolls, ferry trip charges, or mileage expense for service calls to remote areas, including the state of Alaska.
12. Damages to the finish of appliance or home incurred during installation, including but not limited to floors, cabinets, walls, etc.
13. Damages caused by: services performed by unauthorized service companies; use of parts other than genuine Electrolux parts or parts obtained from persons other than authorized service companies; or external causes such as abuse, misuse, inadequate power supply, accidents, fires, or acts of God.

DISCLAIMER OF IMPLIED WARRANTIES; LIMITATION OF REMEDIES

CUSTOMER'S SOLE AND EXCLUSIVE REMEDY UNDER THIS LIMITED WARRANTY SHALL BE PRODUCT REPAIR OR REPLACEMENT AS PROVIDED HEREIN. CLAIMS BASED ON IMPLIED WARRANTIES, INCLUDING WARRANTIES OF MERCHANTABILITY OR FITNESS FOR A PARTICULAR PURPOSE, ARE LIMITED TO ONE YEAR OR THE SHORTEST PERIOD ALLOWED BY LAW, BUT NOT LESS THAN ONE YEAR. ELECTROLUX SHALL NOT BE LIABLE FOR CONSEQUENTIAL OR INCIDENTAL DAMAGES SUCH AS PROPERTY DAMAGE AND INCIDENTAL EXPENSES RESULTING FROM ANY BREACH OF THIS WRITTEN LIMITED WARRANTY OR ANY IMPLIED WARRANTY. SOME STATES AND PROVINCES DO NOT ALLOW THE EXCLUSION OR LIMITATION OF INCIDENTAL OR CONSEQUENTIAL DAMAGES, OR LIMITATIONS ON THE DURATION OF IMPLIED WARRANTIES, SO THESE LIMITATIONS OR EXCLUSIONS MAY NOT APPLY TO YOU. THIS WRITTEN WARRANTY GIVES YOU SPECIFIC LEGAL RIGHTS. YOU MAY ALSO HAVE OTHER RIGHTS THAT VARY FROM STATE TO STATE.

If You Need Service Keep your receipt, delivery slip, or some other appropriate payment record to establish the warranty period should service be required. If service is performed, it is in your best interest to obtain and keep all receipts. Service under this warranty must be obtained by contacting Electrolux at the addresses or phone numbers below.

This warranty only applies in the USA and Canada. In the USA, your appliance is warranted by Electrolux Major Appliances North America, a division of Electrolux Home Products, Inc. In Canada, your appliance is warranted by Electrolux Canada Corp. Electrolux authorizes no person to change or add to any obligations under this warranty. Obligations for service and parts under this warranty must be performed by Electrolux or an authorized service company. Product features or specifications as described or illustrated are subject to change without notice.

USA
1.800.944.9044
Electrolux Major Appliances
North America
10200 David Taylor Drive
Charlotte, NC 28262



Canada
1.800.265.8352
Electrolux Canada Corp.
5855 Terry Fox Way
Mississauga, Ontario, Canada
L5V 3E4