

**FISHER & PAYKEL**

**PROFESSIONAL RANGE**

---

**RDV3 30" & 36"**  
models

**USER GUIDE**  
**US CA**

**⚠ WARNING!**

**If the information in this manual is not followed exactly, a fire or explosion may result causing property damage, personal injury or death.**

**Do not store or use gasoline or other flammable vapors and liquids in the vicinity of this or any other appliance.**

**WHAT TO DO IF YOU SMELL GAS**

- **Do not try to light any appliance.**
- **Do not touch any electrical switch.**
- **Do not use any phone in your building.**
- **Immediately call your gas supplier from a neighbor's phone.**
- **Follow the gas supplier's instructions.**
- **If you cannot reach your gas supplier, call the fire department.**

**Installation and service must be performed by a qualified installer, service agency or the gas supplier.**

# CONTENTS

---

|                                 |    |
|---------------------------------|----|
| Introduction                    | 3  |
| Safety and warnings             | 4  |
| Before you begin                | 10 |
| First use                       | 11 |
| Using the oven light            | 18 |
| Using the kitchen timer         | 19 |
| Changing the time               | 21 |
| Locking the control panel       | 22 |
| Unlocking the control panel     | 23 |
| Cooking options                 | 24 |
| Delayed Cook                    | 25 |
| Auto Off                        | 26 |
| Food Probe                      | 27 |
| Guided cooking                  | 30 |
| Cooking guide                   | 32 |
| Cooking charts                  | 38 |
| Cooktop use                     | 44 |
| User preference settings        | 46 |
| Wifi connection and remote mode | 48 |
| Sabbath Mode                    | 50 |
| Care and cleaning               | 52 |
| Using Self Clean                | 61 |
| Troubleshooting                 | 64 |
| Alert codes                     | 68 |
| Warranty and service            | 69 |



## INTRODUCTION

---

We hope you're excited to start cooking with your new Fisher & Paykel professional range. It's loaded with our latest cooking technology to ensure you perfect results for every dish, with a number of features designed for your safety and convenience.

**COOK WITH CONFIDENCE** With its high resolution touchscreen, this oven offers intuitive guided cooking experiences - from tips on manual cooking to a fully automated journey through preset recipes - to deliver the best results for chefs at all skill levels.

**PYROLYTIC SELF-CLEAN** Pyrolytic self-clean breaks down food residue at a very high temperature, leaving a light ash that's easily removed with a damp cloth.

Register your product online. It'll help us give you the best service possible, and we'll also let you know when we have special offers or promotions running. Go to [fisherpaykel.com/register](https://fisherpaykel.com/register) now.

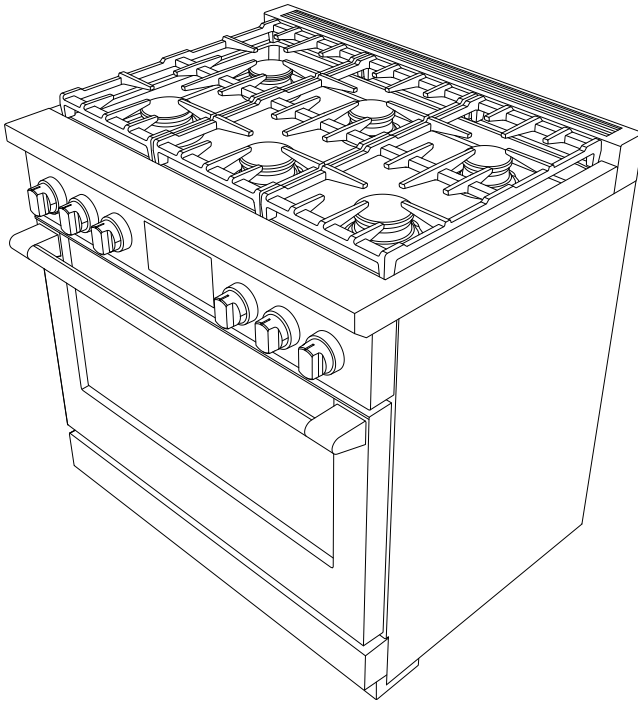

**⚠ WARNING!**



**Electric Shock Hazard**

**Failure to follow this advice may result in electric shock or death.**

- Turn the oven off at the wall before replacing the oven lamp.

**⚠ WARNING!**



**Fire Hazard**

**Failure to follow this advice may result in overheating, burning, and injury.**

- Carefully follow the instructions for starting a Self Clean cycle.
- Do not place combustible materials (for example: wood, fabric, plastic) in the oven during a self clean cycle.
- Do not place aluminium foil, dishes, trays, water or ice on the oven floor during cooking, this will irreversibly damage the enamel. Lining the oven with aluminium foil may cause fire.
- Never use your appliance for warming or heating the room. Persons could be burned or injured or a fire could start.
- Flammable materials should not be stored in an oven or near its surface.

**⚠ WARNING!**



**Cut Hazard**

**Failure to use caution could result in injury.**

- Take care: some edges are sharp.

### **⚠ WARNING!**



#### **Hot Surface Hazard**

**Failure to follow this advice could result in burns and scalds.**

- To avoid burns and scalds, keep children away from this appliance.
- Surfaces of the appliance may become hot enough to cause burns. Examples include the oven vent, the surface near the oven vent, and the oven door.
- Do not touch heating elements or interior surfaces of the oven. Heating elements may be hot, even when they are dark in colour.
- Use protection when handling hot surfaces, such as oven shelves or dishes.
- Be careful when opening the oven door. Let hot air or steam escape before removing or replacing food.
- During and after use, do not touch or let clothing or other flammable materials contact heating elements or interior surfaces of the oven until they have had sufficient time to cool.

### **⚠ WARNING!**



#### **Tipping Hazard**

**Failure to use caution could result in death or serious burns.**

- Range must be secured by a correctly installed anti-tip bracket. See installation guide for details.
- Ensure the anti-tip bracket is re-engaged when the range is moved. Do not use the appliance until it has been secured.

**⚠ WARNING!**



**Explosion Hazard**

**Failure to follow this advice may result in injury or death.**

- If you smell gas, do not use the appliance. Open a window or door to let the gas escape, then follow the guidance on the inside front cover of this manual.
- Do not use water on grease fires. A violent steam explosion may result.
- Turn all burners off, then smother fire or flame or use dry chemical or foam-type extinguisher.
- Do not heat unopened food containers such as cans - Build-up of pressure may cause container to burst

**⚠ WARNING!**



**Poisoning Hazard**

**Failure to follow this advice may result in carbon monoxide poisoning or overheating.**

- Never use material such as aluminium foil to cover an entire rack or the oven floor. Doing so block airflow through the oven.
- Clean the appliance with caution. Some cleaners can produce noxious fumes if applied to a hot surface. Follow the directions of the cleaner manufacturer.
- Never use this appliance as a space heater to heat or warm the room.



## SAFETY AND WARNINGS

---

### **WARNING!**

To reduce the risk of fire, electrical shock, injury to persons or damage when using the oven, follow the important safety instructions listed below. Read all the instructions before using the oven. Use the oven only for its intended purpose as described in these instructions.

#### **Installation**

- Ensure your appliance is properly installed and earthed by a qualified technician.
- Ensure this oven is connected to a circuit which incorporates an isolating switch providing full disconnection from the power supply.
- Do not install or operate the appliance if it is damaged or not working properly. If you receive a damaged product, contact your dealer or installer immediately.
- Verify the anti-tip device has been correctly installed and engaged. see installation guide for details.
- Ensure the anti-tip device is re-engaged when the range is moved.
- Do not operate the range without the anti-tip device engaged.

#### **Servicing**

- Do not repair or replace any part of the appliance unless specifically recommended in the user guide. All other servicing should be undertaken by a Fisher & Paykel trained and supported service technician or qualified person.

#### **Fire Hazard**

- Do not use water on grease fires. Smother the fire or flame or use a dry chemical or foam type extinguisher.
- Use only dry oven mitts or potholders. Moist or damp potholders on hot surfaces could result in burns from steam. Do not let potholders touch hot areas or heating elements. Do not use a towel or a bulky cloth for a potholder. It could catch fire.
- Do not heat unopened food containers. They can build up pressure that may cause the container to burst and result in injury.

#### **Food Safety**

- Leave food in the oven for as short a time as possible before and after cooking. This is to avoid contamination by organisms which may cause food poisoning. Take particular care during warm weather.

#### **General Use**

- Household appliances are not intended to be played with by children.
- Children should not be left alone or unattended in the area where the appliance is in use. They should never be allowed to sit or stand on any part of the appliance.
- Children of less than 8 years old must be kept away from the appliance unless continuously supervised.
- This appliance can be used by children aged from 8 years and above, and persons with reduced physical, sensory or mental capabilities or lack of experience and knowledge, if they have been given supervision or instruction concerning the use of the appliance in a safe way and they understand the hazards involved. Cleaning and user maintenance shall not be carried out by children without supervision.
- Caution: do not store items of interest to children in cabinets above the range or on the backguard of the range. Children climbing to reach items could be seriously injured.

## SAFETY AND WARNINGS

---

- Do not place heavy objects on the oven door.
- Always keep oven vents unobstructed.
- This appliance is configurable to allow remote operation at any time. Do not store flammable or temperature sensitive items inside, on top of, or near the appliance.
- Do not wear loose fitting or hanging garments when using the appliance. They could ignite or melt if they touch an element or hot surface and you could be burned.
- Do not change or modify the wireless communication device in any way. Changes or modifications not expressly approved by Fisher & Paykel could void the user's authority to operate the equipment.
- This device complies with Industry Canada's licence-exempt RSSs. Operation is subject to the following two conditions:
  - ① This device may not cause interference; and
  - ② This device must accept any interference, including interference that may cause undesired operation of the device.
- This device complies with part 15 of the FCC Rules. Operation is subject to the following two conditions:
  - ① This device may not cause harmful interference, and
  - ② this device must accept any interference received, including interference that may cause undesired operation.
- **Caution:** Hot air can blow from the vent at the top of the oven as part of the oven's cooling system.
- Always position shelves in the desired location while the oven is cool (before preheating). If a shelf must be removed while the oven is hot, do not let the oven mitts or pot-holder contact hot heating elements in the oven or the base of the oven.
- Use only bakeware approved for oven use. Follow the bakeware manufacturer's guides.
- Only certain types of glass, glass/ceramic, earthenware or other glazed utensils are suitable for range-top service without breaking due to sudden temperature changes.
- This appliance is equipped with one or more surface units of different size. Select utensils with flat bases large enough to cover the heating element. The use of undersized utensils will expose a portion of the heating element to direct contact and may result in ignition of clothing.
- Ensure flow of combustion and ventilation is unobstructed.
- Do not use the oven for storage.

### Cleaning and maintenance

- Do not clean the oven seal or use any oven-cleaning products on it. It is essential for a good seal, which ensures that the oven operates efficiently. Care should be taken not to rub, damage or move the oven seal.
- Do not use oven cleaners, harsh/abrasive cleaning agents, waxes, or polishes. No commercial oven cleaner, oven liner, or protective coating of any kind should be used in or around any part of the oven.
- Do not use harsh/abrasive cleaners, scourers or sharp metal scrapers to clean the oven door glass since they scratch the surface, which may result in the glass shattering.
- Clean only the parts listed in this manual.
- Do not use a steam cleaner to clean any part of the oven.
- Keep appliance area clear and free from combustible materials.

## SAFETY AND WARNINGS

---

### Self Cleaning

- Spillages must be removed before starting a Self Clean cycle.
- Before starting a Self Clean cycle, remove oven shelves and all other cookware/utensils, and wipe up large food spills or grease deposits.
- Before starting a Self Clean cycle, ensure you move any pet birds to another, closed and well ventilated room. Some pet birds are extremely sensitive to the fumes given off during Self Clean and may die if left in the same room as the oven during a cycle.
- During a Self Clean cycle, the oven reaches higher temperatures than it does for cooking. Under such conditions, the surfaces may get hotter than usual and children should be kept away.

## BEFORE YOU BEGIN

### IMPORTANT!

**Do not block the vents of the oven or the oven door with cookware, utensils or towels. During cleaning, take care not to let any liquids run down these vents.**

- Ensure that the anti-tip bracket at the right rear of the range has been correctly installed.
- Read this guide, taking special note of the 'Safety and warnings' section.
- Remove all packaging from the oven and cooktop. Recycle items that you can.
- Remove any adhesive residue using dishwashing liquid on a soft cloth — Do not use any harsh or abrasive cleaners.
- Condition the oven, using the instructions under 'First use'.

RDV3-366 model illustrated

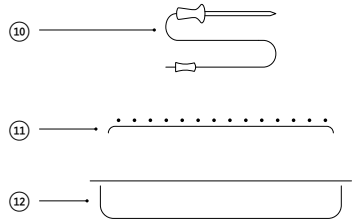
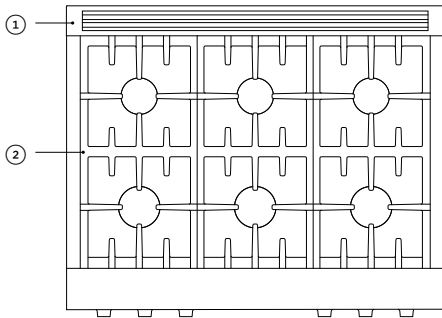

### Oven features and accessories

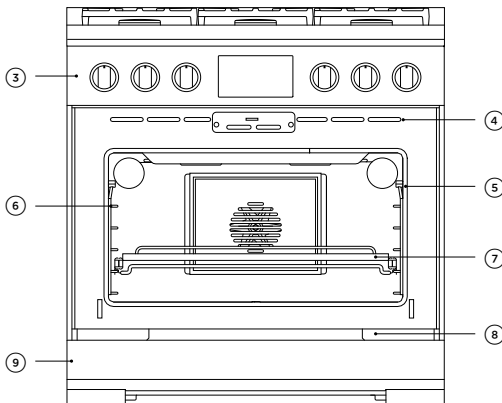

- ① Back trim
- ② Burner grates
- ③ Control panel
- ④ Oven vent louvres
- ⑤ Oven seal
- ⑥ Side rack
- ⑦ Full extension sliding shelf
- ⑧ Serial label
- ⑨ Toe kick
- ⑩ Food probe
- ⑪ Broil rack
- ⑫ Broil pan

# FIRST USE

## Replace shelving in your preferred positions

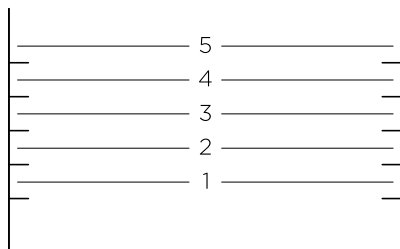

### Shelf positions

Always position the oven shelves before turning the oven on. Remove any unused shelves and baking utensils from the oven.

For advice on which shelf position to use, see sections 'Cooking charts'.

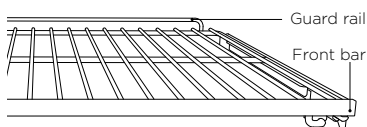

### Replacing the shelves

- ① Grip the shelf at the front (ensuring you are holding the wire shelf and the sliding frame together).
- ② Ensure the shelf is level and facing the right way with the guard rail at the back.
- ③ Place the shelf on top of the side racks at the desired height, hooking the rear tags over the side racks on both sides.
- ④ Push the shelf all the way into the oven, making sure the front tags are also securely hooked over the side racks.

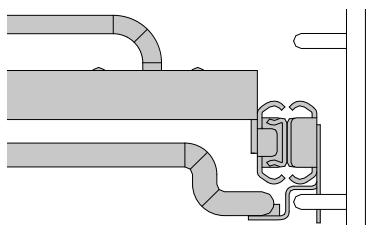

Ensure sliding shelves are positioned on top of the side rack wires instead of between them.

The wire shelves and slides are built together as one unit. When positioned correctly, the slides will prevent the wire shelves from tilting when pulled forward.

# FIRST USE

## Control panel

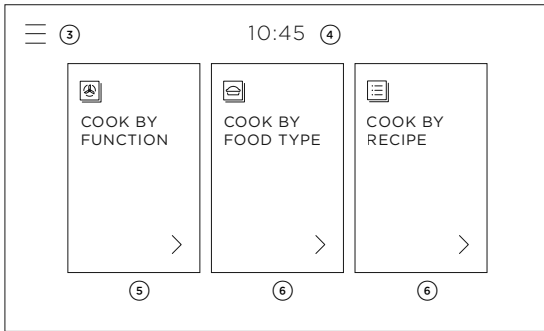
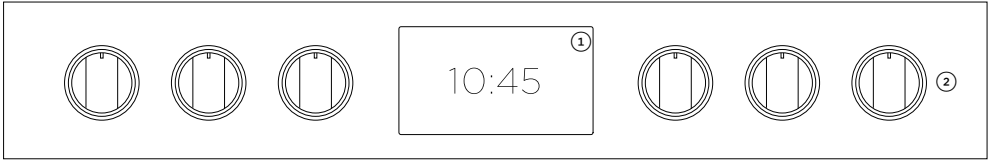

### Control panel features

- ① Touch screen display
- ② Burner dials
- ③ Menu
- ④ Clock
- ⑤ Oven functions
- ⑥ Guided cooking features

### Touch screen display

Your oven is operated using an intuitive touch screen display. Use the screen to navigate cooking functions, guided cooking features and settings.

### Using the touch controls

Use the ball of your finger, not its tip. The controls respond to touch, so pressure is not needed.

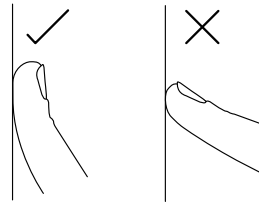

### Using the burner dials

To use the burner dials, push the dial in and turn counterclockwise to **LITE**. Hold the dial at **LITE** before turning to a flame setting.

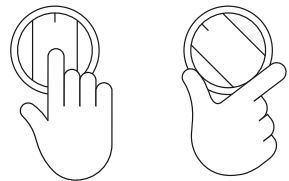

### Dial halos

When a dial is in use, a red halo will illuminate. This halo will change from red to white if the dial is turned to **OFF** but another dial remains active. If all dials are turned to **OFF**, all halos will dim.

# FIRST USE

## Setting the clock

You'll need to set the time on your oven when it is first turned on, or after a power cut.

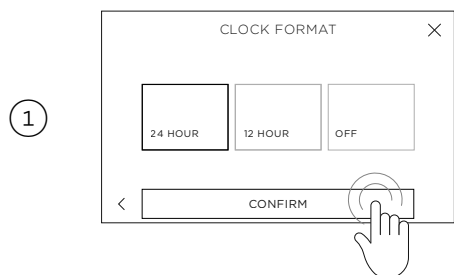

Set the clock format. Choose between **24 HOUR**, **12 HOUR** or **OFF** then select **CONFIRM**.

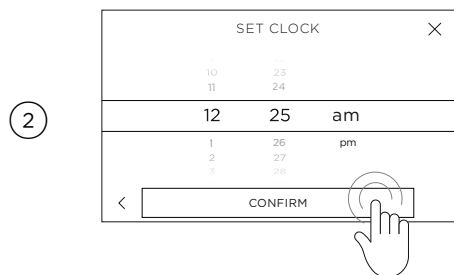

Scroll to set the correct time then select **CONFIRM**.

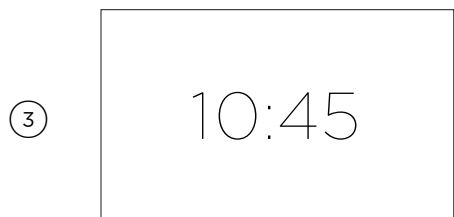

The time is now set and will show on the screen.

# FIRST USE

## Function menu layout

To select and use a function, touch the function name or icon. For more information on each function, touch the description underneath each function name.

### Select function

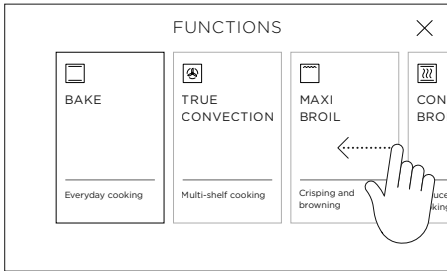

### Expand description

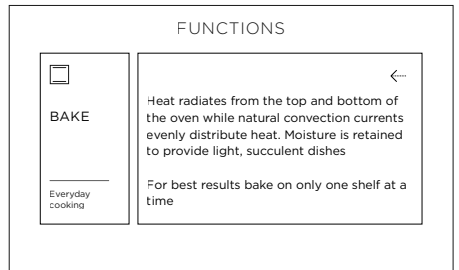
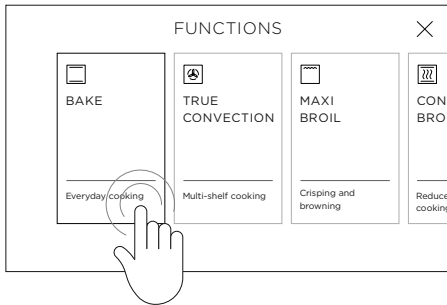



# FIRST USE

## Setting a function and temperature

For more information on the functions, touch the description underneath each function name or see the 'Cooking guide' section of this book.

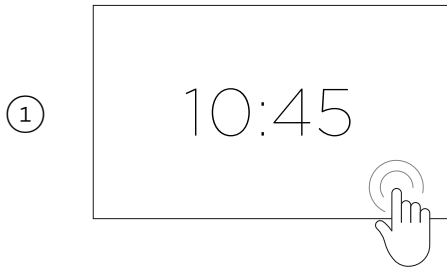

Touch the screen or turn the dial\* to enter the menu. Select **COOK BY FUNCTION**.

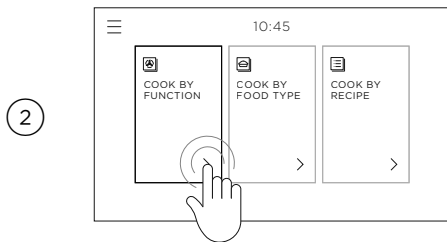

Scroll through the functions and select the one you want to cook with.

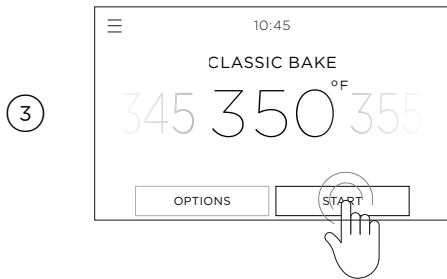

To adjust the preset temperature, swipe left or right. Touch **START** to heat the oven and begin cooking.

A red bar will show on the screen while the oven is heating.

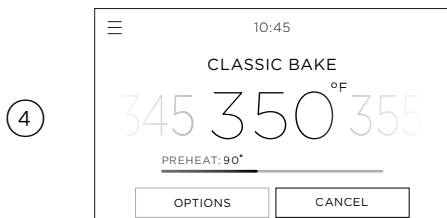

When the oven has reached the set temperature, a tone will sound and the bar will disappear.

Some functions do not need to preheat. For those functions the bar won't show.

# FIRST USE

## Editing or cancelling cooking

Touch the function name or temperature at any point during cooking to adjust.

### Changing the temperature

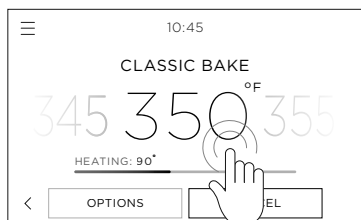

### Changing the function

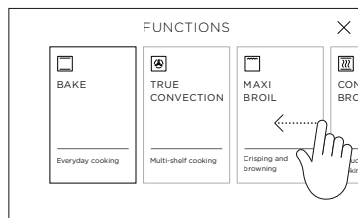
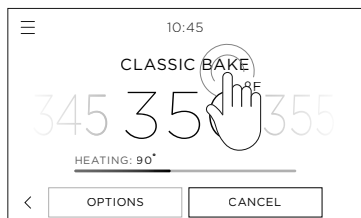

### Turning the oven off

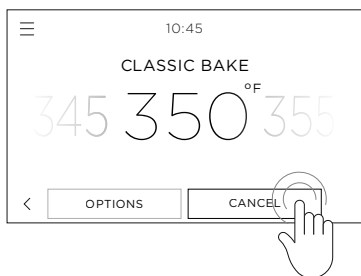

To stop cooking and turn the oven off, press **CANCEL** and then **CONFIRM** at any point.

# FIRST USE

## Conditioning the oven

It is important to condition your oven before using it for cooking. This will burn off any manufacturing residues and ensure that you get the best results right from the start. It will take approximately 1 hour.

### Before you start:

Make sure you have removed all packaging and any cable ties used to secure the shelving during transit. Make sure all shelves are fitted in the oven. Make sure the kitchen is well ventilated during conditioning.

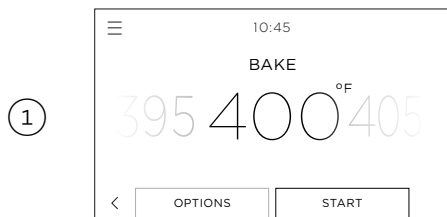

Select **COOK BY FUNCTION** and set the oven to **BAKE** at 400°F (200°C) and heat for 30 minutes.

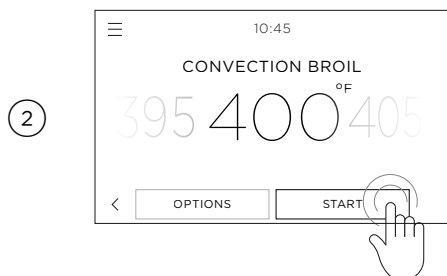

After 30 minutes change the function to **CONVECTION BROIL** and heat for 5 minutes.

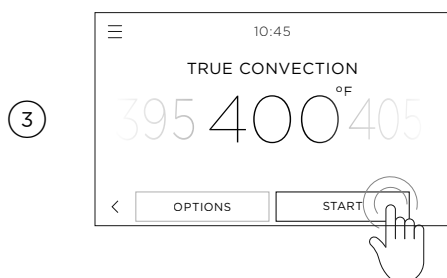

After 5 minutes, change the function to **TRUE CONVECTION** and heat for a further 20 minutes. When you have finished, turn the oven off.

### After conditioning:

There will be a distinctive smell and a small amount of smoke during the conditioning process as manufacturing residue is burnt off. This is normal, but make sure the kitchen is well ventilated. Once cooled, wipe out the oven with a damp cloth and mild detergent, and dry thoroughly.

## USING THE OVEN LIGHT

### Turning the oven light ON or OFF

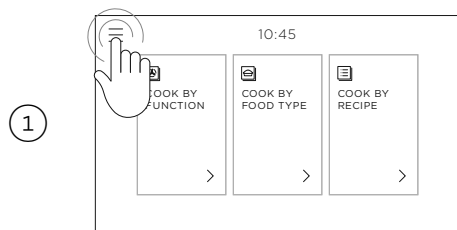

Touch the menu icon in the top left corner of the display.

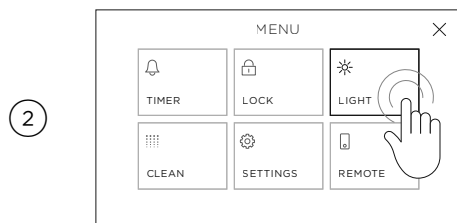

Select **LIGHT**.

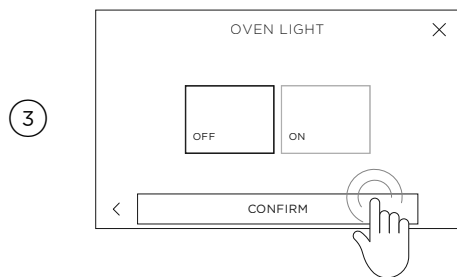

Select **ON** or **OFF** as required and then select **CONFIRM**.

## USING THE KITCHEN TIMER

- Use the kitchen timer to keep track of cooking times. You can use it at any time, even if you are not using the oven.
- The kitchen timer does not turn the oven off. See 'Cooking options' for how to set the **AUTO OFF** timer or **DELAYED COOK**.

### Setting the timer

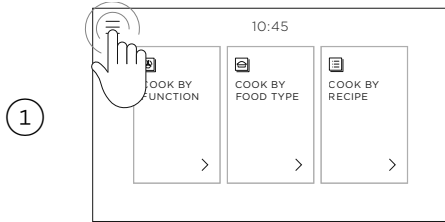

Touch the menu icon in the top left corner of the screen.

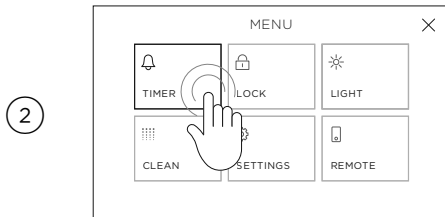

Select **TIMER**.

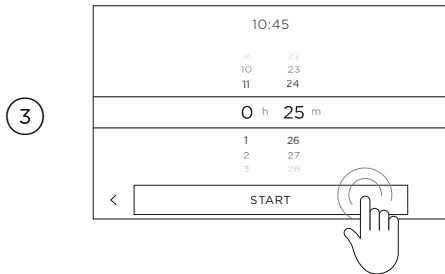

Scroll to set timer length then select **START**. You can set the timer for up to 11 hours 59 minutes.

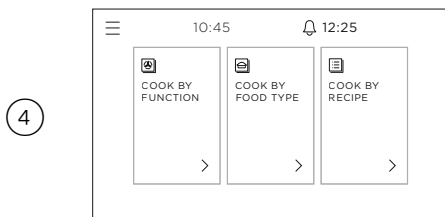

The timer countdown will show on the screen.

# USING THE KITCHEN TIMER

## Editing or cancelling the timer

1

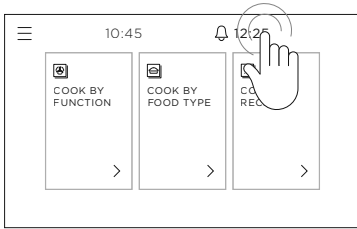

Touch the timer countdown in the upper right of the screen.

2

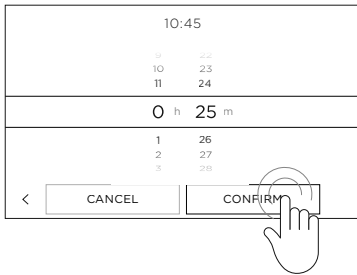

Adjust the timer as needed and select **CONFIRM**, or touch **CANCEL** to cancel the timer completely.

3

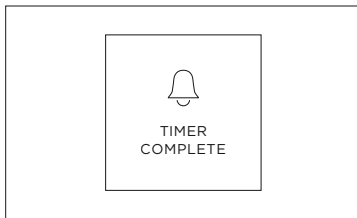

At the end of the timer a tone will sound every few seconds. Touch the screen anywhere to stop it.

## CHANGING THE TIME

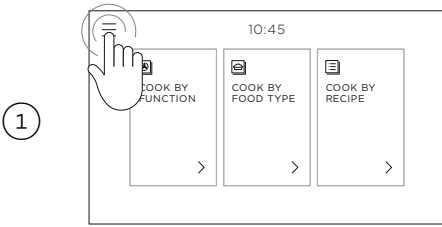

Touch the menu icon in the top left corner.

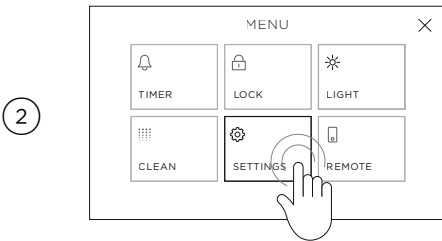

Select **SETTINGS**.

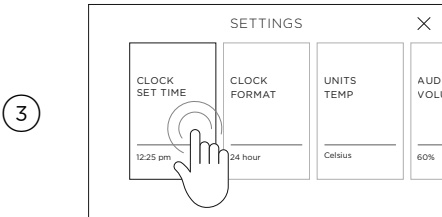

Select **CLOCK SET TIME**.

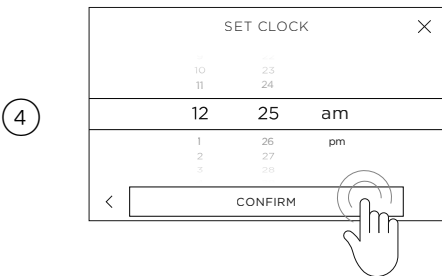

Scroll to change the time then select **CONFIRM**.

## LOCKING THE CONTROL PANEL

Lock the oven controls to prevent accidental use of the oven by children or when cleaning. When locked, the controls are unresponsive and the oven will not turn on.

For safety reasons you cannot lock the oven controls while the oven is in use or if automatic cooking options have been set.

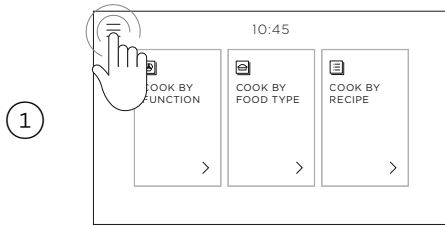

Touch the menu icon in the top left corner of the screen.

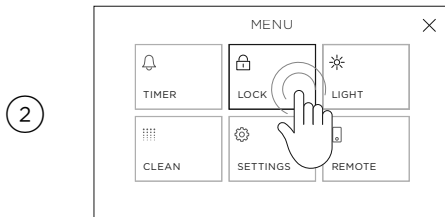

Select **LOCK**.

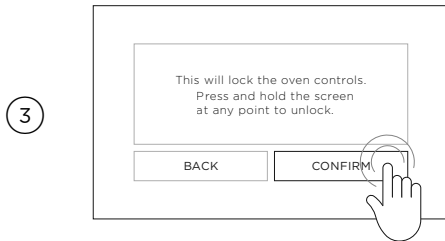

Select **CONFIRM**.

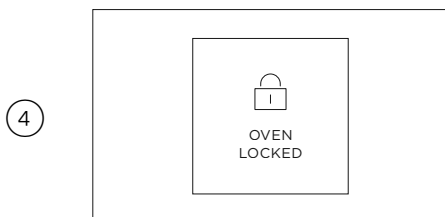

The control panel is now locked. The controls will remain unresponsive until it is unlocked.



## UNLOCKING THE CONTROL PANEL

---

1

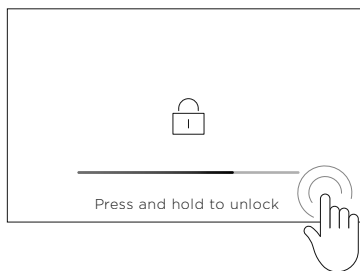

Press and hold anywhere on the screen until the bar fills and the oven unlocks.

# COOKING OPTIONS

Your oven comes with a number of automatic cooking options to help you get the best results:



## DELAYED COOK

Set the oven to turn on later in the day, cook for a set length of time and turn off automatically.



## AUTO OFF

Set the oven to turn off after a set length of time.



## FOOD PROBE

Use the food probe to automatically turn your oven off when your food reaches a set internal temperature.

You can set these options either before you start cooking, or at any point once your oven is already running.

1

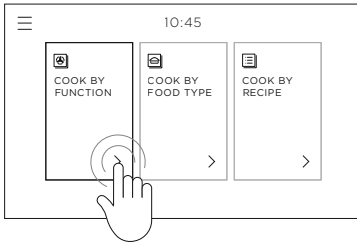

Select **COOK BY FUNCTION**.

2

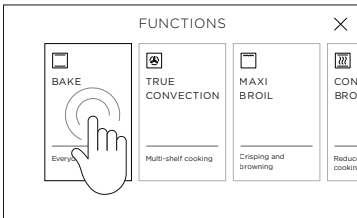

Select the function you want to cook with.

3

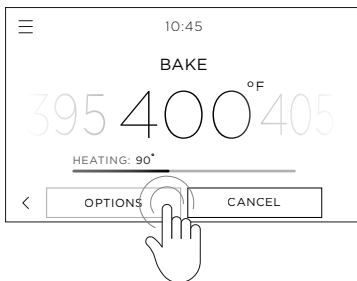

Touch **OPTIONS** at the bottom of the screen and select the option you want to use.

## DELAYED COOK

The broil element may come on while the oven is heating up. Position food on a lower shelf or cover to prevent burning as the oven heats up.

Safe food handling: leave food in the oven for as short a time as possible before and after cooking or defrosting, to avoid contamination by organisms which may cause food poisoning. Take particular care during warmer weather.

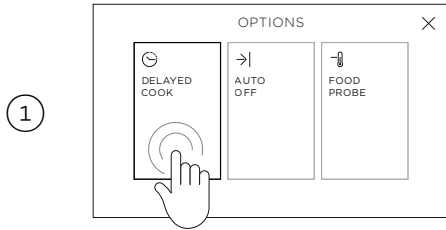

Select **DELAYED COOK** from the **OPTIONS** menu.

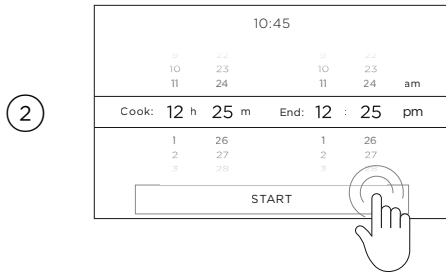

Scroll to set a cook time and an end time, then select **START**.



**DELAYED COOK** is now set.

Your oven will automatically calculate when it needs to turn on based on what cook time and end times are set.

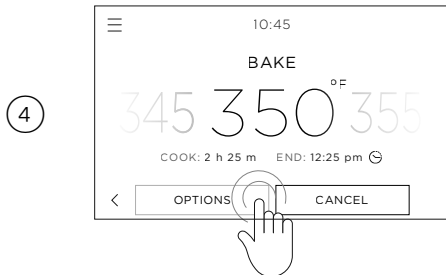

**To edit or cancel**

Touch **OPTIONS** and select **DELAYED COOK** at any point to edit or cancel.

**When the end time is reached**

The oven will automatically turn off and a long tone will sound.

## AUTO OFF

1

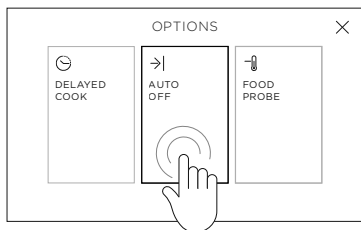

Select **AUTO OFF** from the **OPTIONS** menu.

2

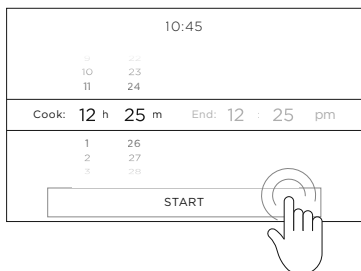

Scroll to set a cook time and select **START**.

Your oven will automatically calculate the end time based on what cook time is set.

3

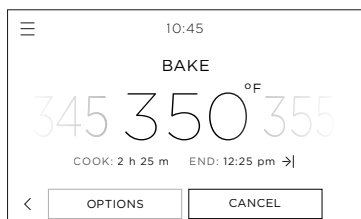

**AUTO OFF** is now set.

Your oven will cook for the set length of time and then turn off automatically.

4



### To edit or cancel

Touch **OPTIONS** and select **AUTO OFF** at any point to edit or cancel.

### When the end time is reached

The oven will automatically turn off and a long tone will sound.

## FOOD PROBE

---

### Tips for using the food probe

- You can still use the kitchen timer when the probe is in use.
- You cannot use the meat probe with **DELAYED COOK** or **AUTO OFF**.
- The internal temperature of meat will continue to rise by a few degrees after you have removed it from the oven, so allow for this in your calculations. After cooking, cover and let the meat rest for 15 to 20 minutes.
- If you wish to remove food from the oven (eg basting), unplug the meat probe from the oven but do not remove it from the meat. When you are ready to resume cooking, ensure you plug the probe plug back into the oven.
- When cooking meat, insert the probe horizontally into the centre of the thickest part. The thicker the meat, the longer it will take to cook, so it is important that the tip of the probe is measuring the temperature of the meat at its thickest point. Make sure the tip of the probe is not protruding out of the meat, and does not touch bone, fat or gristle, as these will heat up more quickly than the lean meat.

### Internal temperatures and food safety

- Ensure meat is fully defrosted before cooking. The temperatures given onscreen and in the Cooking Guides are recommendations. Results will depend on the quality and composition of the food.
- Rest meat after cooking to allow the internal temperature to continue to rise.
- For food safety, high risk foods such as fish should reach a minimum internal temperature of 145 - 160°F (63 - 70°C) and poultry and minced meat should reach 165 - 185°F (75 - 85°C).

# FOOD PROBE

## Setting FOOD PROBE

1

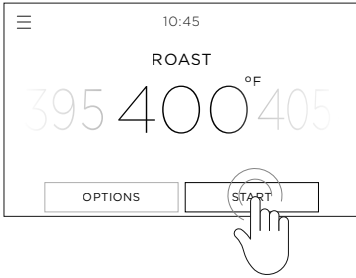

Select your function and temperature and preheat the oven if needed.

2

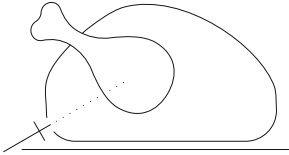

Insert the probe into your food.  
Always position the tip of the probe in the thickest part of the dish, avoiding fat and bone in meat.  
Ensure the tip of the probe doesn't protrude out the other side of food or touch cookware.

3

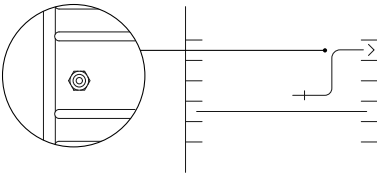

Place food in the oven and plug the probe into the socket inside the oven, on the right hand side.

4

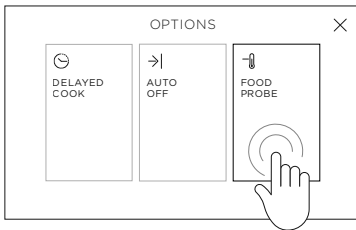

Go to the **OPTIONS** menu and select **FOOD PROBE**.

# FOOD PROBE

5

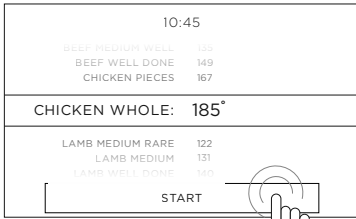

Scroll to select a food type and adjust the temperature if desired. Select **START** to begin.

6

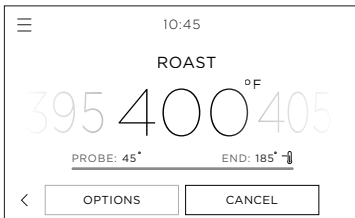

**FOOD PROBE** is now set.

Your oven will cook until the set temperature is reached and then turn off automatically.

7

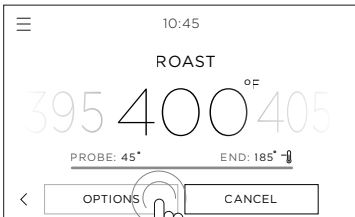

**To edit or cancel**

Touch **OPTIONS** and select **FOOD PROBE** at any point to edit or cancel.

**When the end time is reached**

The oven will automatically turn off and a tone will sound.

## GUIDED COOKING

Your oven comes with guided cooking features that help you choose the optimal oven settings, accessories and methods to get the best results:



### COOK BY FOOD TYPE

Optimum oven settings, shelf positions, cookware and accessories for cooking a particular type of food or cut of meat.



### COOK BY RECIPE

A collection of recipes that have been specifically designed for and tested in this style of oven.

### Using COOK BY FOOD TYPE

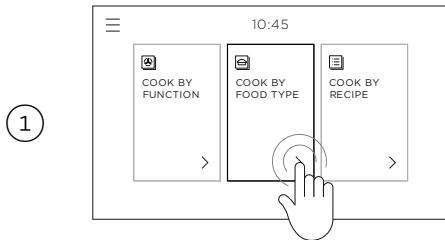

From the home screen, select **COOK BY FOOD TYPE**.

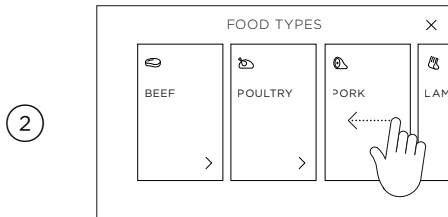

Scroll through the various food types and select the type of food you want to cook.

For more information touch the description underneath each food type.

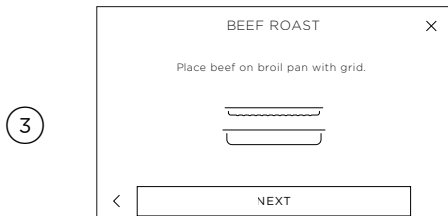

Follow the instructions onscreen for what accessories and cookware to use and how to set up your oven.



# GUIDED COOKING

## Using COOK BY RECIPE

1

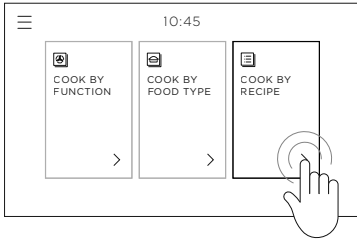

Select COOK BY RECIPE.

2

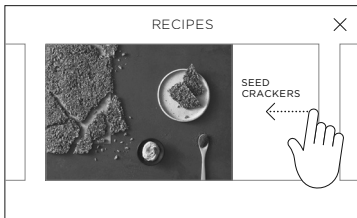

Scroll to look through the recipe collection and select your favourite.

Follow the instructions onscreen for ingredients and method, and how to set up your oven.

# COOKING GUIDE

## General guidelines

This range has been designed to utilise its four elements and rear fan in different combinations to provide you with enhanced performance. The wide range of functions, allows you to cook all food types to perfection.

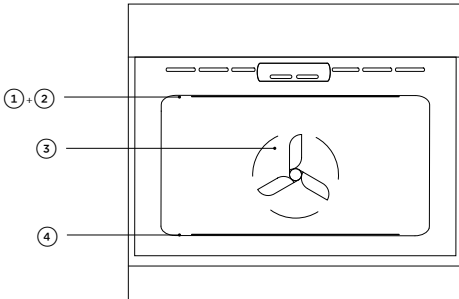

## Oven elements

- ① upper outer element
- ② upper inner element
- ③ rear element (concealed)
- ④ lower element (concealed)

## IMPORTANT!

Use all the functions with the oven door closed.

### Baking

- For best results when baking, always pre-heat your oven. The screen will show a red progress bar while the oven is heating up.
- **Single shelf cooking:** place your baking on a shelf that will position the top of your pan near the centre of the oven.
- **Multi shelf cooking:** Always leave a space between shelves to allow the air to circulate.

### Broiling

- Always broil with the oven door completely shut.
- Always keep a close watch on your food to avoid charring or burning.
- If you use glass or ceramic pans, be sure they can withstand high oven temperatures.
- For thinner cuts of meat, or for toasting or browning foods, use a higher shelf position.
- Thicker cuts of meats should be broiled on lower shelves or at a lower broil setting to ensure even cooking.

### Roasting

- The **ROAST** function is designed to brown the outside of the meat, but still keep the inside moist and juicy.
- Boneless, rolled or stuffed roasts require longer than roasts containing bones. Poultry should be well cooked with the juices running clear and a minimum internal temperature of 165°F (75°C).
- Always roast meat fat side up.
- If using a roasting bag or a covered roast dish, do not use the **ROAST** function.

## COOKING GUIDE

---

### Reheating

- **Never reheat food more than once.**
- Use Bake to reheat food, or follow the instructions in **COOK BY FOOD TYPE**.
- Always reheat food to piping hot, or to a minimum internal temperature of 185°F (85°C). This reduces the risk of contamination.
- Reheat food in a dish with a lid or cover tightly with foil.
- Once hot, use the **WARM** function to keep the food warm.

### Dehydrating

- Use the **DEHYDRATE** function to preserve food and create healthy snacks.
- For best results, use the broil pan with broil rack insert. Ensure food is laid flat and is not overlapping. If dehydrating meat, turn it over halfway through to ensure even drying.
- Store dehydrated food in an airtight container after it's completely cooled.

### Dough proofing

- Use the **RAPID PROOF** function to proof dough for breadmaking and pizza.
- Place dough in a lightly oiled bowl and cover with plastic wrap or a clean, damp cloth.
- Position in the centre of the oven.
- To prevent overproofing check the dough every 30 minutes.

## COOKING GUIDE

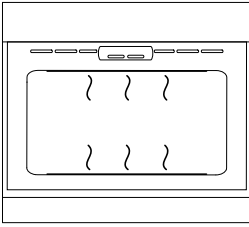

### BAKE

upper outer and lower elements

#### Ideal for:

- foods that require a longer cooking time, eg rich fruit cake, brownies, or bread.
- Retains moisture
- Ideal for cakes and foods that require baking for a long time or at low temperatures.
- This function is not suitable for multi-shelf cooking.

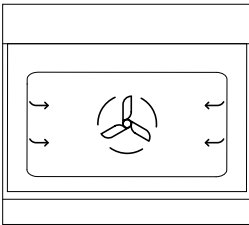

### TRUE CONVECTION fan plus rear element

#### Ideal for:

multi-shelf cooking, eg biscuits, cookies, scones, muffins and cupcakes.

- Hot air is blown into the cavity, providing a consistent temperature at all levels
- Always leave a gap between trays to allow air to move freely. This ensures food on the lower tray can still brown.
- If converting a recipe from **BAKE** to **TRUE CONVECTION**, we recommend that you decrease either the bake time and/or the temperature by approximately 70°F (20°C), especially for items with longer bake times.

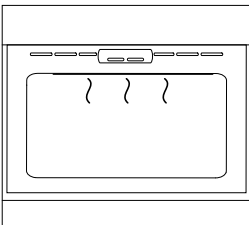

### MAXI BROIL

upper inner and outer elements

#### Ideal for:

toasting bread or for top-browning to finish off dishes.

- Intense radiant heat is delivered from both top elements.
- There are 9 steps between **LO** and **HI** (100% power).
- For best results allow oven to heat for 5 minutes before broiling.
- The dial halo\* will remain red while using the broil function.

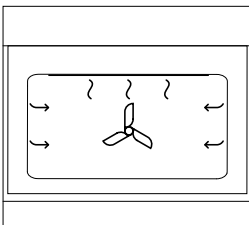

### CONVECTION BROIL

fan plus upper outer and inner elements

#### Ideal for:

whole chicken, beef tenderloin or broiling fish or steak.

- Uses the intense heat from the elements for top-browning and the fan to ensure even cooking of foods.
- Meat, poultry and vegetables cook beautifully; food is crisp and brown on the outside while the inside remains moist.

## COOKING GUIDE

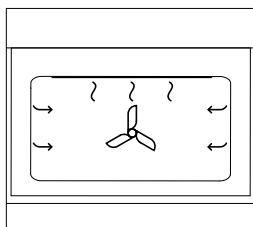

### **ROAST** fan plus upper and lower elements

#### **Ideal for:**

roasting meat and vegetables.

#### **This is a two-step program.**

- **Searing:**

An initial 20-minute stage that crisps and browns the roast, and caramelises the outside of the meat.

- **Cooking at preset temperature:**

After searing, the temperature will decrease to your preset level for the remainder of the cook time, producing a tender and juicy roast.

- The oven does not need preheating.
- If desired, use the broil pan and grid, or place vegetables under the roast to allow the juices to drain away from your meat. This will allow the hot air to circulate under the meat as well.

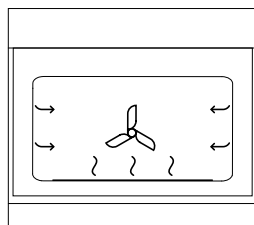
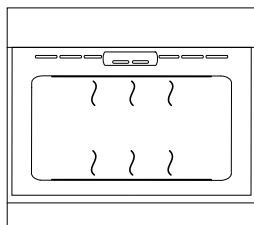

### **PIZZA BAKE** fan plus lower element

#### **Ideal for:**

crisp-based pizzas

- The fan circulates heat from the lower element throughout the entire oven.
- Excellent for cooking pizza as it crisps the base beautifully without overcooking the topping.
- For best results, pre-heat a pizza stone for at least 1 hour and bake on oven shelf position 1 or 2.

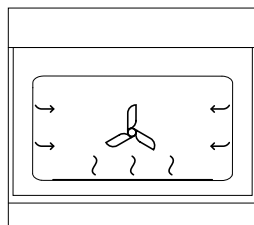

### **PASTRY BAKE** fan plus lower element

#### **Ideal for:**

sweet and savoury pastry foods and delicate foods that require a crisp base and some top-browning, eg frittata, quiche.

- The fan circulates heat from the lower element throughout the oven.
- Provides intense heat to the base of foods and allows gentle top-browning.

## COOKING GUIDE

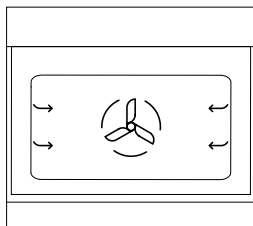

### **SLOW COOK** fan plus rear element

#### **Ideal for:**

slow-cooked dishes such as casseroles, stews and braises.

- The fan circulates heat from the rear element to gently cook food.
- This function has low energy consumption — oven lights will remain off and vents will remain closed for the duration of cooking to conserve energy (you may observe some moisture generation during this time).
- The oven does not need preheating.

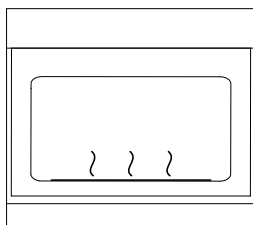

### **CLASSIC BAKE** lower element

#### **Ideal for:**

dishes that require delicate baking and have a pastry base, like custard tarts, pies, quiches and cheesecake.

- Heat comes from the lower element only.
- This is the traditional baking function, suitable for recipes that were developed in conventional ovens
- Bake using only one shelf at a time.

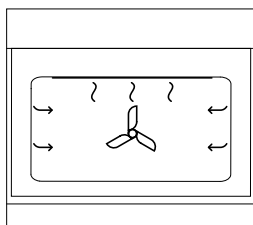

### **AIR FRY** fan plus outer and inner elements

#### **Ideal for:**

food cooked from frozen, or battered and crumbed food that would usually be deep fried.

- Replicates the conditions used in an air fryer.
- A healthier way of frying which crisps food while using less oil. For best results, coat food with 1-2 tablespoons of oil.
- For pre-packaged food: if the manufacturer's cooking advice suggests using a function that isn't fan-based, decrease temperature by 70°F (20 °C)
- **Single shelf cooking:** cook in the upper part of the oven, but not at the highest shelf position.

## COOKING GUIDE

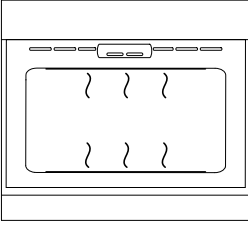

### RAPID PROOF

upper outer and lower elements

- Gentle heat is generated from the upper and lower elements
- Provides the optimum warm and draft-free environment for proving yeast dough.
- This method provides a faster proof time than at room temperature.

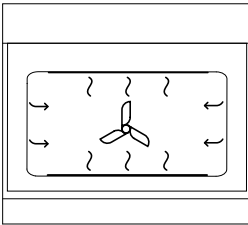

### DEHYDRATE

fan plus rear element

#### Ideal for:

Ideal for drying meat, fruit, vegetables and herbs, such as beef jerky and fruit leather.

- Gently circulates air, providing a consistent low heat for dehydrating and drying food.

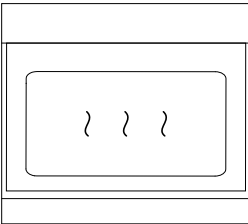

### WARM

upper outer and lower elements plus venting

- Provides a constant low heat of less than 195°F (90°C).
- Use to keep cooked food hot, or to warm plates and serving dishes.
- To reheat food from cold, use another function or **COOK BY FOOD TYPE** to heat the food piping hot, then change to **WARM**, as this function alone will not bring cold food up to a high enough temperature to kill any harmful bacteria.

## COOKING CHARTS

### Shelf positions

- Position shelves before you turn the oven on.
- Shelf positions are counted from the base up, with 1 being the lowest shelf position and 5 the highest.

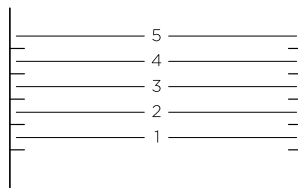

### During cooking

- Preheat the oven to the required temperature.
- The broil element may come on while the oven is heating up.
- The screen will show a red temperature bar while the oven is heating up.
- Oven accessories may temporarily deform slightly when they become hot. This is normal and does not affect their function.

The information in these charts is for guidance only. Refer to your recipe or the packaging and be prepared to adjust the cooking times and settings accordingly.

| BAKING                | SHELVES | FUNCTION        | SHELF POSITION | TEMP (°F) | TEMP (°C) | TIME (MIN) |
|-----------------------|---------|-----------------|----------------|-----------|-----------|------------|
| <b>BISCUITS</b>       |         |                 |                |           |           |            |
| Plain                 | Single  | Bake Convection | 3              | 400-425   | 210-220   | 8-10       |
|                       | Multi   | True Convection | 1 and 3        | 425-450   | 215-230   | 10-12      |
| Chewy choc chip       | Single  | Bake Convection | 3              | 355-375   | 180-190   | 10-15      |
|                       | Multi   | True Convection | 1 and 3        | 325-340   | 160-170   | 10-15      |
| Sugar cookies         | Single  | Bake Convection | 3              | 350-375   | 175-190   | 7-15       |
|                       | Multi   | True Convection | 1 and 3        | 325-350   | 160-175   | 7-15       |
| <b>CAKES</b>          |         |                 |                |           |           |            |
| Pound cake            | Single  | Bake            | 3              | 325       | 160       | 70-80      |
| Angel food cake       | Single  | Bake            | 3              | 325-350   | 160-175   | 50-60      |
| Rich fruit            | Single  | Bake            | 3              | 275-300   | 135-150   | 3-6 hrs    |
| Sponge (single large) | Single  | Bake            | 3              | 350       | 175       | 30-40      |
| Sponge (2 small pans) | Single  | Bake            | 3              | 350       | 175       | 15-25      |
| Brownie               | Single  | Bake            | 3              | 350       | 175       | 20-25      |
| <b>MERINGUES</b>      | Single  | Bake            | 3              | 250-270   | 120-130   | 60-70      |
| <b>SCONES</b>         | Multi   | Bake            | 3              | 425-450   | 215-230   | 10-12      |



## COOKING CHARTS

| BAKING  | SHELVES | FUNCTION        | SHELF POSITION | TEMP (°F) | TEMP (°C) | TIME (MIN) |
|---|---------|-----------------|----------------|-----------|-----------|------------|
| <b>MUFFINS/CUPCAKES</b>                         |         |                 |                |           |           |            |
| Muffins   | Single  | Bake Convection | 3              | 345       | 170       | 23-30      |
|   | Multi   | True Convection | 1 and 3        | 345       | 170       | 23-30      |
| Cupcakes  | Single  | Bake Convection | 3              | 365       | 185       | 13-18      |
|   | Multi   | True Convection | 1 and 3        | 345       | 170       | 13-18      |
| <b>BREAD</b>                                    |         |                 |                |           |           |            |
| Soft dinner rolls                               | Single  | Bake            | 2              | 375       | 190       | 15-18      |
| Wholewheat loaf                                 | Single  | Bake            | 2              | 375       | 190       | 35-45      |
| Sandwich loaf                                   | Multi   | Bake            | 2              | 350       | 175       | 40-50      |
| Dough proof                                     | Single  | Proof           | 2              | LO        | LO        | 30         |
| <b>PASTRY</b> (blind baked)                     | Single  | Pastry Bake     | 1              | 350       | 175       | 15         |
| <b>PIES</b>                                     |         |                 |                |           |           |            |
| Fruit pie (double crust)                        | Single  | Pastry Bake     | 1              | 350-400   | 175-200   | 20-25      |
| Baked cheesecake (in waterbath)                 | Single  | Classic Bake    | 1              | 325       | 160       | 50-60      |
| Pumpkin pie (blind baked, then filled)          | Single  | Pastry Bake     | 1              | 350-375   | 175-190   | 15-30      |
| English custard tart (blind baked, then filled) | Single  | Classic Bake    | 1              | 300-350   | 150-175   | 15-30      |
| <b>DESSERTS</b>                                 |         |                 |                |           |           |            |
| Crème brulee (in waterbath)                     | Single  | Classic Bake    | 1              | 275       | 135       | 35-45      |
| Crème Caramel (in waterbath)                    | Single  | Classic Bake    | 1              | 350       | 175       | 35-45      |

## COOKING CHARTS

| <b>BROILING</b>          | <b>SHELVES</b> | <b>FUNCTION</b>  | <b>SHELF POSITION</b> | <b>TEMP (°F)</b> | <b>TEMP (°C)</b> | <b>TIME (MIN)</b> |
|--------------------------|----------------|------------------|-----------------------|------------------|------------------|-------------------|
| <b>BEEF</b>              |                |                  |                       |                  |                  |                   |
| Steak, rare              | Single         | Convection Broil | 3*                    | 450-480          | 230-250          | 8-10              |
| Steak, medium            | Single         | Convection Broil | 3*                    | 450-480          | 230-250          | 10-15             |
| Burgers (ground patties) | Single         | Broil            | 3                     | HI               | HI               | 12-15             |
| Meatballs (ground)       | Single         | Broil            | 3                     | HI               | HI               | 12-15             |
| <b>LAMB</b>              |                |                  |                       |                  |                  |                   |
| Chops, medium            | Single         | Convection Broil | 3*                    | 425-480          | 220-250          | 15-20             |
| Chops, well done         | Single         | Convection Broil | 3*                    | 425-480          | 220-250          | 20-25             |
| <b>CHICKEN</b>           |                |                  |                       |                  |                  |                   |
| Bone-in pieces           | Single         | Convection Broil | 3                     | 350              | 175              | 40-50             |
| Boneless pieces          | Single         | Convection Broil | 3                     | 350              | 175              | 30-40             |
| <b>PORK</b>              |                |                  |                       |                  |                  |                   |
| Chops, well done         | Single         | Convection Broil | 3                     | 425-480          | 220-250          | 15-20             |
| Ham steak                | Single         | Broil            | 3                     | HI               | HI               | 15-20             |
| Bacon                    | Single         | Broil            | 3                     | HI               | HI               | 4-7               |
| <b>SAUSAGES</b>          | Single         | Broil            | 3                     | HI               | HI               | 10-15             |
| <b>FISH</b>              |                |                  |                       |                  |                  |                   |
| Filletts                 | Single         | Convection Broil | 3                     | 390-430          | 200-220          | 8-12              |
| Whole                    | Single         | Convection Broil | 3                     | 390-430          | 200-220          | 15-20             |
| <b>VEGETABLES</b>        |                |                  |                       |                  |                  |                   |
| Sliced                   | Single         | Convection Broil | 3                     | HI               | HI               | 8-12              |
| <b>SAVOURY</b>           |                |                  |                       |                  |                  |                   |
| <b>CORNBREAD</b>         | Single         | Bake Convection  | 2                     | 400-425          | 210-215          | 20-25             |
| <b>VEGETABLES</b>        | Single         | Bake Convection  | 2                     | 350-375          | 175-190          | 30-50             |
| <b>LASAGNE</b>           | Single         | Bake Convection  | 2                     | 350-375          | 175-190          | 35-40             |

## COOKING CHARTS

| SAVOURY         | SHELVES | FUNCTION        | SHELF POSITION | TEMP (°F) | TEMP (°C) | TIME (MIN) |
|-----------------|---------|-----------------|----------------|-----------|-----------|------------|
| QUICHE          | Single  | Pastry Bake     | 1              | 350       | 175       | 15-30      |
| PIZZA           | Single  | Pizza Bake      | 1              | 480       | 250       | 10-15      |
| CASSEROLES      | Single  | Slow Cook       | 1              | 300-350   | 150-175   | 1-4 hrs    |
| <b>POTATOES</b> |         |                 |                |           |           |            |
| Whole baked     | Single  | Bake            | 3              | 390       | 200       | 50-60      |
| <b>FRITTATA</b> |         |                 |                |           |           |            |
| Broil to finish | Single  | Bake Convection | 3              | 340-360   | 170-180   | 15-20      |
| OVEN MEALS      | Single  | True Convection | 3              | 340-375   | 170-190   | 30-40      |

| ROASTING                                      | SHELVES* | FUNCTION         | SHELF POSITION | TEMP (°F) | TEMP (°C) | TIME** (MIN) |
|---|----------|------------------|----------------|-----------|-----------|--------------|
| <b>BEEF, BONELESS</b> (times per 1lb/450g)    |          |                  |                |           |           |              |
| Rare  | Single*  | Roast/Bake       | 2              | 320-340   | 160-170   | 18-32        |
| Medium  | Single*  | Roast/Bake       | 2              | 320-340   | 160-170   | 25-40        |
| Well done                                     | Single*  | Roast/Bake       | 2              | 320-340   | 160-170   | 30-55        |
| <b>PRIME RIB ROAST</b> (times per 1lb/450g)   |          |                  |                |           |           |              |
| Rare  | Single*  | Roast/Bake       | 2              | 320-340   | 160-170   | 15-30        |
| Medium  | Single*  | Roast/Bake       | 2              | 320-340   | 160-170   | 20-35        |
| Well done                                     | Single*  | Roast/Bake       | 2              | 320-340   | 160-170   | 25-40        |
| <b>LAMB RACK</b>                              |          |                  |                |           |           |              |
| Medium Rare                                   | Single   | Broil Convection | 2              | 390       | 200       | 20           |
| <b>LAMB LEG, BONE IN</b> (times per 1lb/450g) |          |                  |                |           |           |              |
| Medium  | Single*  | Roast/Bake       | 2              | 320-340   | 160-170   | 18-28        |
| Well done                                     | Single*  | Roast/Bake       | 2              | 320-340   | 160-170   | 20-33        |
| <b>LAMB LEG, BONLESS</b> (times per 1lb/450g) |          |                  |                |           |           |              |
| Medium  | Single*  | Roast/Bake       | 2              | 320-340   | 160-170   | 20-35        |
| Well done                                     | Single*  | Roast/Bake       | 2              | 320-340   | 160-170   | 25-45        |

## COOKING CHARTS

| <b>ROASTING</b>   | <b>SHELVES*</b> | <b>FUNCTION</b>  | <b>SHELF POSITION</b> | <b>TEMP (°F)</b> | <b>TEMP (°C)</b> | <b>TIME** (MIN)</b> |
|---|-----------------|------------------|-----------------------|------------------|------------------|---------------------|
| <b>CHICKEN (WHOLE)</b> (times per 1lb/450g)                 |                 |                  |                       |                  |                  |                     |
| With stuffing   | Single*         | Roast/Bake       | 2                     | 350              | 175              | 17-22               |
| Without stuffing  | Single*         | Roast/Bake       | 2                     | 350              | 175              | 15-20               |
| Butterflied   | Single*         | Roast/Bake       | 2                     | 350              | 175              | 40-50               |
| <b>TURKEY, WHOLE</b> (times per 1lb/450g)                   |                 |                  |                       |                  |                  |                     |
| With stuffing   | Single*         | Bake             | 1 or 2                | 330-400          | 160-170          | 17-22               |
| Without stuffing  | Single*         | Bake             | 1 or 2                | 300-330          | 150-165          | 15-20               |
| <b>PORK CRACKLING</b>                                       |                 |                  |                       |                  |                  |                     |
| Crisp   | Single*         | Broil Convection | 3 or 4                | 430              | 220              | 5-10                |
| <b>VEAL</b> (times per 1lb/450g)                            |                 |                  |                       |                  |                  |                     |
| Medium  | Single*         | Roast/Bake       | 2                     | 320-340          | 160-170          | 20-40               |
| Well done   | Single*         | Roast/Bake       | 2                     | 320-340          | 160-170          | 25-45               |
| <b>PORK, BONELESS</b> (times per 1lb/450g)                  |                 |                  |                       |                  |                  |                     |
| Medium  | Single*         | Roast/Bake       | 2                     | 340-350          | 170-175          | 25-40               |
| Well done   | Single*         | Roast/Bake       | 2                     | 340-350          | 170-175          | 30-45               |
| <b>VENISON</b> (times per 1"/2.5cm thickness <sup>2</sup> ) |                 |                  |                       |                  |                  |                     |
| Rare  | Single*         | Broil Convection | 3                     | 435              | 225              | 7                   |
| Medium  | Single*         | Broil Convection | 3                     | 435              | 225              | 9                   |
| <b>AIRFRYING</b>  |                 |                  |                       |                  |                  |                     |
| <b>POTATOES</b>   |                 |                  |                       |                  |                  |                     |
| Hash browns   | Single*         | Air Fry          | 3                     | 410              | 210              | 15-20               |
| Fries   | Single*         | Air Fry          | 3                     | 410              | 210              | 15-20               |
| <b>ONION RINGS</b>  | Single*         | Air Fry          | 3                     | 375              | 190              | 15-20               |
| <b>FISH</b>   |                 |                  |                       |                  |                  |                     |
| Battered/crumbed  | Single*         | Air Fry          | 3                     | 360              | 180              | 15-20               |
| <b>CHICKEN</b>  |                 |                  |                       |                  |                  |                     |
| Nuggets   | Single*         | Air Fry          | 3                     | 360              | 180              | 15-20               |

## COOKING CHARTS

| DEHYDRATING          | SHELVES | FUNCTION  | SHELF POSITION | TEMP (°F) | TEMP (°C) | TIME (HOURS) |
|----------------------|---------|-----------|----------------|-----------|-----------|--------------|
| <b>HERBS</b>         |         |           |                |           |           |              |
| Rosemary/dill/thyme  | Multi   | Dehydrate | 1 and 4        | 95        | 35        | 3-4          |
| <b>FRUIT</b>         |         |           |                |           |           |              |
| Apples/pears/bananas | Multi   | Dehydrate | 1 and 4        | 140       | 60        | 6-8          |
| <b>VEGETABLES</b>    |         |           |                |           |           |              |
| Carrots/beans        | Multi   | Dehydrate | 1 and 4        | 140       | 60        | 6-8          |
| <b>MEAT</b>          |         |           |                |           |           |              |
| Beef jerky           | Multi   | Dehydrate | 1 and 4        | 180       | 80        | 4-6          |

<sup>1</sup> Start at 430°F (220°C) for 10 minutes, and lower to 320°F (160°C) for further 50 minutes

<sup>2</sup> Brown in frying pan first

\* If multiple shelves are required (eg roasting vegetables at the same time), use **TRUE CONVECTION** and shelf positions 1 and 4.

\*\*Alternatively use the food probe and internal temperature settings or **COOK BY FOOD TYPE**.

# COOKTOP USE

## Selecting and using burners

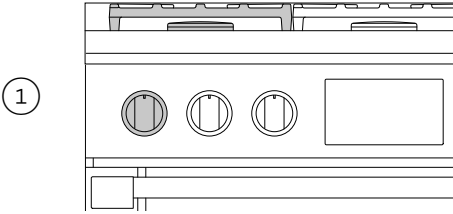

Identify the desired burner and the corresponding dial.

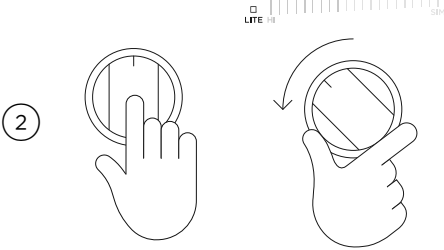

Push the dial in and turn counter-clockwise to **LITE**. Hold the dial at **LITE** before turning to a flame setting.

Note: You should hear a clicking sound when setting to **LITE**. If no clicking sound is present, turn the dial back clockwise to **OFF** and refer to 'troubleshooting' for advice.

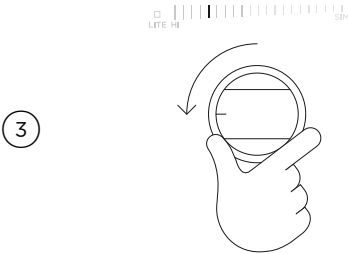

When the burner is lit, turn the dial to any setting between **HI** (high) and **SIM** (simmer).

Note: The clicking should stop as soon as the burner is lit. If the burner doesn't light, and/or the clicking doesn't stop, turn the dial clockwise back to **OFF** refer to 'troubleshooting' for advice.

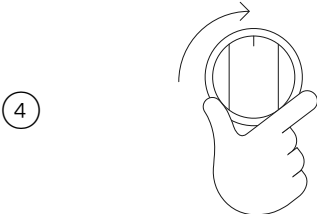

When you have finished cooking, turn the knob clockwise back to **OFF**.

If you are using LP gas, there may be a slight extinction pop or flash at the flame spreader a few seconds after the burner has been turned off. This is normal.

# COOKTOP USE

## Burner use guidelines

### Burner output

All burners have the same low turn-down setting (**SIM**) for gentle simmering (1,300 BTU/hr). Use **SIM** for melting chocolate and butter, cooking rice and delicate sauces, simmering soups and stews, and keeping cooked food hot.

For cooking that requires intense heat use the burners listed below. These have a higher maximum output (23,500 BTU/hr for Natural gas) than other burners (18,500 BTU/hr for Natural gas).

**RDV3-304 and RDV3-485GD models:** Center burner

**RDV3-488 and RDV3-366 models:** Front left or front right burner

**All other models:** Front left burner

### Use and care

- Never leave the cooktop unattended when in use. Boilover causes smoking and greasy spills that may ignite.
- Never allow flames to extend beyond cookware or curl up its sides. This could discolor and damage the utensil and you may get burned touching a hot handle.
- Keep handles out of the way. Turn handles so that they don't extend over the edge of the cooktop or another burner that is on.
- Take care when deep-frying. Oil or fat can overheat very quickly, particularly on a high setting.
- Make sure that all burner parts are correctly fitted. Incorrectly or incompletely assembled burners may produce dangerous flames. See 'Replacing the burner parts'.
- Keep the burners clean. Especially after a spill or boilover, ensure the affected burners are cleaned before using them again. Food residue may clog the ignitor and the notches of the flame spreader, stopping the burner from functioning correctly. See 'Care and cleaning' for instructions.
- Check that the burner flames are regular. They should be blue with no yellow tipping, and burn without fluttering around the burner cap. If not, see 'Troubleshooting' for advice.
- Use woks only with a wok ring. Wok rings can be purchased separately through your Fisher & Paykel dealer or Customer Care. To use, place the wok ring over the grates, making sure the small protrusions on its bottom straddle the grate fingers. The wok ring should be stable and unable to rotate.

## IMPORTANT!

### check pilots and burner flames

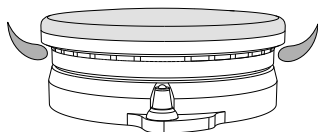

CORRECT

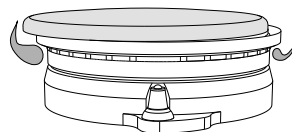

INCORRECT

## USER PREFERENCE SETTINGS

---

The settings menu allows you to adjust your user preferences to:

- Change the time
- Change the clock format (12 hours, 24 hours or off)
- Display the temperature in degrees Celsius or Fahrenheit
- Adjust the volume of audio feedback
- Turn timer alarms on or off
- Turn audio tones on or off
- Operate in Sabbath mode
- Change the language of the display
- Manage your WiFi connection
- Adjust the brightness of the display
- Restore all settings to factory original

### **IMPORTANT!**

- **You cannot change the settings when your oven is cooking or has any automatic cooking options set.**
- **Tones and alarms will still sound for faults if audio settings are turned off.**



# USER PREFERENCE SETTINGS

## Changing the settings

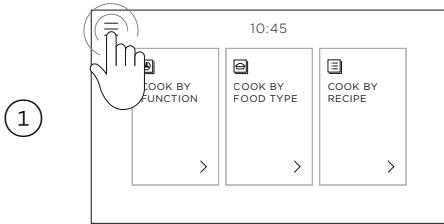

Touch the menu icon in the top left corner of the screen.

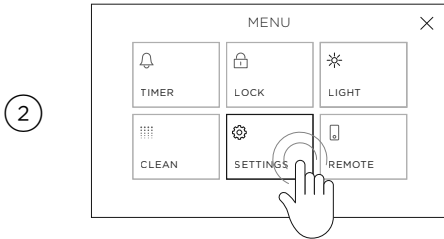

Select **SETTINGS**.

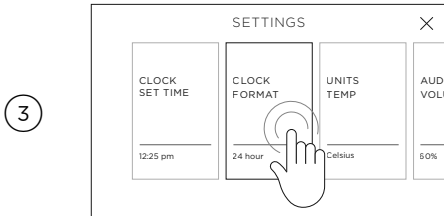

Select the setting you want to change, adjust as needed then select **CONFIRM**.

## WIFI CONNECTION AND REMOTE MODE

Your oven can be connected to your home wireless network and operated remotely using the FISHER & PAYKEL app.

### Getting started

- Ensure your home WiFi network is turned on.
- You will be given step by step guidance on both your oven and mobile device.
- It may take up to 10 minutes to connect your oven.

### Connecting to your home wifi

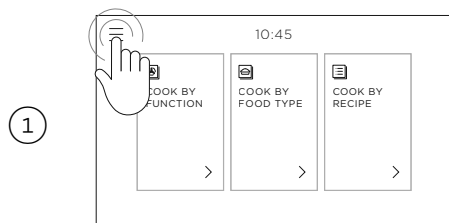

Touch the menu icon in the top left corner of the screen.

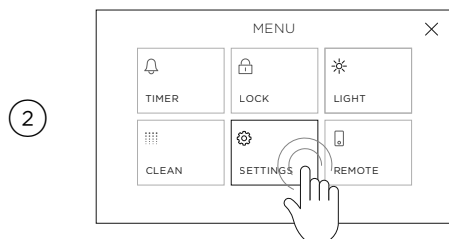

Select **SETTINGS**.

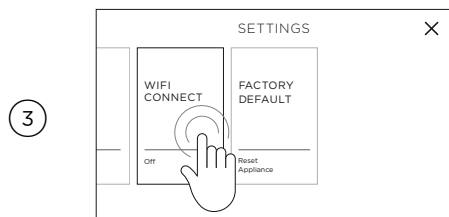

Select **WIFI CONNECT** and follow the onscreen guidance.

### On your mobile device:

- ① Download the **FISHER & PAYKEL** app from [www.fisherpaykel.com/connect](http://www.fisherpaykel.com/connect)
- ② Register and create an account.
- ③ Add your appliance and set up the WiFi connection.

# WIFI CONNECTION AND REMOTE MODE

## Enabling Remote Mode

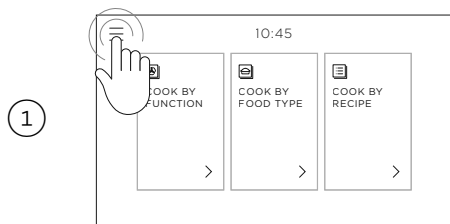

Touch the menu icon in the top left corner of the screen.

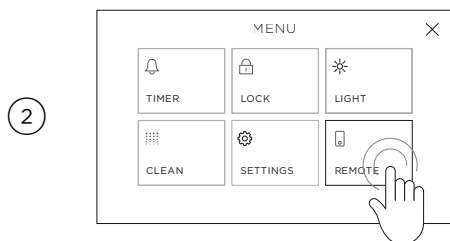

Select **REMOTE**.

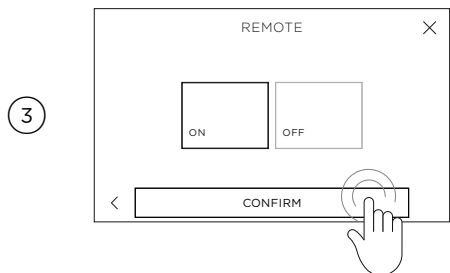

Select **ON** then press **CONFIRM**.  
**REMOTE MODE is now enabled.**

# SABBATH MODE

This setting is designed for religious faiths that observe a 'no work' requirement on the Sabbath.

While your oven is in Sabbath Mode it will not have the usual accurate temperature control:

| HEAT LEVEL | APPROXIMATE TEMP (°C) | APPROXIMATE TEMP (°F) | APPLICATION                  |
|------------|-----------------------|-----------------------|------------------------------|
| Low        | 75 - 100              | 170 - 210             | Keep hot food warm           |
| Moderate   | 155 - 180             | 310 - 360             | Reheat cooked food from cold |
| High       | 185 - 210             | 360 - 410             | Cooking raw food             |

## While your oven is in Sabbath Mode:

- the oven will not react to any actions
- lights, fans and display will not respond to the door opening
- if the door is open for too long, this may result in loss of temperature
- no tones or alarms will sound and alert codes or temperature changes will not be displayed
- the oven light can be set to remain either on or off
- the oven will remain in Sabbath Mode until cancelled
- **CLASSIC BAKE** is the only function available

## Setting Sabbath Mode

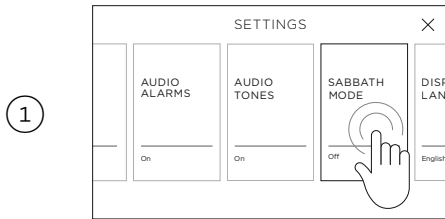

In the settings menu select **SABBATH MODE** and follow the instructions on the screen.

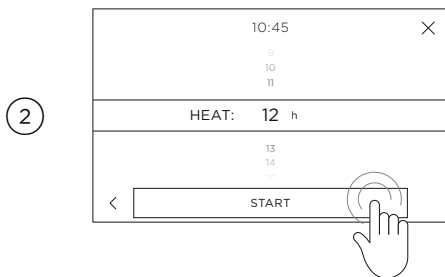

Set your desired heating level and select whether you want the oven light **ON** or **OFF** during cooking.

Scroll to set your desired cook time and then select **START**. You can set the oven to heat for up to 73 hours.

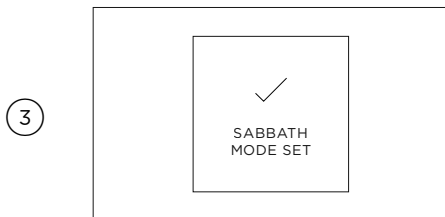

## Sabbath Mode is now set.

The oven will heat for the set length of time and then turn off.

The oven will remain in Sabbath Mode until it is cancelled.

# SABBATH MODE

---

## Cancelling Sabbath Mode

1

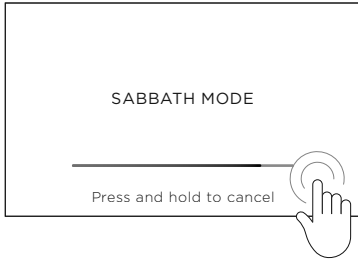

Touch and hold the screen until the bar fills.

2



**SABBATH MODE CANCELLED** will appear and you can now use your oven normally.

## CARE AND CLEANING

### ALWAYS

- Read these instructions and the 'Safety and warnings' section before you start cleaning your range.
- Before cleaning or removing any part, make sure that everything on the range has been turned off.
- Unless suggested otherwise in the chart following, allow any part to cool to a safe temperature before cleaning. If you do need to handle a warm or hot part take extreme care. Wear long protective mitts to avoid burns from steam or hot surfaces.
- Try using any cleaner on a small area first, to ensure it doesn't stain.
- See the pages following this chart for instructions on removing and replacing different parts of the range for cleaning or maintenance.
- Ensure the anti-tip device is re-engaged if you move the range for cleaning. Failure to do this may result in the oven tipping which may cause death.

### NEVER

- Use aerosol cleaners until the range has completely cooled. The propellant substance in these cleaners could catch fire in the presence of heat.
- Let soiling or grease accumulate anywhere in or on the range. This will make future cleaning more difficult and may present a fire hazard.
- Use any abrasive or harsh cleaners, cloths, scouring pads or steel wool. These will scratch your range and damage its appearance.
- Use a steam cleaner to clean any part of the range.
- Lift the black grill and griddle frames off the cooktop.

### Manual cleaning

| WHAT?  | HOW?   | IMPORTANT!   |
|--|--|--|
| <p>Door frame exterior</p> <p>Control panel</p> <p>Sump area around cooktop burners</p> <p>Back trim</p> | <ul style="list-style-type: none"> <li>• Soften any stubborn stains using a hot soapy cloth before cleaning with a solution of mild detergent and hot water. Wipe dry with a microfiber cloth.</li> <li>• For extra shine, use a suitable stainless steel cleaner and polish, following manufacturer's instructions. Always rub the stainless steel in the direction of the polish lines.</li> </ul> | <ul style="list-style-type: none"> <li>• Always read the label to ensure your stainless steel cleaner does not contain chlorine compounds as these are corrosive and may damage the appearance of your cooktop.</li> <li>• Do not use stainless steel cleaner on the dials, oven handles, or the toe kick. These are not stainless steel parts and their surface may be damaged by stainless steel cleaner.</li> <li>• When cleaning the back trim and the top of the oven door, ensure liquid does not run down the vents.</li> </ul> |
| <p>Control dials</p> <p>Oven handles</p> <p>Toe kick</p>   | <ul style="list-style-type: none"> <li>• Wipe with a damp cloth using a solution of mild detergent and hot water then dry thoroughly with microfiber cloth.</li> <li>• If desired, the dials can be removed for cleaning. Before removing, ensure that dial is set to <b>OFF</b>. Remove only one dial at a time ensuring that you refit completely and correctly.</li> </ul>                        | <ul style="list-style-type: none"> <li>• Do not use stainless steel cleaner on these parts, as doing so may damage their coating.</li> <li>• The dials are not interchangeable: if removed for cleaning, do so one at a time. This is to ensure that they are replaced correctly.</li> </ul>   |

## CARE AND CLEANING

| WHAT?  | HOW?   | IMPORTANT!  |
|--|--|---|
| <b>Enamel oven interior – light soiling</b>    | Wipe with a damp cloth and a solution of hot water and mild detergent then dry with a soft cloth.<br>Note: the oven door may be removed for ease of access.  | <ul style="list-style-type: none"> <li>To prevent soiling from becoming 'baked on', we recommend removing any easy-to-reach spills, from the enamel after each use.</li> <li>This will reduce the need for using the <b>SELF CLEAN</b> cycle frequently.</li> </ul> |
| <b>Enamel oven interior – stubborn soiling</b> | Use the <b>SELF CLEAN</b> cycle. See 'Using Self Clean' for instructions.  | Don't use oven cleaners in the cavity. Oven cleaners are caustic and may permanently stain or damage some surfaces.   |
| <b>Side racks</b>                              | Pre-soak any stubborn, soiling, then clean with a solution of mild detergent and hot water and wipe dry with a microfiber cloth. These parts are dishwasher safe                                       |   |
| <b>Oven shelves</b>                            | To remove stubborn soiling, scrub with a damp, soap-filled, non-abrasive pad, then wipe dry. Apply a chrome cleaner with a damp sponge or cloth following manufacturer instructions. the wipe and dry. | Do not wash the main oven shelves in the dishwasher - doing so will remove the lubricating grease in the slides, stopping them from running smoothly.   |
| <b>Broil pan and rack</b>                      | Pre-soak any stubborn soiling in a solution of mild detergent and hot water. Wash by hand or in a dishwasher.  |   |
| <b>Burners</b>                                 | Do not clean these parts. They self-clean during normal use.   |   |
| <b>Oven door glass (interior)</b>              | This will be cleaned during a <b>SELF CLEAN</b> cycle. Wipe down with hot water to loosen stains before starting <b>SELF CLEAN</b> .   | Do not use oven cleaners or any other harsh/abrasive cleaners, cloths, scouring pads to clean These scratch the glass, which can result in the glass cracking and shattering.   |
| <b>Oven door glass (exterior)</b>              | Clean using a soft cloth and a mixture of warm water and dishwashing liquid or glass cleaner.  |   |
| <b>Oven door gasket</b>                        | Avoid cleaning this part. To remove large food particles, dampen a sponge with hot water and gently wipe — do not rub. Press a towel gently on the gasket to dry.                                      | Do not use any cleaning agent on the gasket. The gasket is essential for a good seal. Take care not to rub, displace, or damage it.   |

## CARE AND CLEANING

| WHAT?  | HOW?   | IMPORTANT!  |
|--|--|---|
| <b>Burner caps and brass flame spreaders</b>                     | Ensure the burner is turned <b>OFF</b> and cool. Lift off the burner cap and brass flame spreader and wash in hot soapy water. Rinse and dry. Use a stiff nylon brush or straight-ended paper clip to clear the notches of the flame spreader. Replace the flame spreader and burner cap correctly. See 'Replacing the burner parts'.      | Keep the notches of the flame spreaders clear. Soiling may clog these and cause ignition problems. Before replacing the burner parts, ensure they are dry. Wet burner parts may result in an irregular flame. Before lighting a burner, ensure all parts are positioned correctly. Incorrect assembly can cause dangerous irregular flames and ignition problems. |
| <b>Ignitors</b>  | Ensure the burner is turned <b>OFF</b> . Clean the ignitor with a small brush or cotton swab that has been dipped into rubbing alcohol.  | The ignitors must be kept clean and dry to work correctly. Dirty or wet ignitors could cause constant clicking and sparking, even if a flame is present.  |
| <b>Burner grates</b><br><b>Wok ring</b><br><b>(not supplied)</b> | Ensure grates/wok ring has cooled completely before carefully lifting them off the cooktop. Place on a protected surface. To remove stubborn stains, soak the grates in a mixture of clothes detergent and water. Wash in a mixture of hot water and dishwashing liquid, then rinse and allow to dry. The grates are also dishwasher safe. | Take care, the grates are heavy. Ensure you place a dish towel or other soft cover on the surface before putting a grate on it.   |



## CARE AND CLEANING

### Removing the side racks

Remove the side racks to make cleaning the oven easier. The side racks must be removed before using the **SELF CLEAN** function.

### **IMPORTANT!**

**Always turn the oven off at the wall first. Ensure the oven has cooled down completely before starting.**

1

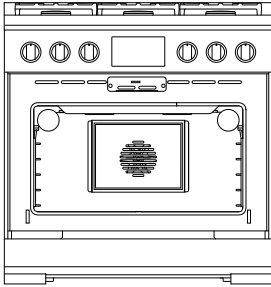

Slide out all shelves and remove.

2

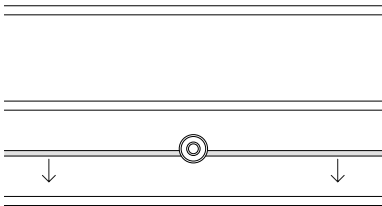

Gently pull down on the retaining wire from underneath the lock stud. The retaining wire will pop out. Unscrew the fixing nut and set aside.

3

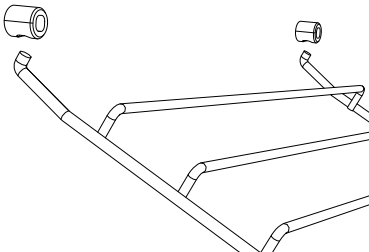

Swing the bottom of the side rack up towards the center of the oven until it is almost horizontal. Slide the prongs at the top out of the mounting slots.

## CARE AND CLEANING

### Refitting the side racks

#### **IMPORTANT!**

Always turn the oven off at the wall first. Ensure the oven has cooled down completely before starting.

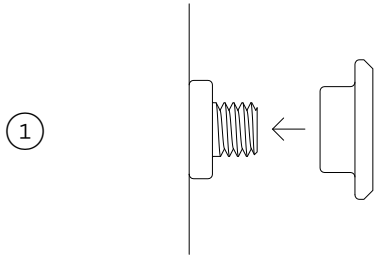

Refit the fixing nut, ensuring it is fully tightened.

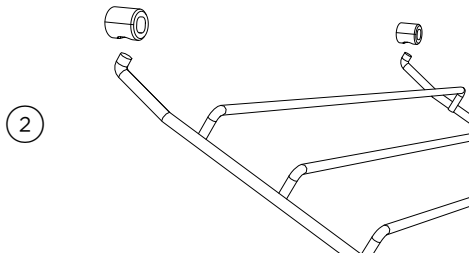

Supporting the side rack from underneath, hold it almost horizontally and locate the prongs into the mounting slots.

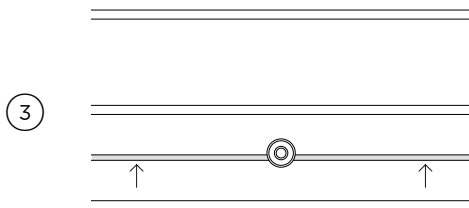

Ensure the prongs are fully inserted into the slots, then lower the side rack carefully and gently push the retaining wire underneath the lock stud.

## CARE AND CLEANING

---

### Replacing the oven light bulbs

#### **IMPORTANT!**

Use a 40 W, 120 V appliance light bulb for replacement. Do not use a standard light bulb in any oven, the heat will break it.

#### Changing the bulb

- ① Allow the oven (including the lamp cover and the bulb) to cool completely.
- ② Remove any shelves that may get in the way.
- ③ Remove the door if the lamp will be hard to reach.
- ④ Turn the power supply to the range off at the main fuse or circuit breaker panel. If you don't know how to do this, contact an electrician.

#### **IMPORTANT!**

Failure to disconnect the range from the power supply may result in death or electrical shock.

- ⑤ Remove the lamp cover: turn it counterclockwise to unscrew.
- ⑥ Remove the faulty bulb and replace with a new 40 W appliance light bulb.
- ⑦ Replace the lamp cover: turn it clockwise to tighten.
- ⑧ Turn the power supply to the range back on at the main fuse or circuit breaker panel.

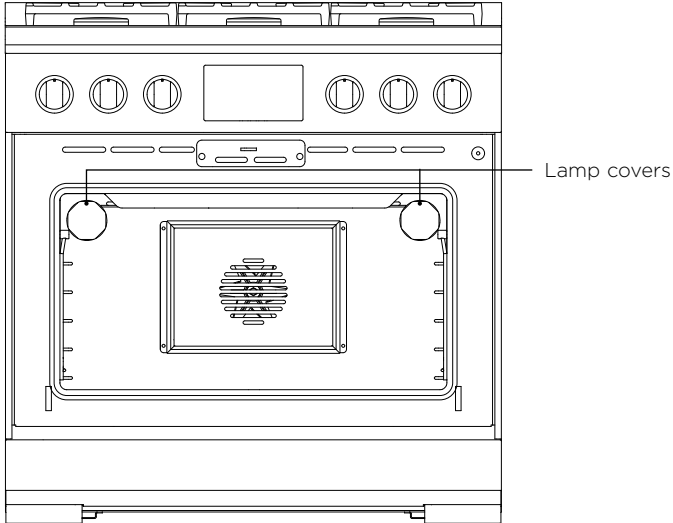

## CARE AND CLEANING

---

Removing and refitting the oven door.

### IMPORTANT!

- Take care, the oven door is heavy.
- Do not lift the oven door by its handle. Doing so may damage the door.
- Ensure the oven and the door are cool before you begin to remove the door.
- Before removing the door, ensure there is a large enough clear, protected surface in the kitchen to rest the door on.

To remove the door

①

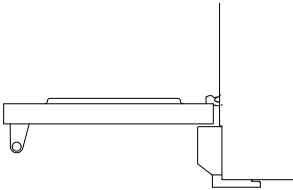

Open the door completely.

②

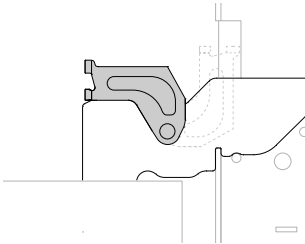

Open the hinge locks fully on both sides

③

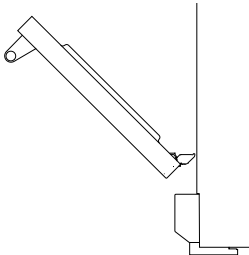

Holding the door on both sides, lift door back up to 45° and carefully pull the door out and away from the hinges.

## CARE AND CLEANING

### To refit the door

1

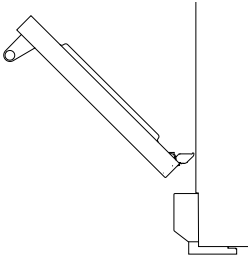

Holding the door at 45°, carefully align the hinge tongues with the hinge slots. Push the door in until you feel the latches locate into position on each side

2

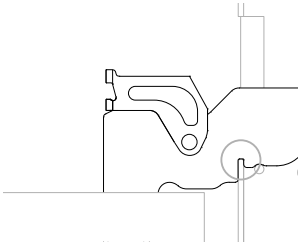

Open the door completely and ensure both hinges are secured by the correct notches.

3

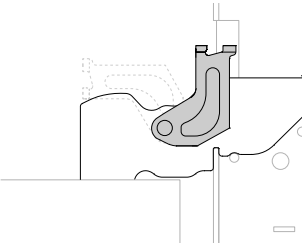

Rotate the locks up into the closed position ensuring they rest inside the slots completely. Note: Incorrect installation will prevent door from correctly sealing.

4

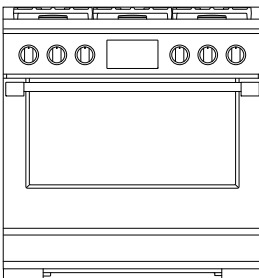

Close the oven door ensuring that when closed, the door is vertical and parallel to any surrounding cabinetry

## CARE AND CLEANING

---

### Replacing burner parts

#### **IMPORTANT!**

When replacing the burners, ensure the two locating pins on the bottom of the brass flame spreader are correctly aligned with the locating pin holes on the top of the simmer ring. Incorrect alignment will produce a potentially dangerous flame and cause poor burner performance.

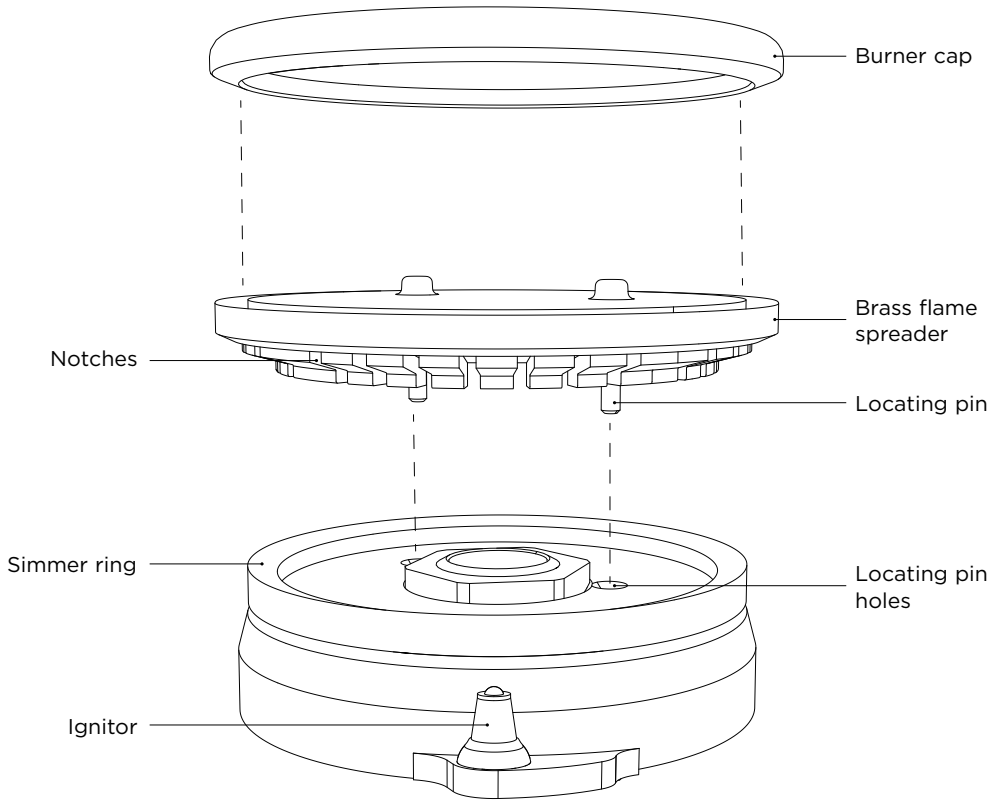

## USING SELF CLEAN

Self Clean takes care of the mess and grime that is traditionally associated with oven cleaning. The extremely high temperature of the pyrolytic clean cycle burns off and breaks down grease and grime deposits. All that is left is a small amount of ash that can easily be wiped up.

There are two clean cycles available:

**STANDARD CLEAN** (5hr, 20min)  
For normal or heavy soiling

**LIGHT CLEAN** (4hr, 20min)  
For light soiling

### IMPORTANT!

- You must clean the inside glass door panel **BEFORE** starting a clean cycle. Failure to do so may result in permanent staining or marking of the door glass. See 'Care and cleaning' for our recommendations on how to do this.
- Do not use oven cleaners, any degreasing cleaners, or oven liners.
- Remove all oven shelves, racks, trays, bakeware and utensils from the oven before starting a clean cycle. If left in the oven they will be permanently damaged; items made from combustible material (eg wood, fabric, plastic) may even catch fire.
- Do not use your oven to clean miscellaneous parts.
- Make sure the room is well ventilated.
- Before starting a clean cycle, make sure you move any pet birds to another, closed and well-ventilated room. Some pet birds are extremely sensitive to the fumes given off during a clean cycle, and may die if left in the same room.
- During a clean cycle, the oven reaches higher temperatures than it does for cooking. Under such conditions, the surfaces may get hotter than usual and children should be kept away.
- The oven door will be locked during the clean cycle.
- If there are cracks or flaws on any of the oven door glass panes, if the oven seal is damaged or worn, or if the door does not close properly, do not start a clean cycle. Contact a Fisher & Paykel trained and supported service technician or Customer Care.

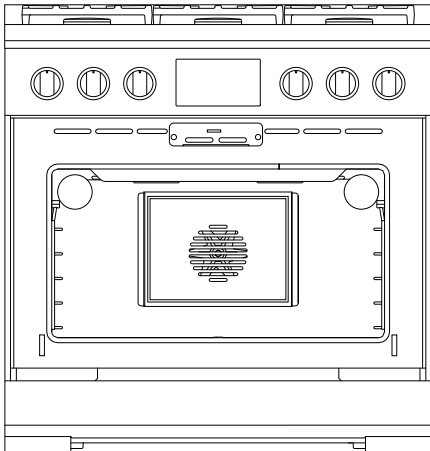

### Before you start

- ① Remove all shelves, accessories and utensils. You do not need to remove the side racks.
- ② Wipe up any spills, and along the inner edge of the oven surface around the seal. Failure to do so may discolor the oven surface.

**Avoid cleaning the seal itself as this may cause damage.**

- ③ Check the inner glass pane of the oven door. If it has soiling on it, you will need to clean it manually before starting a Clean cycle. For instructions, see 'Care and cleaning'.

**If soiling is left on the glass, it will become burnt on during the clean cycle, making it very difficult to remove.**

- ④ Close the oven door firmly.

## Setting Self Clean



Touch the menu icon in the top left corner of the screen.

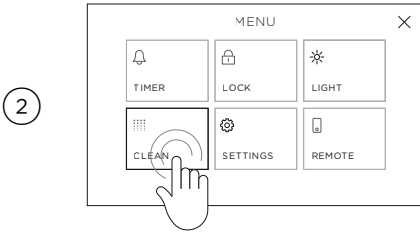

Select **CLEAN**.

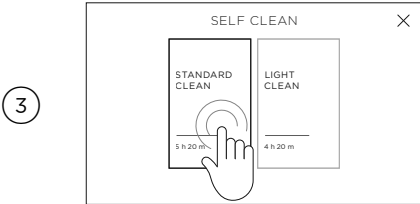

Select **STANDARD CLEAN** or **LIGHT CLEAN**.



Follow the on-screen instructions and press the button to the right of the screen to continue.



Press the button to the right of the screen to start the clean cycle.

For your safety, the oven door will be locked shut during the cycle. If the door is not shut properly or is reopened before **SELF CLEAN** starts, the cycle will be cancelled.



## USING SELF CLEAN

### Cancelling Self Clean

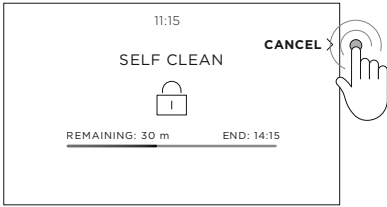

Press the button to the right of the screen at any point during the clean cycle to cancel.

### IMPORTANT!

- The oven door will not unlock until the oven has cooled to a safe temperature.  
**DO NOT** turn off the mains power supply to the oven (wall switch). Turning off the power while the oven is too hot may damage the oven and its surrounding cabinetry.
- We do not recommend cancelling Self Clean then immediately starting another cycle.

### When Self Clean is finished



**SELF CLEAN COMPLETE** will show in the display. Touch the display to clear.

### You need to:

- wait for the oven to cool down completely
- remove the grey ash with a small brush or damp cloth
- wipe out the oven with a clean, damp cloth
- dry with a clean, lint-free cloth, and
- replace the oven shelves.

## TROUBLESHOOTING

If there is a problem with your oven, please check the following points before contacting your local Fisher & Paykel trained and supported service technician or the Customer Care Centre.

### General

| PROBLEM  | POSSIBLE CAUSES   | WHAT TO DO  |
|--|---|---|
| The oven does not work (no heating)  | No power supply (oven light and dial halos do not come on)  | Ensure the circuit breaker hasn't tripped and there is no power outage in your area. If there is a power outage, you cannot use the oven until power is restored. |
|  | No gas supply   | The supply to the house may be faulty or there may be an outage. Contact your local gas supplier.   |
| The oven does not work but the screen is on.                                     | The oven is in Demo Mode.   | Call Customer Care.   |
| One of the oven lights does not come on, but the oven works.                     | The oven light bulb(s) have blown   | Replace the light bulb(s). See 'Care and cleaning' for instructions.  |
|  | The light bulb is loose.  | Ensure bulb is secure See 'Care and cleaning' for instructions.   |
|  | The oven light has been turned off.   | Go to the menu in the top left corner of the screen and select <b>LIGHT</b> .   |
| The oven controls are unresponsive.  | The control panel is locked.  | Touch and hold the screen to unlock.  |
| The oven is not heating.   | The door is not properly closed or it is opened too frequently during cooking.  | The heating elements are disabled while the door is open. Ensure the door is properly closed and avoid opening it during cooking.                                 |
| A glass pane in the oven door has cracked, chipped, or shattered.                | Incorrect cleaning or the edge of the glass hitting against something.  | You must <b>NOT</b> use the oven. Contact a Fisher & Paykel trained and supported service technician or Customer Care   |
| I can feel hot air blowing out of the vents after I have turned the oven off.    | This is normal.   | For safety reasons the cooling fans will continue to run even when you have turned the oven off. The fans will switch off automatically when the oven has cooled. |
| The oven fan comes on when I select a function that does not use a fan (eg BAKE) | This is normal. The fan comes on while the oven is preheating. It may turn off when the oven has reached the set temperature. | Wait until the red heating bar on the screen disappears: the oven will then be ready to use.  |

## TROUBLESHOOTING

### General

| PROBLEM   | POSSIBLE CAUSES  | WHAT TO DO   |
|---|--|--|
| The oven fan comes on when I select a function that does not use a fan (eg BAKE)      | When heating from cold, your oven is designed to initially heat to a temperature higher than what is set.  | Wait until the red heating bar on the screen disappears: the oven will then be ready to use.                         |
| The oven has reached the set temperature but the temperature dial halo is still red.  | The oven is set to <b>MAXI BROIL</b> .   | This is normal. The dial halo will stay red whenever this function is in use as the broil element is always heating. |
| The oven sounds a tone when I try to set the temperature below a certain temperature. | This is normal: for food safety reasons, the oven functions have factory-set minimum temperature settings. | Select a different temperature or try a different function that is designed for low temperatures.                    |
| The temperature dial halo never turns white when I use BROIL.                         | This is normal: the halo stays red to indicate that the broil element provides instant radiant heat.       |  |
| Fan noise and warm air coming from the range during and after use.                    | A cooling fan in the range runs to prevent the oven door and control panel from overheating.               | This is normal and requires no action.   |
| Condensation around oven (eg on control panel or top of oven door.)                   | Food has high moisture content or the local climate is contributing to condensation.                       | If there is frequent or excessive condensation, ensure that cabinetry around the range is moisture-proof.            |
| Steam coming from vents at the back of the range.                                     | Moisture from food evaporating during cooking.   | This is normal, especially if you are cooking large quantities of food using a <b>CONVECTION</b> mode                |
| The oven door does not align with the control panel or cabinetry.                     | The oven door has been installed incorrectly and the hinges are misaligned within the slots.               | Re-install the door. See 'Care and cleaning' for instructions.   |
| Temperature is not calibrated correctly.  | Door is not sealing correctly.   | Re-install the door. See 'Care and cleaning' for instructions.   |
| The fan does not come on in a convection mode.  | Technical fault  | Contact your Authorized Service Center or Customer Care.   |
| Uneven baking   | Oven not correctly preheated.  | Ensure the dial halo has changed to red before beginning.  |
|   | Unsuitable or incorrectly arranged bakeware.   | See 'Cooking guide' for advice.  |
| The halo around the dial alternates between white and orange during use               | The oven needs to heat periodically to maintain the set temperature during use                             | This is normal.  |

## TROUBLESHOOTING

### Self Clean

| PROBLEM  | POSSIBLE CAUSES   | WHAT TO DO  |
|--|---|---|
| During Self Clean, the oven is louder than usual.  | This is normal: the oven's cooling fans operate at their highest speed.   |   |
| The screen shows no time remaining but the oven door will not open.  | The oven door is locked because the oven is still too hot to be used for cooking.                                       | Wait until Self Clean has finished. If you cancelled a cycle part way through, the oven still needs to cool down before it can be used. The oven door will automatically unlock.  |
| I have cancelled Self Clean but cannot use the oven: <ul style="list-style-type: none"> <li>• the door will not open</li> <li>• the screen is still counting down or showing no time remaining</li> <li>• the controls are unresponsive</li> </ul> | This is normal. If the oven is still too hot to be used for cooking the door will stay locked until it has cooled down. | Wait until the cool-down phase has finished. A long tone will sound and the oven door will automatically unlock when the oven is ready to use.<br><br>Depending on when the clean cycle was cancelled, the cool-down may take up to 45 minutes. |
| The oven screen shows A2 or A3.  | See section 'Alert codes' for instructions.   | Follow the instructions on the screen.  |
| There is a power cut during Self Clean.  | Power cut.  | The heating elements are disabled while the door is open. The door will remain locked until the oven has cooled to a safe temperature.  |
| Excessive smoking and/or flames inside the oven during a CLEAN cycle.  | Combustible material (eg wooden board or utensil) or excessive food soils left in the oven.                             | Follow the instructions under 'Self Clean' Do not disconnect the range from the power supply at the circuit breaker. The cooling fan is needed to cool the range.   |
| Brief glowing inside the oven during SELF CLEAN.   | Heavy soiling is being removed  | This is normal and requires no action.  |
| The dial halos on the secondary oven flash white   | SELF CLEAN is running in the main oven  | Wait until the SELF CLEAN cycle has finished or follow the instructions in 'Using Self Clean'.  |
| The dial halos on the main oven flash red  | The secondary oven is in use  | A SELF CLEAN cycle cannot run when the secondary oven is in use. Turn the dials of the secondary oven to OFF.   |
| The oven door won't open   | The door is locked because SELF CLEAN cycle is underway or the oven has not yet cooled.                                 | See instructions in 'Using Self Clean'.   |

## TROUBLESHOOTING

### Cooktop burners

| PROBLEM   | POSSIBLE CAUSES   | WHAT TO DO  |
|---|---|---|
| The ignitor keeps clicking (continuous spark) even when a burner has lit.   | Dirty or wet ignitor(s)   | Clean the ignitor(s). See 'Care and cleaning' for instructions.   |
| None of the burners will light.   | No power supply   | Check that there is no power outage in your area and that the power supply to the range is switched on at the circuit breaker panel.  |
|   | No gas supply   | Check that the gas supply to the house is working. You should hear the gas when you turn a burner on. If you are using bottled gas, check that it is not empty.   |
| Some burners will not light - Flames do not burn all around the burner cap. | Burner parts or ignitors may be wet, dirty, or misaligned                   | Check that the burner parts are clean, dry, and correctly assembled. Ensure the ignitors are clean and dry. See 'Care and cleaning' for instructions.   |
| There is no clicking when I try to light a burner                           | The ignitor is dirty or there is a power outage                             | Clean the ignitor(s). See 'Care and cleaning' for instructions.   |
| There is a slight 'extinction pop' or flash after I've turned a burner off. | This is normal for LP gas and requires no action.                           |   |
| The flames have suddenly gone out.  | A draft or a spill has extinguished the flame                               | No action required. The burner will detect this and automatically relight. However, if there has been a large spill, we recommend turning the burners off and cleaning the burners and sump area. See 'Care and cleaning' for instructions. |
| The burner flames are uneven, very large, yellow or yellow-tipped or sooty. | Technical fault: the gas is the wrong type or hasn't been adjusted properly | Do not use your cooktop burners. Contact your Authorized Service Center or Customer Care.   |
| There is a power failure - can I still use the cooktop burners?             | The cooktop burners can still be used.                                      | If the flame is blown out during a power failure, turn the dial to <b>OFF</b> , as the burner will not automatically relight and gas may escape.  |

## ALERT CODES

If there is a problem, the oven will automatically suspend all oven functions, beep five times and display an alert code.

### IMPORTANT!

**Do not turn off the mains power supply to the oven (wall switch) if you get an alert code, unless the instructions in the chart following specifically instruct you to. There are cooling fans within the oven which are needed to cool the oven's components. Turning off the power while the oven is too hot may damage the oven and its surrounding cabinetry.**

#### What to do if an alert code is displayed

- ① If the beeping hasn't stopped already, touch the display and press the little audio button in the bottom right to mute it.
- ② Make a note of the alert code displayed. You may need this information.
- ③ Follow the instructions on the screen to resolve the problem.
- ④ If you can fix the problem and the alert code does not reappear, you may continue using your oven.

If you can't fix the problem yourself or the alert code reappears and the problem persists: wait until the cooling fans have stopped and the oven has completely cooled down, then turn the power to the oven off at the wall and contact a Fisher & Paykel trained and supported service technician or Customer Care with the alert code information.

| ALERT CODE           | POSSIBLE CAUSES   | WHAT TO DO  |
|----------------------|---|---|
| <b>A1</b>            | The oven has overheated.  | <ul style="list-style-type: none"><li>• Allow the oven to cool down.</li><li>• Once the oven has cooled down and the door has unlocked, the alert code will disappear. You can now use the oven.</li></ul>  |
| <b>A2</b>            | Door lock error: the door cannot be locked after you have started a Self Clean cycle. | <ul style="list-style-type: none"><li>• Turn the power to the oven off at the wall and on again.</li><li>• Wait approximately 10 seconds. This will allow the door lock to return to its initial position.</li><li>• Set the clock. See 'Setting the clock and first use' for instructions.</li><li>• Try starting a Self Clean cycle again, making sure that you close the door firmly. See 'Using the Self Clean function'.</li></ul> |
| <b>A3</b>            | Door lock error: the door cannot be unlocked after a Self Clean cycle has finished.   | <ul style="list-style-type: none"><li>• Turn the power to the oven off at the wall and on again.</li><li>• Gently press the door a few times to help the door lock disengage.</li><li>• If this doesn't help and the alert code reappears, contact a Fisher &amp; Paykel trained and supported service technician or Customer Care.</li></ul>   |
| <b>F</b><br>+ number | Technical fault.  | <ul style="list-style-type: none"><li>• Note down the alert code.</li><li>• Wait until the cooling fans have stopped and the oven has completely cooled down.</li><li>• Turn the power to the oven off at the wall.</li><li>• Contact a Fisher &amp; Paykel trained and supported service technician or Customer Care.</li></ul>  |

## WARRANTY AND SERVICE

---

### Before you call for service or assistance

Check the things you can do yourself. Refer to the installation instructions and your user guide and check that:

- Your product is correctly installed.
- You are familiar with its normal operation.

If after checking these points you still need assistance or parts, please refer to the Service & Warranty book for warranty details and your nearest Service Center, Customer Care, or contact us through our website [www.fisherpaykel.com](http://www.fisherpaykel.com)

Complete and keep for safe reference:

|               |       |
|---------------|-------|
| Mode          | _____ |
| Serial No.    | _____ |
| Purchase Date | _____ |
| Purchaser     | _____ |
| Dealer        | _____ |
| Suburb        | _____ |
| Town          | _____ |
| Country       | _____ |

**FISHERPAYKEL.COM**

© Fisher & Paykel Appliances 2019. All rights reserved.

The product specifications in this document apply to the specific products and models described at the date of issue. Under our policy of continuous product improvement, these specifications may change at any time. You should therefore check with your Dealer to ensure this booklet correctly describes the product currently available.

**US CA**

**592030B 10.19**