

FALCON

*Falcon
Monarch
Dor-O-Matic*

B Series

Medium Duty, Grade 2 Cylindrical Lever Locks



THE FALCON DIFFERENCE

S A F E T Y , S E C U R I T Y A N D U N C O M P R O M I S I N G V A L U E

At Falcon, we know that every product you sell not only has to meet local building codes, but also your expectations for performance and quality. We take your expectations seriously, and that's why we build our locks to deliver durability, convenience and unmatched value. After all, we've built our reputation on the same standards that you have – providing quality products at a reasonable price delivered on time. It's the way we do business and it's what makes Falcon locks a powerful choice no matter what your project.



FALCON B SERIES

When you need a tough, reliable lock for a government/military, retail, industrial or multi-family project, you need a Falcon B-Series lock. Our full line of Grade 2 locksets are a perfect replacement for existing locks, or a smart spec in new construction. With upgraded finishes these locks deliver style as well as strength. Falcon B-Series locks feature an interchangeable core that can be removed for quick, easy re-keying, and are compatible with SFIC products from other manufacturers. Most important, they're backed by one of the best names in the business.

FEATURES



Heavy wrought brass or bronze roses over steel through-bolted rose inserts

UL Listed 1-1/2 hour

Cylinder housings and plugs machined from solid brass

Brass or cold-formed steel construction with zinc dichromate plating for rust resistance

FALCON B SERIES

LOCK FEATURES AND SPECIFICATIONS

Lock Features

Door Thickness: 1-3/8" to 2" standard.

Backset: 2-3/4" standard. 2-3/8" also available.

Mechanism: Parts constructed of brass or cold formed steel, zinc plated and dichromated for rust resistance. Springs are stainless steel.

Attachment: Lock chassis secured to door by two screws which pass through a steel rose insert inside and thread directly into the outer rose mounting assembly.

Handing: Locks are non-handed.

Cylinders: Drilled with 6-pin chambers, pinned in 5. Pinning in 6 chambers available when specified, at no cost. Cylinder assemblies removable to rekey. Also available with 6 or 7-pin interchangeable core cylinders. Cylinder housings and plugs machined from solid brass. Springs are phosphor bronze. Two nickel silver keys furnished standard.

Competitor Cylinders: The B Series accepts these standard 6-pin cylinders: Assa, Kaba, Loric, Medeco, Primus and Schlage.

Keywords: "G" keyway standard on standard cylinders. "A" keyway standard on I/C core cylinders. Also available with some optional keyways. See page 9.

Trim: Roses are 3-1/2" diameter, heavy wrought brass or bronze, installed over steel rose inserts which are through-bolted through door. Levers are pressure cast zinc (solid levers-no inserts) material finished to match mating parts.

Latches: 1/2" bolt projection. UL (3-hour, A Label) listed. Latches have self-adjusting fronts to accommodate beveled or flat doors. 2-3/8" backset with 2-1/4" x 1" latchfaces, 2-3/4" backset with 2-1/4" x 1-1/8" latchfaces. Deadlocking latches have a solid round bar stock DL bar preventing latch jamming and/or lock outs.

Strikes: 4-7/8" x 1-1/4" ANSI strike with curved lip to meet ANSI A115.2 door frame preparation standard. Consult Options and Accessories section for other available strike size and configurations.

Screws: Furnished with combination screws for use in wood or metal doors and frames.

ANSI/BHMA: Exceeds ANSI/BHMA A156.2, Series 4000, Grade 2.

UL: 3-hour, A Label.

Falcon Lock B Series Specifications

Key-in-lever cylindrical locksets shall be Falcon B Series or equal and meet the following requirements:

- All locks shall meet the new ANSI/BHMA A156.2, Series 4000, Grade 2 test requirements for key-in-lever locksets.
- Locksets shall be UL Listed 3-hour, A Label.
- Lever trim shall have individual heavy-duty springs for lever return and to prevent lever sag. Trim shall be through-bolted with screws coated with thread sealant to provide strength and resistance to loosening.

- Roses shall be 3-1/2" diameter.
- All lever designs shall be solid (no inserts) and meet the federal ADA and state disability requirements.
- Locksets shall adjust to fit door thickness from 1-3/8" to 2".
- All locksets shall be non-handed and not require field disassembly for re-handing.
- Preparation for door must be non-handed.

Acceptable manufacturer: **FALCON LOCK**

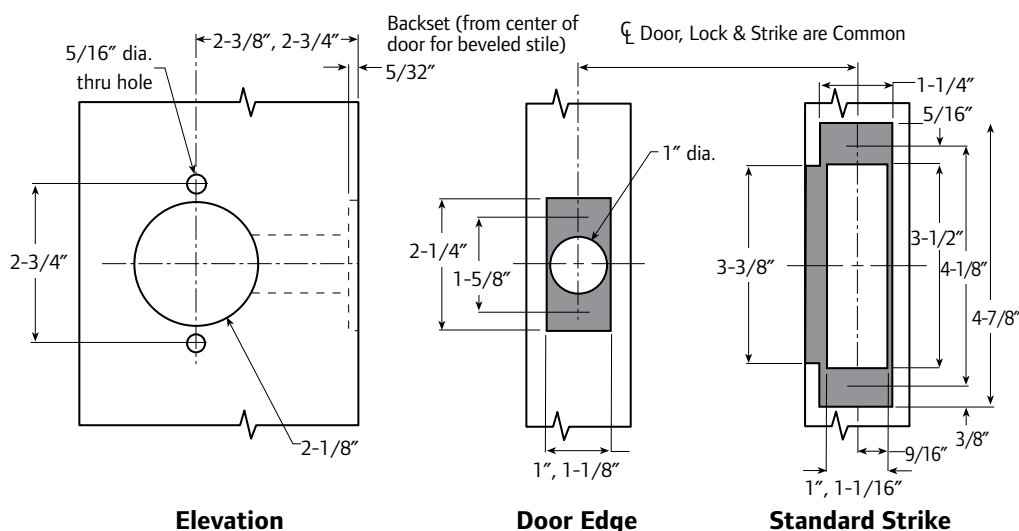

Levers

Levers are solid pressure cast zinc, finished to match mating parts. Roses are wrought brass or bronze installed over steel through-bolted rose inserts. Levers are secured by a spring-loaded retainer. Retainer in keyed lever cannot be depressed without key.

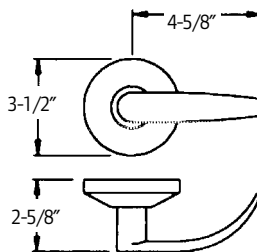
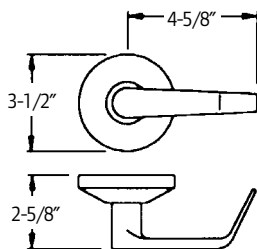

Abrasive Strip Levers











All levers are available with an abrasive strip along the inside length of the lever to identify entrances that may be hazardous to the handicapped. To order, change trim designation to: 6DA (DANE) or 6QU (QUANTUM) in trim section of order. Not available on 613 finish as abrasive strip will not hold.



FALCON B SERIES FUNCTIONS

To order Falcon B Series locksets, please consult page 11 for ordering information and assistance.

⌋ Indicates interchangeable core available.

Catalog Number	Function	Description	ANSI Number & Grade
B101		Passage/Closet Latchset Latch bolt by levers at all times.	F75-2
B161		Communicating/Exit Latch Deadlocking latch bolt by inside lever. Non-removable blank plate outside.	
B301		Privacy Lock Latch bolt by levers. Outside lever locked by push button in inside lever. Rotating inside lever or closing door releases push button. Emergency release in outside lever unlocks door.	F76-2
B341		Connecting Room/Exit Lock Deadlocking latch bolt by inside lever except when locked by key. Non-removable blank plate outside (22/32" projection).	
B501		Entry Lock Push button locking. Button on inside locks outside lever until unlocked by key or by rotating inside lever. Inside lever always free. Deadlocking latch bolt.	F82-2
B511		Entry/Office Lock Turn/push button locking. Pushing and turning button locks outside lever requiring use of key until button is manually unlocked. Push button locking. Pushing button locks outside lever until unlocked by key or by rotating inside lever. Inside lever always free. Deadlocking latch bolt.	F109-2
B561		Classroom Lock Deadlocking latch bolt by levers. Outside lever is locked by key in outside lever. Inside lever is always free.	F84-2
B581		Storeroom Lock Deadlocking latch bolt by lever inside or key outside. Outside lever is rigid. Inside lever is always free.	F86-2
B611		Assisted Living Lock Deadlocking latch bolt by levers except when locked by push button on inside lever. Key in outside lever locks or unlocks outside lever and releases button. Closing door releases push button. Inside lever is always free.	
B12		Dummy Trim Single Trim. Surface mounted rigid lever.	

Dust Boxes

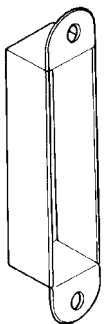

K510-066-PLA (EC 3604)
1" deep. May be used with any 4-7/8" high (ANSI) strike.

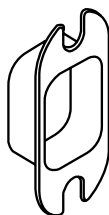

012191-003-70
1/2" deep. May be used with any 2-3/4" high (T) strike.

FALCON B SERIES CYLINDERS FOR COMPETITOR KEYWAYS OPTIONS AND ACCESSORIES

Falcon Interchangeable Cores

Catalog Number	Description
C606	For use in all B Series I/C Keyed Locks (cover style)
C607	For use in all B Series I/C Keyed Locks (cover style)
CB806	For use in all B Series I/C Keyed Locks (cap style)
CB807	For use in all B Series I/C Keyed Locks (cap style)

Note: Specify finish: 606 or 626.

Specify keyway: "A" (standard) or other keyway.

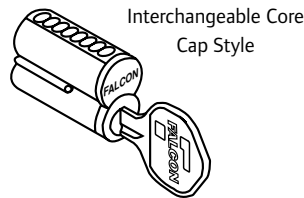
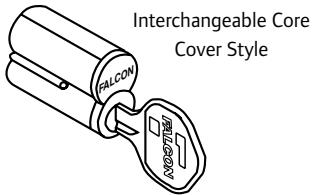

Falcon Standard Cylinders

Catalog Number	Description
A23155-02	5-pin* For use in all B-Series except B611*
A23155-06	5-pin For use in all B-Series except B611*
A23165-02	6-pin For use in all B-Series except B611*
A23165-06	6-pin For use in all B-Series except B611*

Note: Specify finish: 606 or 626.

Specify keyway: "E", "G" (standard), "H", "K", "L", "N", "P".

*B611 use same part number except -011, -11D and -11A

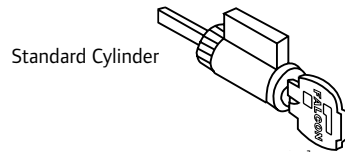

Standard Cylinders with Competitor Keyways-6-Pin

Catalog Number	Description
A23167-013	Corbin 60 'O' Bitted
A23167-13D	Corbin 60 'KD' Keyed Different
A23168-013	Russwin D1 'O' Bitted
A23168-13D	Russwin D1 'KD' Keyed Different
A23174-013	Corbin Russwin L4 'O' Bitted
A23174-13A	Corbin Russwin L4 'KA' Keyed Alike 4
A23166-013	Sargent LA 'O' Bitted
A23166-13D	Sargent LA 'KD' Keyed Different
A23160-013	Schlage C 'O' Bitted
A23160-13A	Schlage C 'KA' Keyed Alike 4
A23160-13D	Schlage C 'KD' Keyed Different
A23159-013	Schlage E 'O' Bitted
A23169-013	Yale 8 (PARA) 'O' Bitted
A23169-13D	Yale 8 (PARA) 'KD' Keyed Different

Note: Specify finish 606 or 626

For B611 use same part number except -011, -11A, -11D

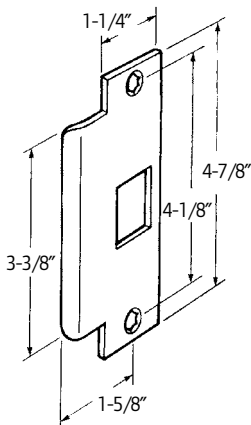

005164-000

ANSI Prep A115.2

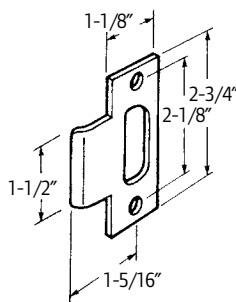

Q001-046

T-Strike Square **Corner**

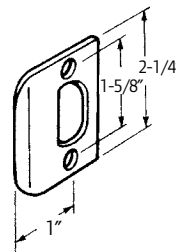

Q001-049

Full Lip, Square Corner

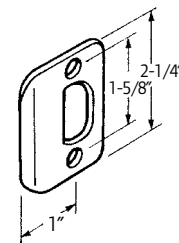

Q001-048

Full Lip, 1/4" Radius Corner

*Specify finish: 605, 606, 612, 613, 626 or 630.

FALCON B SERIES

OPTIONS AND ACCESSORIES (CONTINUED)

Latches—1/2" Projection, UL listed

Latches for B Series locks are UL listed.

2-3/4" backset standard.

2-3/8" optional.

Unless otherwise specified, we furnish a 2-1/4" x 1" x square corner faceplate on 2-3/8" backset latches and 2-1/4" x 1-1/8" x square corner on 2-3/4" backset latches.

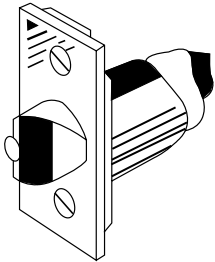

Square Corner
1/2" Projection

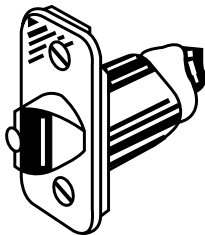

1/4" Radius Corner
1/2" Projection

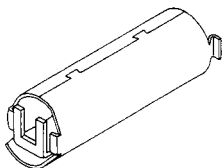

Long Backset Extension Link

A31727-005-00 link for 5" backset. For use with 2-3/8" backset latches.



1-1/2 Hour



Catalog Number	Description (functions)	Faceplate Size	Corner
A57420-000	2-3/8" Backset Spring (101)	2-1/4" x 1"	Square
A57420-00D	2-3/8" Backset Deadlocking	2-1/4" x 1"	Square
A57421-000	2-3/8" Backset Spring (101)	2-1/4" x 1"	Radius
A57421-00D	2-3/8" Backset Deadlocking	2-1/4" x 1"	Radius
A57425-000	2-3/8" Backset Spring (101)	2-1/4" x 1-1/8"	Square
A57425-00D	2-3/8" Backset Deadlocking	2-1/4" x 1-1/8"	Square
A57620-000	2-3/8" Backset Spring (301)	2-1/4" x 1"	Square
A57620-00D	2-3/8" Backset Deadlocking (611)	2-1/4" x 1"	Square
A57621-000	2-3/8" Backset Spring (301)	2-1/4" x 1"	Radius
A57621-00D	2-3/8" Backset Deadlocking (611)	2-1/4" x 1"	Radius
A57625-000	2-3/8" Backset Spring (301)	2-1/4" x 1-1/8"	Square
A57625-00D	2-3/8" Backset Deadlocking (611)	2-1/4" x 1-1/8"	Square
A57430-000	2-3/4" Backset Spring (101)	2-1/4" x 1"	Square
A57430-00D	2-3/4" Backset Deadlocking	2-1/4" x 1"	Square
A57431-000	2-3/4" Backset Spring (101)	2-1/4" x 1"	Radius
A57431-00D	2-3/4" Backset Deadlocking	2-1/4" x 1"	Radius
A57435-000	2-3/4" Backset Spring (101)	2-1/4" x 1-1/8"	Square
A57435-00D	2-3/4" Backset Deadlocking	2-1/4" x 1-1/8"	Square
A57630-000	2-3/4" Backset Spring (301)	2-1/4" x 1"	Square
A57630-00D	2-3/4" Backset Deadlocking (611)	2-1/4" x 1"	Square
A57631-000	2-3/4" Backset Spring (301)	2-1/4" x 1"	Radius
A57631-00D	2-3/4" Backset Deadlocking (611)	2-1/4" x 1"	Radius
A57635-000	2-3/4" Backset Spring (301)	2-1/4" x 1-1/8"	Square
A57635-00D	2-3/4" Backset Deadlocking (611)	2-1/4" x 1-1/8"	Square

Note: Specify finish: 605, 612, 613 or 630.

Construction Keying

Falcon offers two different construction key systems depending on the size of and application within the project. Both systems permit the installation and use of regular door locks during construction, yet completely preserve the security of the keying system for the ultimate building owner. The Master, Grand Master and change keys are never with the locks during the construction phase of a building. Only the “construction” keys are sent to the job site. Where the job permits, we will utilize the “Lost Pin System” as our standard system for construction keying. Larger or more complicated jobs may require the use of our “Blockokey® System” for construction keying.

“Disposable Construction” Interchangeable Cores

This newly designed disposable construction core (1408) is an inexpensive alternative to interior keyed construction cores. This core should be used on interior door applications or where security on a site is not a concern. No keys need to be issued. The disposable core is inserted in the lever or knob and is operated by a thumb turn, which retracts the latch bolt. Please use either brass or permanent construction cores on exterior doors or secured areas.

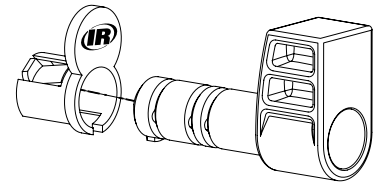

Locks with “Lost Pin System

Our “lost” pin construction key system consists of one construction pin and a shallow hole in the side of the plug.

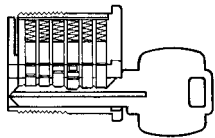

Construction Key—KB566

When the “construction” key is used, the construction pin is always in the cylinder plug, sitting on top of the bottom pin.

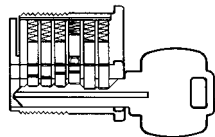

Master Key—KB578

When the Master key is inserted, the construction pin is pushed up into the cylinder housing. As the Master key is rotated to the right, the construction pin will drop into the hole in the plug, thereby eliminating any future use of the construction key.

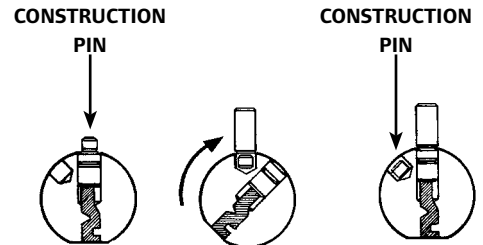

Locks with Blockokey® Cylinders

All lock cylinders on a specific project are operable by a special “project key.” Duplicates of this key may be assigned by the building contractor to workmen and subcontractors as required. No regular change keys or Master keys are needed on the job. This eliminates the possibility of subsequent exposure from lost or stolen keys.

How to order locks with Blockokey® Cylinders

Blockokey® locksets are ordered by adding the word “Blockokey” after the balance of the ordering information.

EXAMPLE: 72 Each B511 D 626 1AA-72AA (Blockokey)

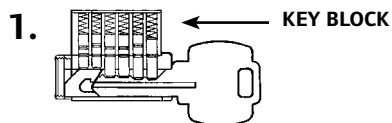

1. MProject Key—KB531

Lock cylinder is operated by the special “project key.” The last two pins in the cylinder are held inoperative by the key block.

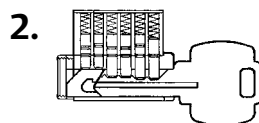

2. MProject Key—KB531

The special “project key” is canceled out by removal of the key block. A key block removal tool is furnished with the Master keys for the locks. Simply push the removal tool into the keyway, then withdraw it to remove the block. Thereafter, the “project key” will no longer operate the lock cylinder.

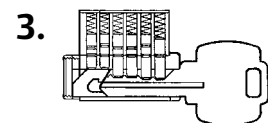

3. Change or Master Key—KB578

Cylinder is now only operable by the regular change key or Master key.

FALCON B SERIES CONVERSION CHART

B Series Grade 2 Cylindrical Key-In-Lever

ANSI Number/Grade	Function	Falcon	Arrow	Best	Corbin/Russwin	Marks	Sargent	Yale
F75-2	Passage	B101	M01	73KN	CL3910	N	65U15	5301LN
F76-2	Privacy	B301	M02	73KL	CL3920	L	65U65	5302LN
	Connecting/Exit	B341	—	—	CL3981	SB	—	—
F82-2	Entry	B501	M13	—	—	—	—	—
F109-2	Entry/Office	B511	M11	73KA	CL3951	AB	65G05	5307LN
F84-2	Classroom	B561	M17	73KR	CL3955	S	65G37	5308LN
F86-2	Storeroom	B581	M12	73KD	CL3957	F	65G04	5305LN
	Assisted Living	B611	—	—	CL3975	—	—	—
	Dummy—Single	B12	M08	1DT	CL3950	DO	65U93	—

Trim Styles

	Falcon	Arrow	Best	Corbin/Russwin	Marks	Sargent	Yale
	Dane	SR	15C	NZD	170/170R	KL	AU
	Quantum	BRR	—	PZD	270/270R	KP	PB

All effort has been made to make this information comprehensive. Since no two products are exactly alike, this data represents those products which are similar. This information was obtained from trade services and is not guaranteed nor meant to represent any product as equal to any other product.

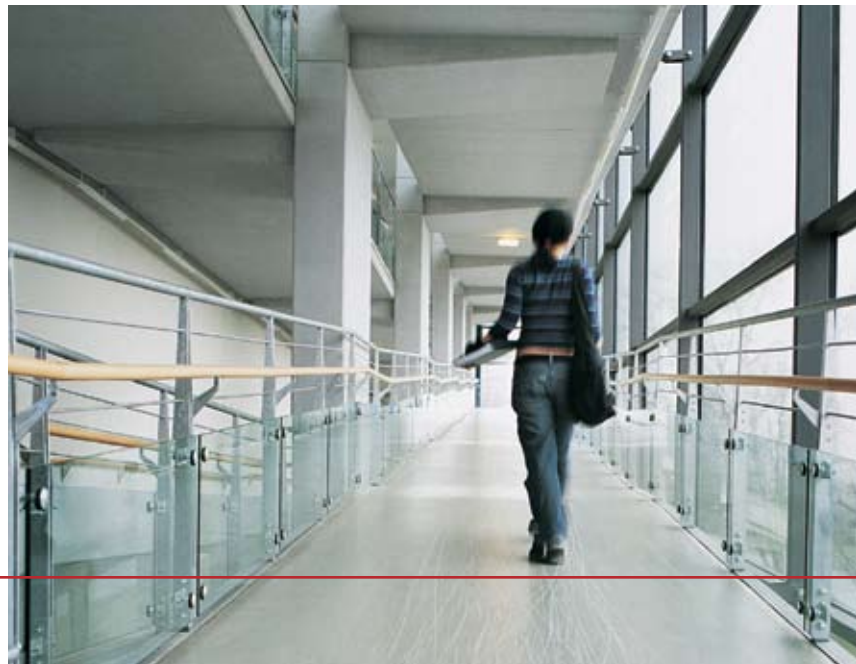

How to Order

For correct ordering, and to ensure no delays in shipment of your order, the following descriptive data must be listed in the sequence shown. Necessary information can be found in other parts of this catalog. The example below shows an order for 12 each B locksets in the 301 Privacy function, D (Dane) trim design in a 626 (satin chrome) finish, with 2-3/4" backset latch, to accommodate doors 1-3/4" thick.

Quantity: Indicate the quantity required.

Catalog Number: Select catalog number.

Trim Design: Indicate letter of lever design. D=Dane; Q=Quantum.

Finish: When the finish is the same for the outside and inside trim, it is shown once (626). For split finishes, the outside is designated first, then the inside (605 x 625).

Latches: 2-3/4" backset standard. 2-3/8" backset available. All latches are UL Listed 1-1/2 hour B Label.

Strikes: 4-7/8" x 1-1/4" ANSI strike standard. Optional T-Strike or Full Lip Strike available. See page 7.

Cylinder Type: For 6-pin, add 6-pin.

Keying Detail: We suggest using the standard terms developed by A.H.C. (Architectural Hardware Consultants). EXAMPLE: AA1-Grand Master keyed, Master keyed, change key 1.

Interchangeable Core: To order product capable of accepting an interchangeable core, add "FIC" (for interchangeable core). To order product with an interchangeable core, add "WIC" (with interchangeable core).

Keyways: "G" is standard on regular cylinders, "A" is standard on interchangeable cores. Other keyways available. See page 7.

Additional Keys: Note the total number of keys required. Large Bow Keys: Add-"with large bow keys."

How to Order Example

Qty.	Catalog Number	Trim Design	Finish	Latch	Strike	Cylinder	Detail
12	B301S	DAN	626	STD	STD	-	2-3/4" Backset- 1-3/4" Door

Finishes

The latest in modern techniques and equipment are used to apply the highest quality finish. Extra steps assure durable, consistent finishes and long useful life.

Although we apply the finest available protective plating and/or clear-coat powder coating to the surface of our products, these finishes have limitations and in time may deteriorate either from exposure to weather, pollution, perspiration, extremes of climate, frequency of use or other factors. Deterioration of these finishes is, therefore, not a defect, but a normal process which is unavoidable. Our company cannot accept responsibility for finish deterioration in these circumstances; therefore, the finishes cannot be guaranteed. These products will not be refinished or replaced under our warranty should deterioration of finishes occur.

Trim Finishes Chart

Description	ANSI Number	Available on
Bright Brass	605	All Trim
Satin Brass	606	All Trim
Satin Bronze	612	All Trim
Satin Bronze Oil Rubbed	613	All Trim
Bright Chrome	625	All Trim
Satin Chrome	626	All Trim



Ingersoll Rand's Security Technologies Sector is a leading global provider of products and services that make environments safe, secure and productive. The sector's market-leading products include electronic and biometric access-control systems; time-and-attendance and personnel scheduling systems; mechanical locks; portable security; door closers, exit devices, architectural hardware, and steel doors and frames; and other technologies and services for global security markets.

800-266-4456

www.falcon.ingersollrand.com

www.ingersollrand.com