



Product Specifications for E21302-10BZ

Job Name:	Job Type:
Quantity:	Comments:



E21302-10BZ
Inca 1-Light Wall Sconce

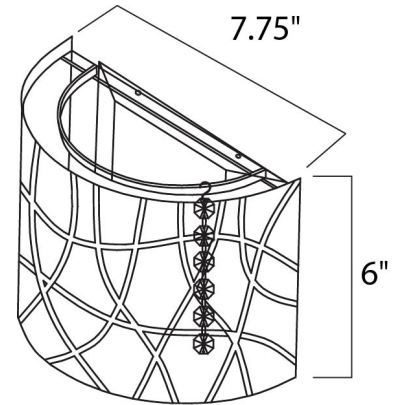

Finish
Bronze

Glass/Shade
Cognac

Product Category
Wall Sconce

Lamping

Number of Bulb(s)	1
Light Type	Xenon
Bulb Type	G9
Max Bulb Wattage	50
Max Fixture Wattage	50
Rated Life	±2,000 Hours
Rated Lumens	±800
Color Temp	±2,900 K
Bulb(s) Included	Yes
Light Up/Down	N/A
Beam Spread	N/A
CRI	N/A
Photo Cell Included	N/A
Ballast/Driver/Transformer	No
Dimmable	N/A

Measurements

Width	7.80"
Height	5.90"
Length	7.75"
Extension	4.00"
Back Plate Width	N/A
Back Plate Height	N/A
HCO	3.00"
Min Overall Height	N/A
Max Overall Height	N/A
Hanging Weight	1.54 lb(s)
Height Adjustable	N/A
Slope	N/A
Chain Length	N/A
Wire Length	N/A
Canopy Width	N/A
Canopy Height	N/A
Canopy Length	N/A

Shipping

Carton Weight	2.42 lb(s)
Carton Width	8.67"
Carton Height	7.09"
Carton Length	11.02"
Carton Cubic Feet	N/A
Master Pack	1
Master Pack Weight	N/A
Master Pack Width	N/A
Master Pack Height	N/A
Master Pack Length	N/A
Master Cubic Feet	N/A
UPS Shippable	Yes

Certification

Safety Rating	Dry
Energy Star	No
CA Title 24	No
CA Title 20	No
ADA	Yes

Other

UPC Code	845094060727
Material	Metal/Steel

Equivalents

Incandescent Watts	N/A
Fluorescent Watts	N/A

ET2 Contemporary Lighting and all designs, logos and images © 2015 ET2 Contemporary Lighting. All Rights Reserved. ET2 Contemporary Lighting reserves the right, at any time, to make changes in the design and/or construction of the product including the discontinuation of product without prior notice. Color may vary from what is pictured above due to limitations inherent to photographic processes. Always consult a qualified, licensed electrician before installation of any product weighing 35 pounds or more. We recommend that a qualified, licensed electrician do the installation. Always install to a mechanically sound structure.