

ET2 Contemporary Lighting

PRODUCT NAME: Inca
ITEM NUMBER: E21317-10BZ

Please consult your electrician for hanging fixture and wiring.

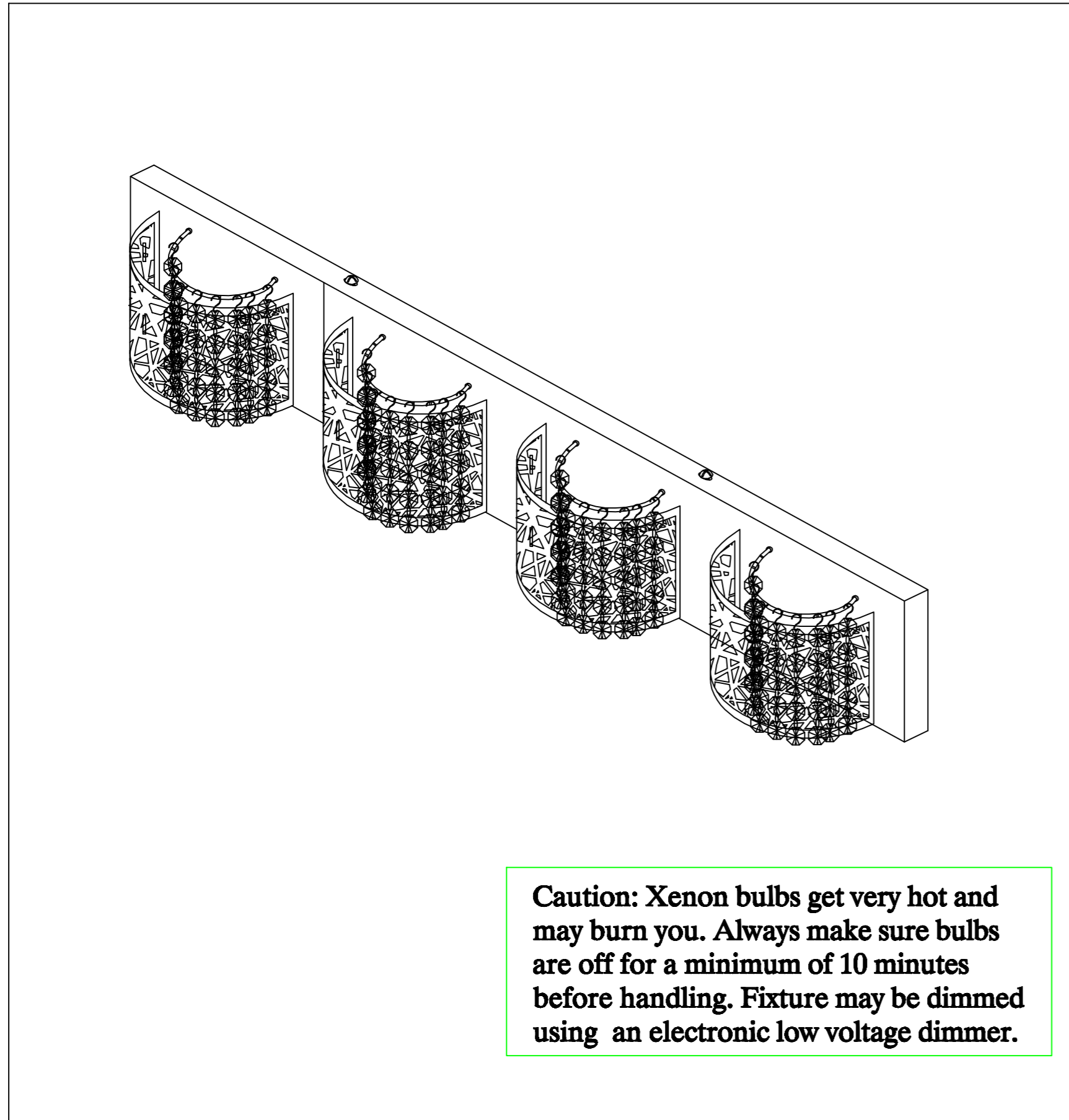

Caution: Xenon bulbs get very hot and may burn you. Always make sure bulbs are off for a minimum of 10 minutes before handling. Fixture may be dimmed using an electronic low voltage dimmer.

Bulbs (Included): G9X40W

IMPORTANT: Turn off the power at the main fuse or circuit breaker box before starting installation

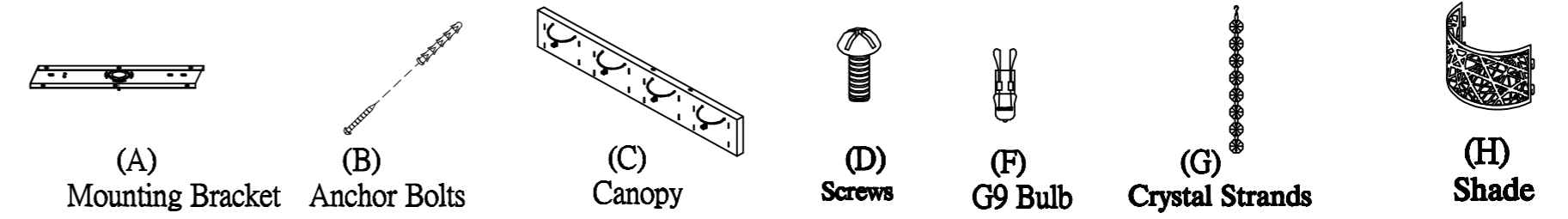

Locate all hardware & components before discarding packaging

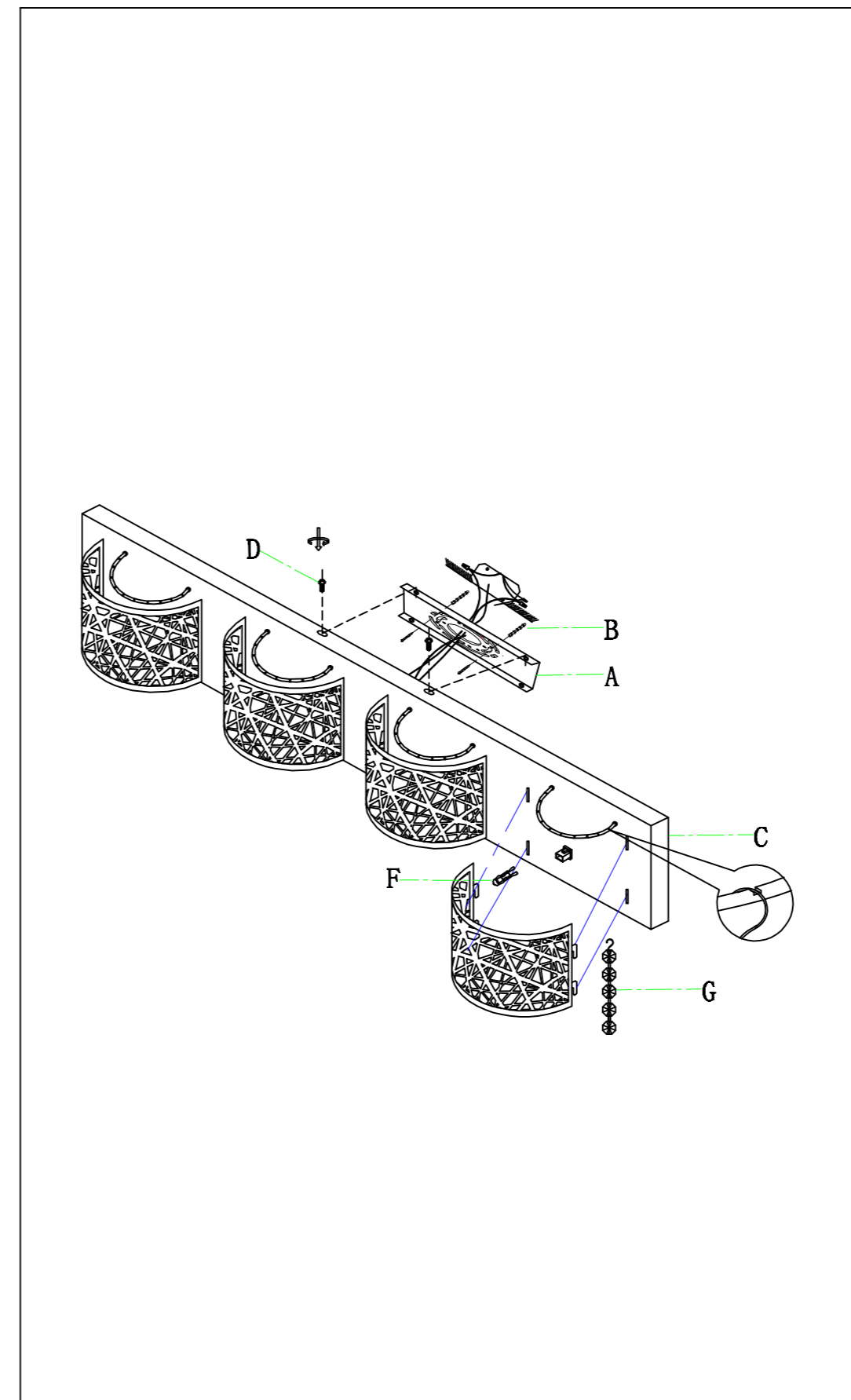

Cleaning & Care:
Clean with soft cloth and a mild detergent.
Do not use abrasive cleaner.

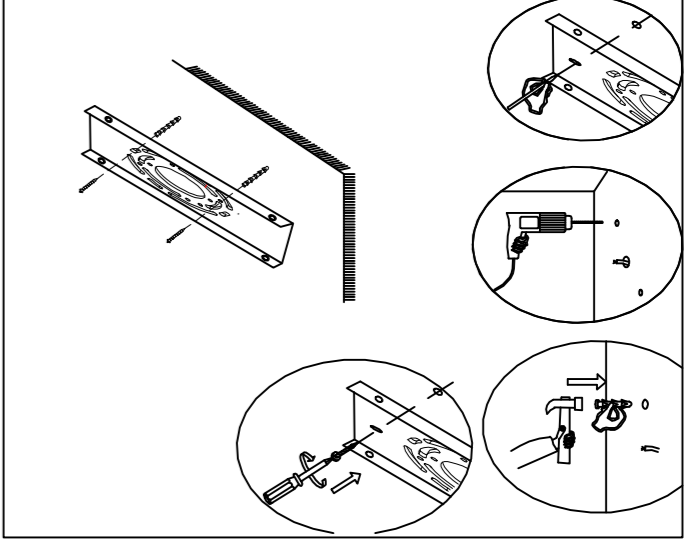
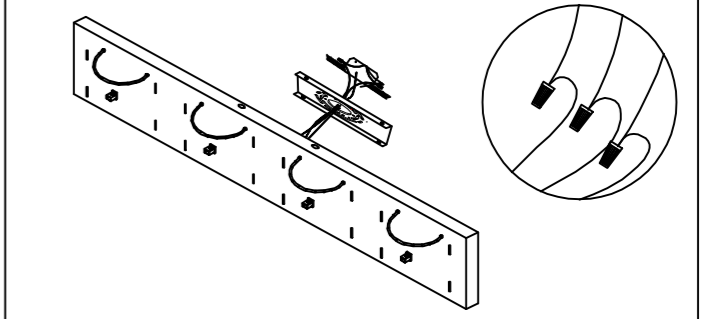
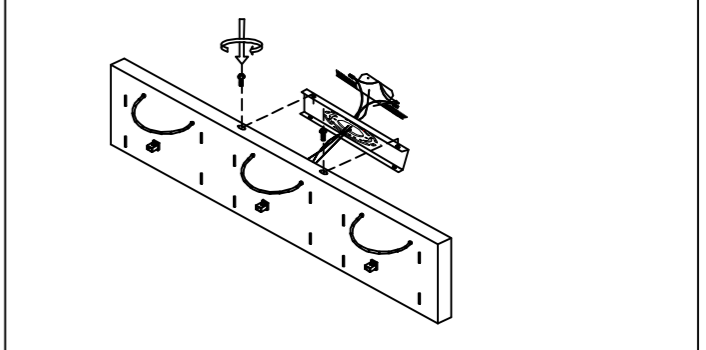
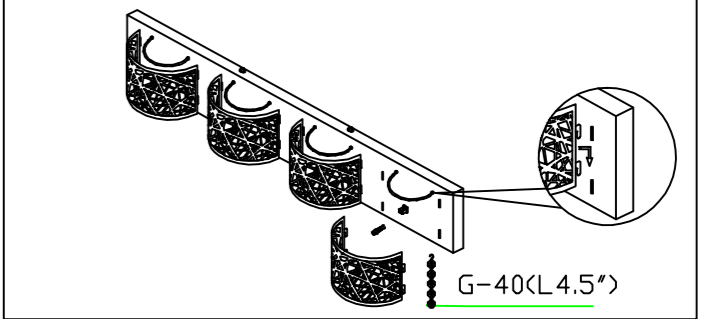
- 1.) 
Step.1: Remove mounting bracket (A) from Canopy (C) to install to electrical box
- 2.) 
Step.2: Wire fixture to wires in outlet box. Green wire is for Ground.
- 3.) 
Step.3: Secure fixture to mounting bracket using screws (D).
- 4.) 
Step.4: Slide shade (H) onto clips, install G9 bulbs (F) and hang crystal strands (G).