

Contemporary Lighting™

PRODUCT NAME: Half Moon 3LT Pendant
ITEM NUMBER: E20364

Please consult your electrician for hanging fixture and wiring.

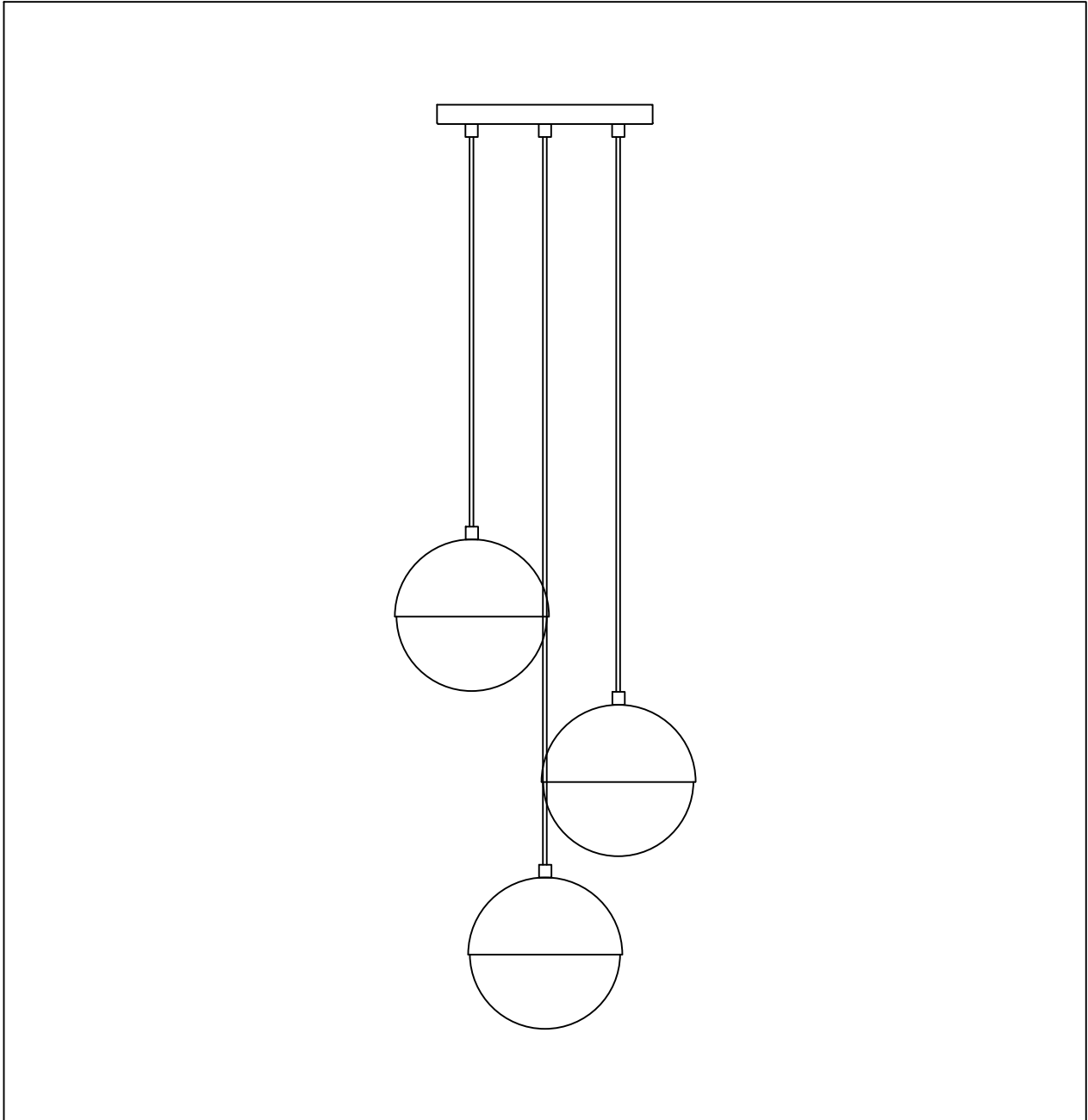

Bulbs (Included):3*E26*9W

IMPORTANT: Turn off the power at the main fuse or circuit breaker box before starting installation

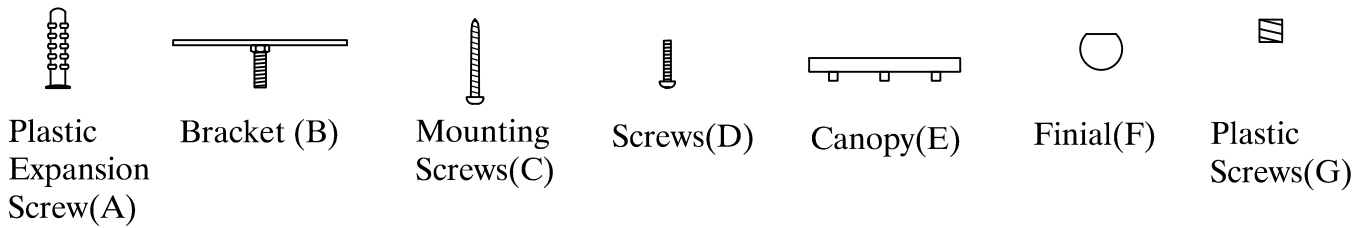

Locate all hardware & components before discarding packaging

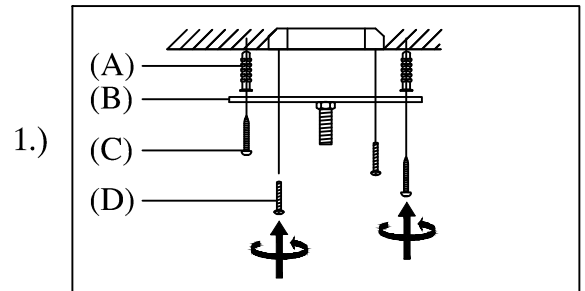
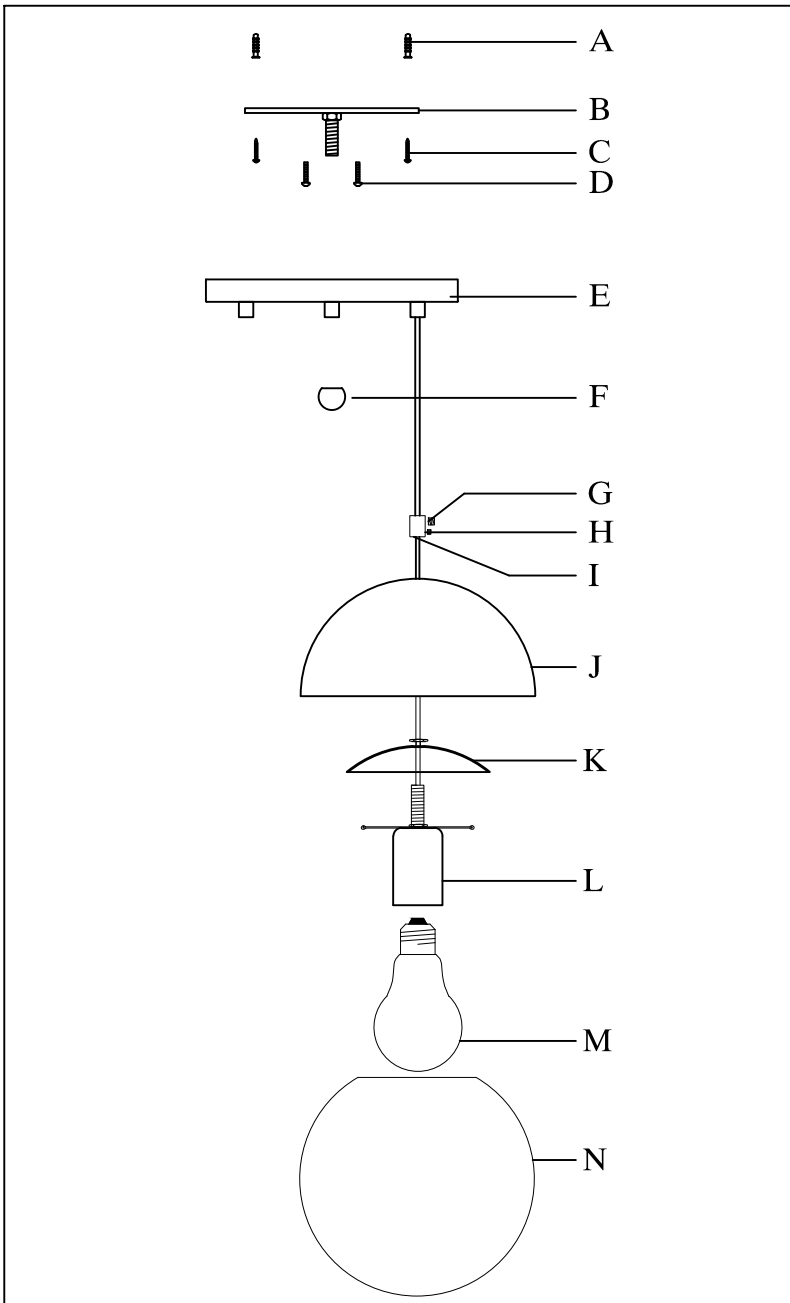

Step1 :Remove mounting bracket from fixture and install to electrical box.

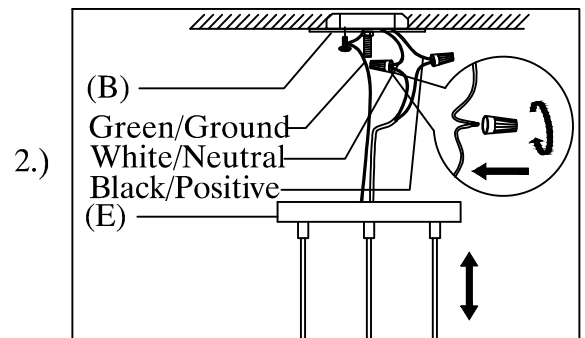

Step2 :Adjust wire length to desired mounting height, and tighten strain relief screws to secure. Wire fixture to wires in outlet box. Green wire is for Ground.

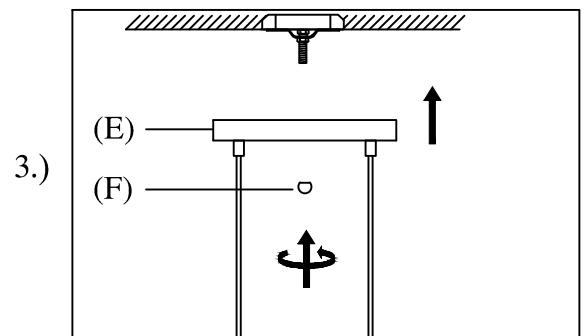

Step 3: Install fixture to bracket using finial (F) to secure.

Cleaning & Care:
Clean with soft cloth and a mild detergent.
Do not use abrasive cleaner.

IMPORTANT: Turn off the power at the main fuse or circuit breaker box before starting installation

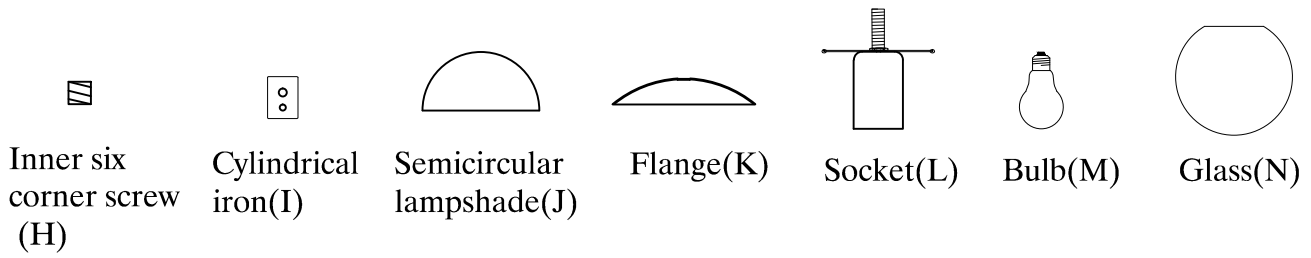

Replace glass and light bulbs - take down

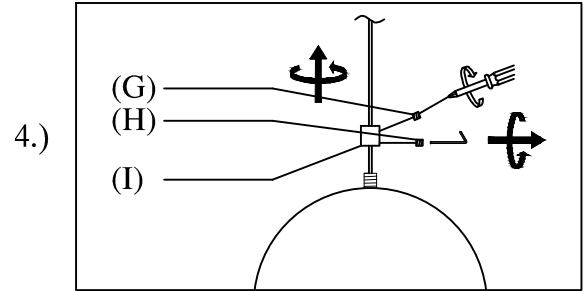
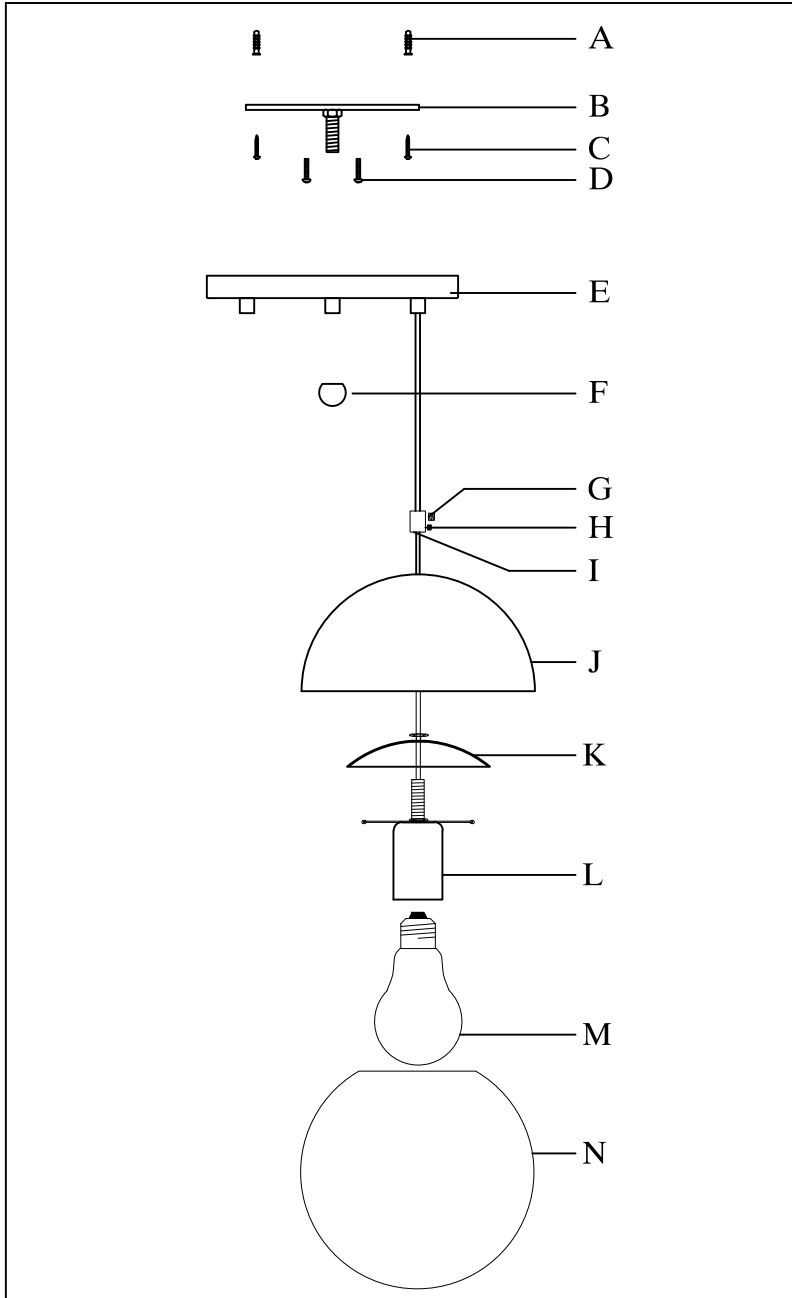

Step4 :Twist the plastic screws(G) with a screwdriver, use the six angle wrench to loosen the inner six corner screws(H), and twist the cylindrical iron(I) parts.

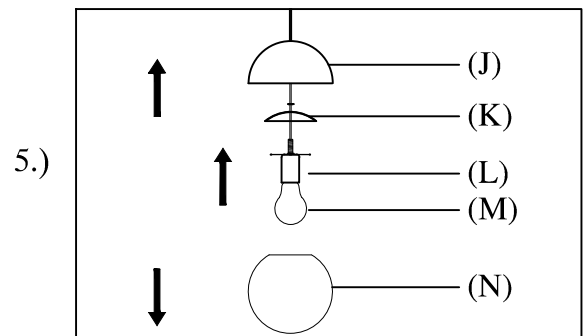

Step5 :Open the semicircle lampshade(J), twist the nut and take out the Flange(K) and the lamp socket(L) and Glass(N).

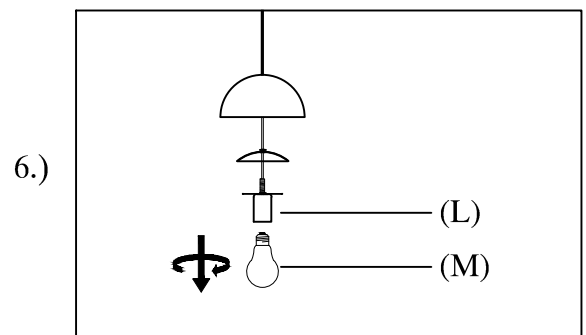

Step6 :Turn the bulb out of the socket.

Cleaning & Care:
Clean with soft cloth and a mild detergent.
Do not use abrasive cleaner.

IMPORTANT: Turn off the power at the main fuse or circuit breaker box before starting installation

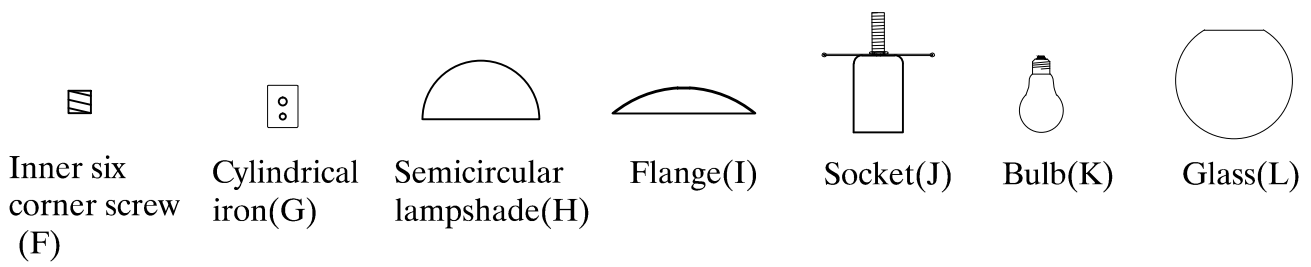

Replace glass and light bulbs - install

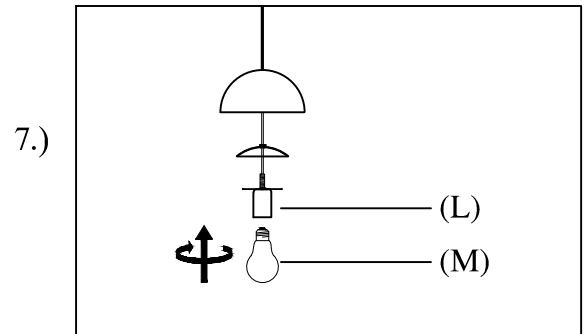
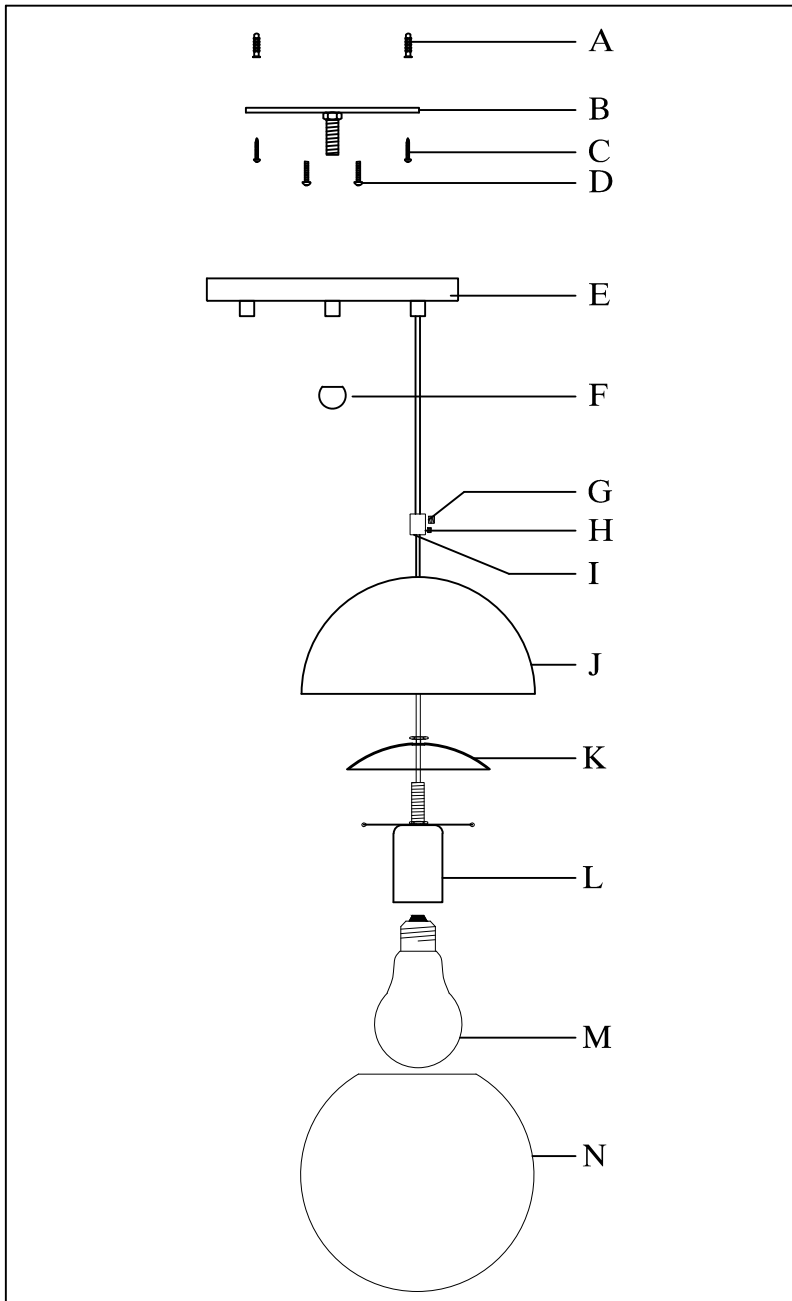

Step7 :Twist the new bulb(M) into the lamp socket(L).

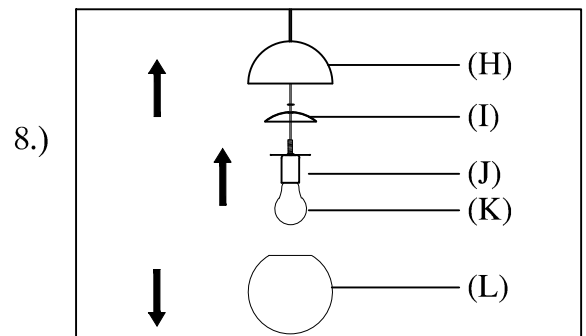

Step8 :Tilt the lamp socket(J) into the Glass(L). Place the Glass(L) flat, cover the Flange(I),tighten the nut and cover the upper Semicircular lampshade(H).

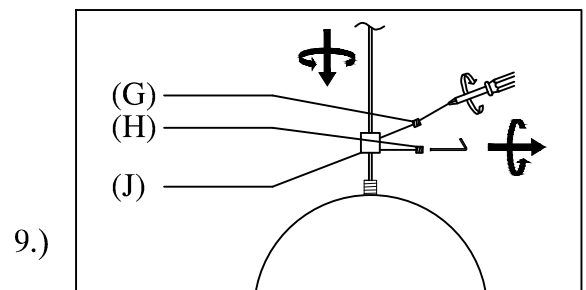

Step9 :To tighten cylindrical iron(J) parts, first lock the inner hexagonal screw(H) with an inner hexagonal wrench, and then lock the plastic screw(G) with a screwdriver.

Cleaning & Care:
Clean with soft cloth and a mild detergent.
Do not use abrasive cleaner.