



Contemporary
Lighting™

PRODUCT NAME : Moonbeam LED

ITEM NUMBER: E22444-11MS

Please consult your electrician for hanging fixture and wiring.

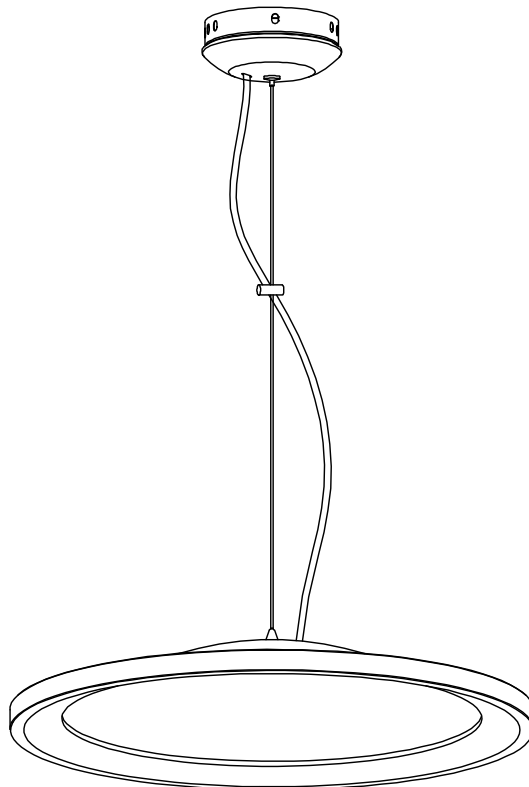

WARNING: WIRES NEED TO BE CONNECTED TO DRIVER FOUND IN CANOPY AND SHOULD NOT CONECT DIRECTLY TO POWER SOURCE OR A SHORT MIGHT OCCUR.

The fixture is designed to dim with a standard Triac forward phase dimmer. Dimming levels will vary by dimmer.

Below is a list of recommended dimmers:

Lutron MACL-153M
Lutron DVL-153P
Lutron SCL-153P
Leviton IPL06-10Z
Leviton 6674-POW

Due to the inrush current wattage should not exceed 150 watts of product for a 600 watt dimmer.

20W LED

PRODUCTS ARE NOT INENDED FOR COMMERCIAL USE.

MADE IN CHINA

Page 1 of (2)

IMPORTANT: Turn off the power at the main fuse or circuit breaker box before starting installation



Bracket (A)

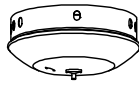

Canopy (B)

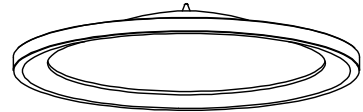

Body (C)

Locate all hardware & components before discarding packaging

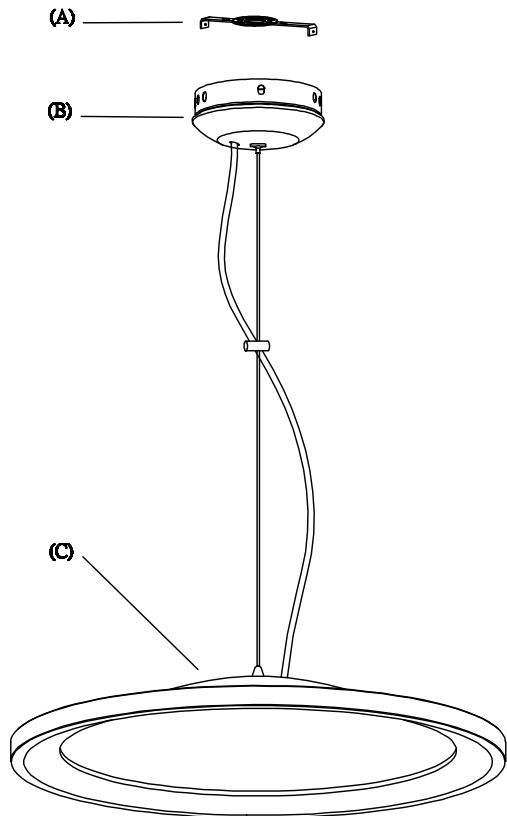

1.)

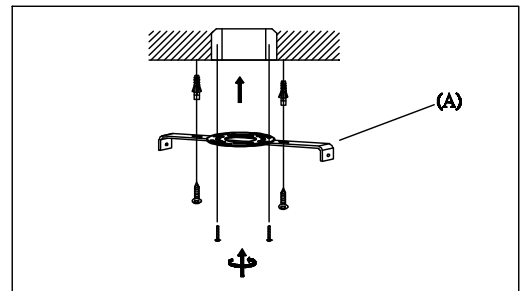

Step 1: Remove Bracket (A) from fixture and install to electrical box.

2.)

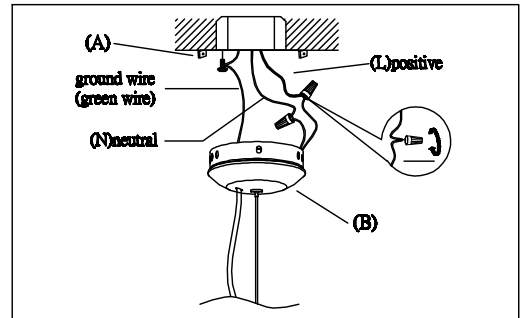

Step 2: Wire fixture to wires in outlet box. Install Green wire to Ground Screw.

3.)

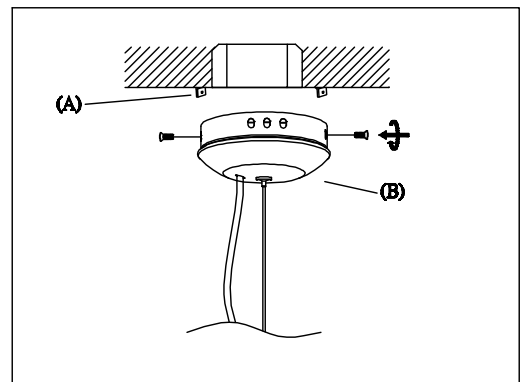

Step 3: Adjust wire length to desired hanging height. Install Canopy (B) to Bracket (A) and tighten screws at the ends of canopy to secure.

Cleaning & Care:

Clean with soft cloth and a mild detergent.
Do not use abrasive cleaner.