

# Instructions

25-51141-CH – Chrome  
25-51141-SS – Stainless Steel



## Certifications



## Single Handle, Pull-Down, Kitchen Faucet

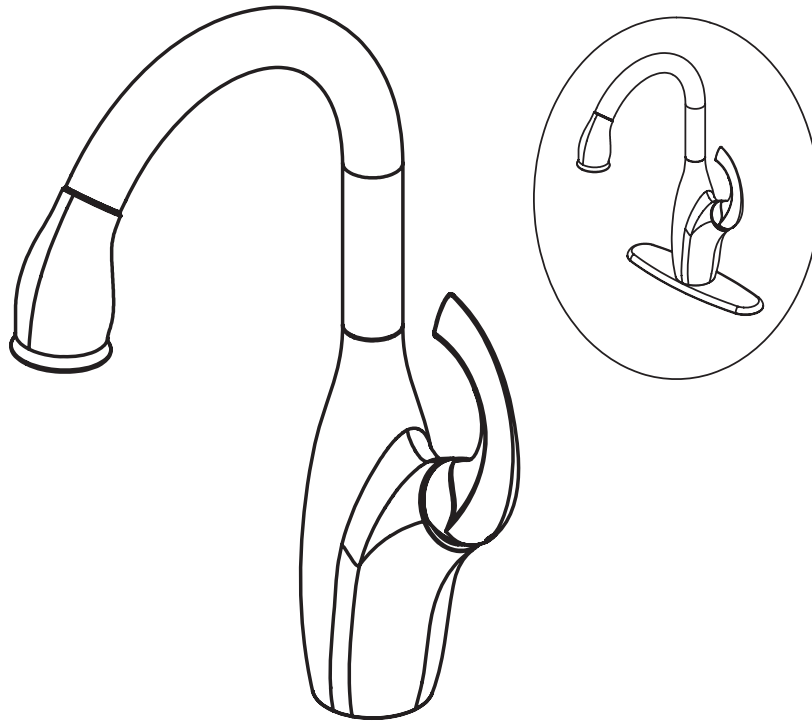

\*Image may vary slightly from actual product

### Tools Required

Adjustable Wrench  
Groove Joint Pliers  
Pipe Wrench  
Phillips Screwdriver  
Pipe Tape or pipe thread compound



### Safety Tips

If you solder the joints during installation of the faucet, the seats, cartridges, and washers must be removed before using a flame or the warranty will be voided on these parts.

Protect your eyes with safety glasses when cutting or soldering water supply lines.

Cover the sink drain to avoid losing parts.

### Things You May Need

Installations may vary depending on how the previous faucet was installed. Supplies necessary for the installation of your faucet are not all included; however, they are available wherever plumbing supplies are sold.

### Maintenance

Your new kitchen faucet is designed for years of trouble-free performance.

Keep it looking new by cleaning it periodically with a soft cloth. Avoid abrasive cleaners, steel wool, and harsh chemicals as these will dull the finish and void your warranty.

### Important Points

Prior to beginning installation, turn off the hot and cold water lines, then turn on the old faucet to release built-up pressure. When installing your new faucet, turn the connector nuts finger tight, then use one wrench to hold the fitting and a second wrench to tighten the nut. Connections that are too tight will reduce the integrity of the system.

Wrap all threaded connections with PTFE pipe tape available at your local hardware or plumbing supply store. Always wrap in a clock-wise direction.

### Contact Us

For Customer Service please call 877-319-3757, or go to [homeworksww.com](http://homeworksww.com).

# Instructions

25-51141-CH – Chrome  
25-51141-SS – Stainless Steel



## Certifications



### Single Handle, Pull-Down, Kitchen Faucet

#### Preparation and Assembly

1

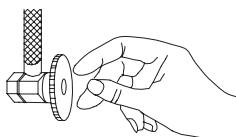

Locate water supply inlet and shut off water supply valve. These are usually found under the sink or near the water heater. Remove old faucet. Clean and dry sink surface area where new faucet will be mounted.

2

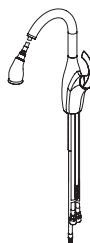

**ATTACH SPOUT TO VALVE**  
Feed hose assembly through spout and hub. Attach sprayer to end of hose to keep hose in place. Rotate spout assembly to ensure smooth operation.

3

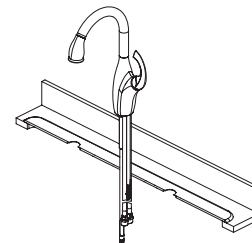

**MOUNT FAUCET TO DECK**  
Insert faucet through mounting holes in sink. Your faucet is designed for a hole diameter of  $1\text{-}3/8" \pm 1/4"$  ( $35\text{mm} \pm 6\text{mm}$ ) and a deck thickness of up to  $2\text{-}1/2"$  ( $64\text{mm}$ ).

4

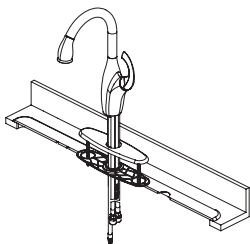

**OPTIONAL ESCUTCHEON INSTALLATION**  
Screw metal threaded rods upwards into cover plate and base plate on the sink. Insert faucet through mounting holes in sink.

5

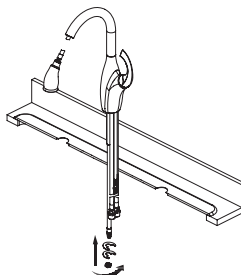

Install rubber washer, metal washer and nut onto the mounting shank.

6

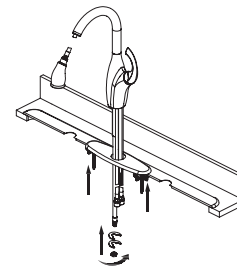

Hand tighten mounting nut onto bolt. Install rubber washer, metal washer and nut onto the mounting shank.

7

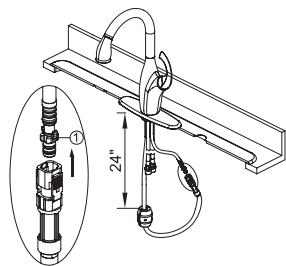

**HOSE INSTALLATION**  
Align block (1) onto hose. Install quick connect onto spray hose. Push quick connect firmly onto outlet hose tab. Install weights onto spray hose. Locate the weights 24" from the underside of the sink deck.

8

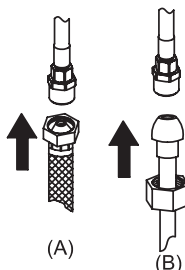

Connect water supply lines.  
(A) Use  $1/2"$  IPS faucet supply lines or use coupling nuts (not supplied) with ball-nose risers (not included).  
Turn water supply or shut-off valve back on and check for leaks. If leaks occur, gently tighten the faucet connections.

9

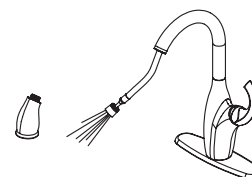

**FAUCET OPERATION AND INSPECTION**  
Turn on hot and cold water supplies. Pull the hose assembly out of the spout and remove the spray head. Be sure to hold the end of the hose down into the sink and turn faucet handle to the mixed position. Flush water lines for one minute. Check for leaks. Re-tighten if necessary, but do not overtighten. Reinstall the spray head.

# Troubleshooting

25-51141-CH – Chrome

25-51141-SS – Stainless Steel



## Certifications



### Single Handle, Pull-Down, Kitchen Faucet

#### Troubleshooting

**PROBLEM:** Leaks underneath handle and water does not completely shut off

**CAUSE:** Bonnet has come loose or O-ring on cartridge is dirty or worn.

**ACTION:**

1. Remove handle by loosening the set screw with a Phillips screwdriver and unscrew cap (Diagram A).
2. Tighten the bonnet nut by turning it clockwise (Diagram B). Move the cartridge stem to the on position. The leak should stop draining out from around the cartridge stem.

3. If the leak does not stop, shut off the water supply. Remove the bonnet nut by turning it counter-clockwise. Lift out the cartridge (Diagram C). Clear or replace the cartridge by call Customer Service.
5. Re-install the handle.

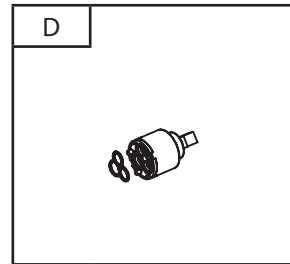
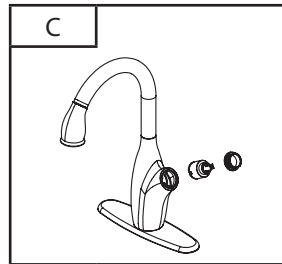
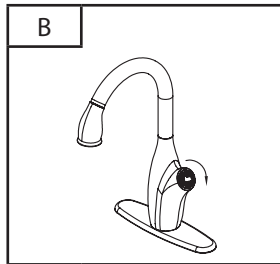
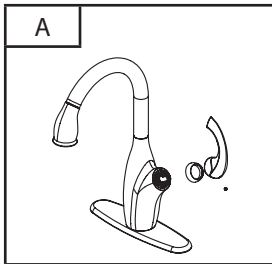

# Specifications



## Physical Characteristics

- Description: Single handle kitchen faucet with 8" center distance, pull-down 2-setting spray, ceramic cartridge, nylon hose and optional deck plate
- 1 or 3-hole installation
- Max. Flow Rate: 2.2 GPM (8.3 LPM)
- Meets ASME A112.18.1/CSA B125 requirements
- Meets ANSI/NSF 61-9 low lead requirements
- This product complies with 0.25% weighted average lead content on wetted surfaces.
- Total Weight of Item: 6.519 lbs.

## Certifications



25-51141-CH – Chrome  
25-51141-SS – Stainless Steel

No.	Part Description	Material
1	Spray head	Plastic
2	Inverter	POM M90
3	Spout	Brass C27000
4	Wearable washer	POM M90
5	Spout nut	Brass C27000
6	Body	Zinc ZZnA14
7	Washer	EVA
8	Cartridge seat	Brass C27000
9	Cartridge	CERAMIC+POM+S.S 304 +PA6+SILICONE+PPO
10	Bonnet	Brass C27000
11	Cap	ABS PA272
12	Set screw	SUS302/304
13	Handle	Zinc ZZnA14
14	Escutcheon	Zinc ZZnA14
15	Bolt	Steel Q235A
16	Base plate	PP+CaCO3
17	Mounting nut	ABS PA727
18	Shank	Brass C27000
19	Washer	NBR N7008F
20	Metal washer	Steel Q235A
21	Nut	Steel Q235A
22	Weights	Steel HT150+Q235A
23	O-ring	MAIHUA N7012F
24	Hose assembly	Brass C37700+S.S 304+TPE+EPDM E7008F
25	Connection clip	POM M90
26	O-ring	NBR N7008F
27	Hose assembly	Brass +S.S. +Plastic +NBR
28	Coupling nut	Brass C27000
29	Hose assembly	-
29A	Wearable washer	Delrin 500P NC010
29B	Connector	Brass C27000
29J	Hose	Brass C37700+Nylon+S.S302
29C	Washer	EPDM
29D	Washer	POM
29E	Washer	EPDM
29F	O-ring	EPDM E7008F
29G	Quick connector	Celcon M90
29H	Clip	POM
29I	Air valve	POM+S.S+NBR

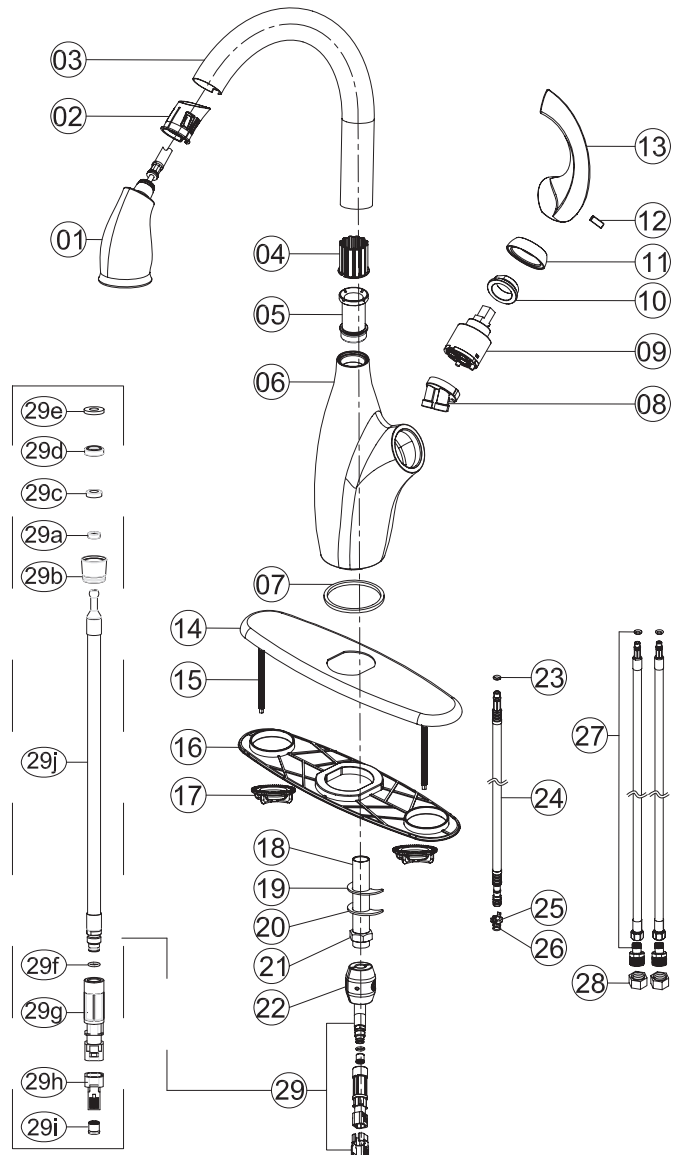

# Rough-In

25-51141-CH – Chrome  
 25-51141-SS – Stainless Steel



## Certifications



### Single Handle, Pull-Down, Kitchen Faucet

