

PRODUCT SPECIFICATIONS

Gourmet (Lustertone®) Stainless Steel Double Bowl Undermount Sink. Overall dimensions are 31-1/4" x 20-1/2" x 4-3/8". Sink is manufactured from 18 gauge 304 Stainless Steel with a Lustrous Highlighted Satin finish, Rear Center drain placement and Full spray sides and bottom.

Installation Type:	Undermount
Material:	304 Stainless Steel
Finish:	Lustrous Highlighted Satin
Gauge:	18
Sound Deadening:	Full spray sides and bottom
Number of Bowls:	2
Sink Dimensions:	31-1/4" x 20-1/2" x 4-3/8"
Bowl 1 Dimensions:	14" x 18" x 4-3/8"
Bowl 2 Dimensions:	13-1/2" x 16" x 4-3/8"
Drain Size:	3-1/2" (89mm)
Drain Location:	Rear Center
Minimum Cabinet Size:	36"
Mounting Hardware:	Undermount brackets sold separately
Template Included:	Yes
Cutout Template #:	1000001389

Template is available for download at [elkay.com](#)



This sink is compliant to ADA and ANSI/ICC A117.1 accessibility requirements when installed according to the requirements outlined in these standards.

Installation Profile:

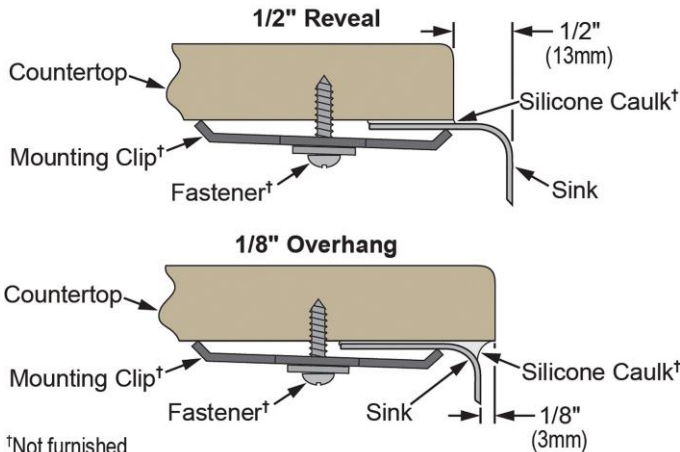

†Not furnished
Designed to affix to the underside of any solid surface countertop.

PART: _____ QTY: _____
 PROJECT: _____
 CONTACT: _____
 DATE: _____
 NOTES: _____
 APPROVAL: _____



AMERICAN PRIDE. A LIFETIME TRADITION.
Like your family, the Elkay family has values and traditions that endure. For almost a century, Elkay has been a family-owned and operated company, providing thousands of jobs that support our families and communities.



Sinks are listed by IAPMO® as meeting the applicable requirements of the Uniform Plumbing Code®, International Plumbing Code®, and National Plumbing Code of Canada.

Product Compliance: ADA
BUY AMERICAN ACT
ASME A112.19.3/CSA B45.4

[Clean and Care Manual \(PDF\)](#)
[Installation Instructions \(PDF\)](#)
[Limited Lifetime Warranty \(PDF\)](#)

Similar models are available with: additional ADA depths, Perfect Drain, small bowl on the opposite side

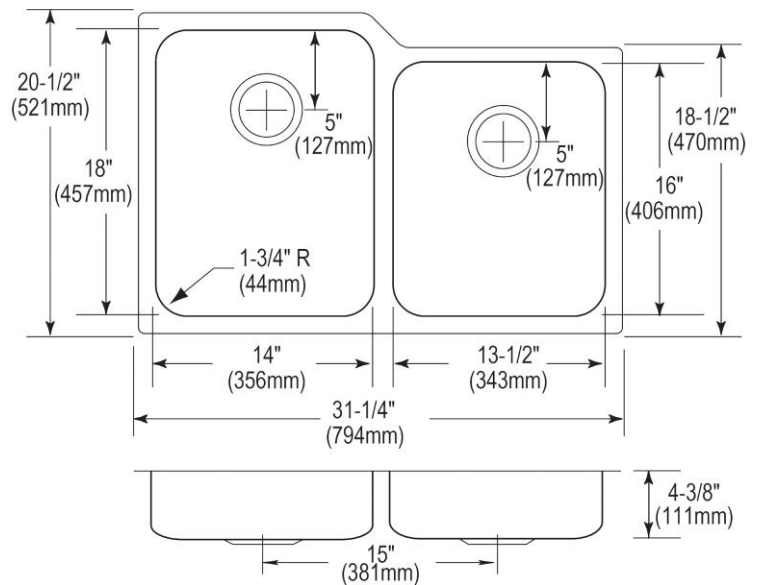

In keeping with our policy of continuing product improvement, Elkay reserves the right to change product specifications without notice. Please visit [elkay.com](#) for the most current version of Elkay product specification sheets. This specification describes an Elkay product with design, quality, and functional benefits to the user. When making a comparison of other producers' offerings, be certain these features are not overlooked.

OPTIONAL ACCESSORIES

Bottom Grid:	LKWOBG1418SS (large bowl), LKWOBG1316SS (small bowl)
Cutting Board:	CBR1418*, CBS1418*, CB1613*, CB1713*, CBR1316*, CBS1316*
Drain:	LK99, LKAD35
Faucet:	LKGT1041, LKGT2041
Hardware:	LKUCLIP8 (2 Required)
Rinsing Basket:	LKWRB1418SS, LKWERBSS, LKWRB1316SS
Sinkmate:	LKSM17, LKSMHOOK, LKSMSPONGE, LKSMHSL
Soap Dispenser:	LKGT1054
* 1/2" sink reveal required for proper fit.	

In keeping with our policy of continuing product improvement, Elkay reserves the right to change product specifications without notice. Please visit elkay.com for the most current version of Elkay product specification sheets. This specification describes an Elkay product with design, quality, and functional benefits to the user. When making a comparison of other producers' offerings, be certain these features are not overlooked.