

ELKAY® SPECIFICATIONS

Gourmet® Single Bowl Sink Featuring E-Granite, Undermount Models ELGU2522 Series

GENERAL

Molded from Elkay E-Granite which is up to 85% natural quartz and high performance acrylic resins. E-Granite is non-porous and resists staining. E-Granite is hard enough to resist scratches and chips, is naturally sound deadened, and heat resistant. The color is solid throughout the sink and is UV resistant to prevent color-fading in indoor applications. Undermount.

DESIGN FEATURES

Bowl Depth: 9-1/2" (241mm).

Material: Elkay E-Granite.

Color Options with natural accents: Black (BK), Bisque (BQ), Mocha (MC) or White (WH).

OTHER

Drain Opening: 3-1/2" (89mm).

Note: All Elkay undermount sinks are designed to affix to the underside of any solid surface countertop.

These sinks comply with ANSI Z124.6 and CSA B45-02.

 These sinks are listed by the International Association of Plumbing and Mechanical Officials as meeting the requirements of the Uniform Plumbing Code and the National Plumbing Code of Canada.

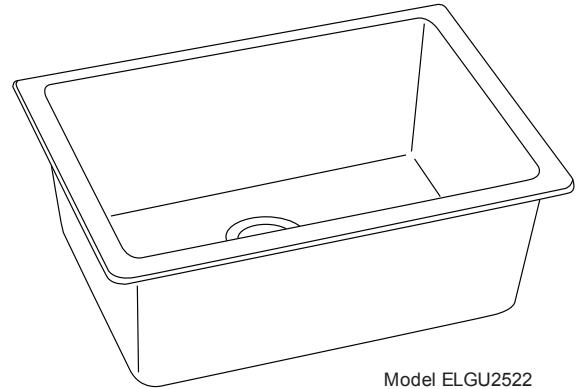

Model ELGU2522

SINK DIMENSIONS*

Model Number	Overall		Inside Bowl			Minimum Cabinet Size
	L	W	L	W	D	
ELGU2522BK	25 (635mm)	18 1/2 (470mm)	22 3/8 (568mm)	16 3/8 (416mm)	9 1/2 (241mm)	30 (762mm)
ELGU2522BQ	25 (635mm)	18 1/2 (470mm)	22 3/8 (568mm)	16 3/8 (416mm)	9 1/2 (241mm)	30 (762mm)
ELGU2522MC	25 (635mm)	18 1/2 (470mm)	22 3/8 (568mm)	16 3/8 (416mm)	9 1/2 (241mm)	30 (762mm)
ELGU2522WH	25 (635mm)	18 1/2 (470mm)	22 3/8 (568mm)	16 3/8 (416mm)	9 1/2 (241mm)	30 (762mm)

*Length is left to right. Width is front to back.
Template and countertop mounting clips are packed with every sink.

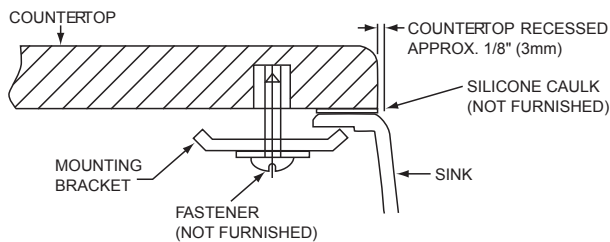
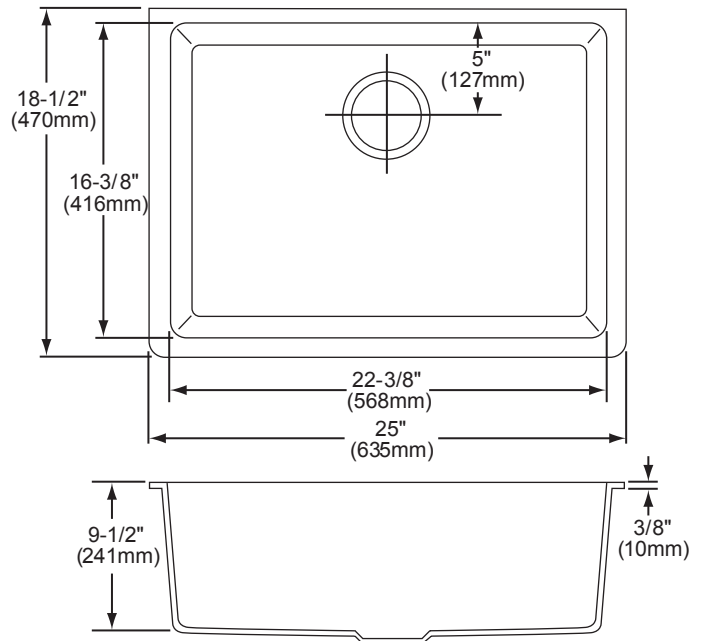

In keeping with our policy of continuing product improvement, Elkay reserves the right to change product specifications without notice. Please visit elkayusa.com for most current version of Elkay product specification sheets.

This specification describes an Elkay product with design, quality and functional benefits to the user. When making a comparison of other producers' offerings, be certain these features are not overlooked.

Elkay

elkayusa.com

2222 Camden Court
Oak Brook, IL 60523

Printed in U.S.A.
©2009 Elkay

(Rev. 05/09) 1-288B

ELKAY® SPECIFICATIONS

Gourmet® Single Bowl Sink Featuring E-Granite, Undermount Models ELGU2522 Series

OPTIONAL ACCESSORIES

Drains: LKKDT35, LKD35, LKS35

Utensil Caddy for Rinsing Basket: LKWUCSS

For Additional Accessories see table below

Model Number	Description	Overall			Material/Finish
		L	W	Depth/Thickness	
LKCBEG2217HW	Cutting Board**	23-1/4" (591mm)	17-3/8" (441mm)	1" (25mm)	Hardwood
LKWOBG2217SS	Bottom Grid	19-3/4" (503mm)	13-3/4" (350mm)	1-1/8" (29mm)	Polished stainless steel
LKWRB2217SS	Rinsing Basket	19-3/4" (503mm)	13-3/4" (350mm)	5 3/8" (137mm)	Polished stainless steel

*Length is left to right. Width is front to back.

** Fits countertop opening

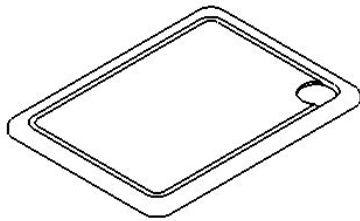

LKCBEG2217HW

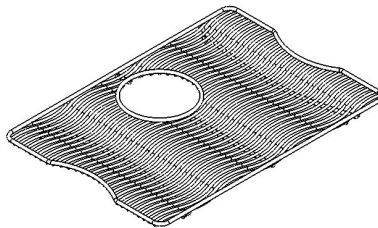

LKWOBG2217SS

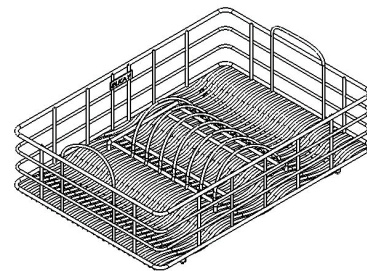

LKWRB2217SS

In keeping with our policy of continuing product improvement, Elkay reserves the right to change product specifications without notice. Please visit elkayusa.com for most current version of Elkay product specification sheets.

This specification describes an Elkay product with design, quality and functional benefits to the user. When making a comparison of other producers' offerings, be certain these features are not overlooked.

Elkay

elkayusa.com

2222 Camden Court
Oak Brook, IL 60523

Printed in U.S.A.
©2009 Elkay

(Rev. 05/09) 1-288B