

# ELKAY® SPECIFICATIONS

## Lustertone® Single Bowl Classroom Sinks and Sink Packages – Double Ledge Models DRKR and DRKRQ Series Models DRKAD and DRKADQ Series – A.D.A. Compliant

### GENERAL

Highest quality sink bowl seamlessly formed of #18 (1.2mm) gauge, type 304 (18-8) nickel bearing stainless steel. Top Mount.

### OTHER

DRKAD(Q)2517, DRKAD(Q)2220, DRKAD(Q)2522 and DRKAD(Q)3119 drain opening is 3-1/2" (89mm) and located centered left-to-right and off-center front-to-back as illustrated. All other drain opening sizes are 3-1/2" (89mm) and centered in bowl as illustrated.

Slotted hole allows for vandal-resistant faucet and bubbler.

Sink complies with ASME A112.19.3/ CSA B45.4

 Sinks are listed by IAPMO® as meeting the applicable requirements of the Uniform Plumbing Code®, International Plumbing Code®, and National Plumbing Code of Canada.

 Both the faucet and the bubbler are classified by Underwriters Laboratories Inc. to NSF/ANSI61 for residential use.

 All sinks 6-1/2" or less in depth are compliant to ADA and ANSI/ICC A117.1 accessibility requirements when installed according to the requirements outlined in these standards.

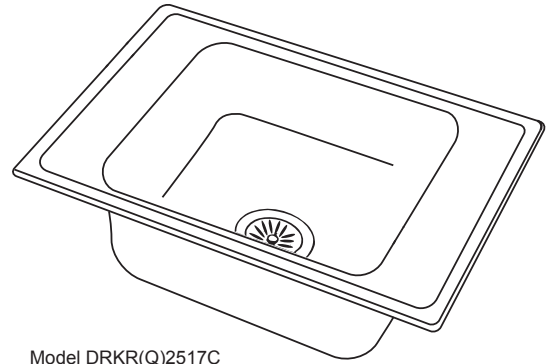

Model DRKR(Q)2517C



LKD2439C



LK1141A

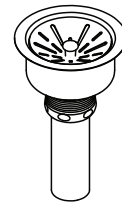

LK35

### U-Channel Type Mounting System

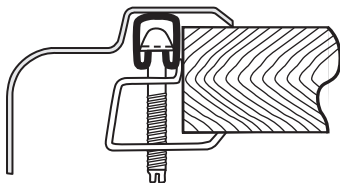

### Slotted Hole

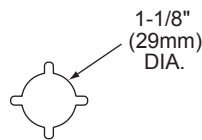

### Quick-Clip® Mounting system

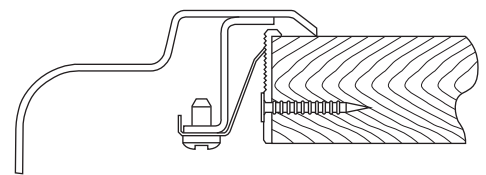

SEE NEXT PAGE FOR PRODUCT DIMENSIONS.

In keeping with our policy of continuing product improvement, Elkay reserves the right to change product specifications without notice. Please visit [elkay.com](http://elkay.com) for the most current version of Elkay product specification sheets.

This specification describes an Elkay product with design, quality, and functional benefits to the user. When making a comparison of others producers offerings, be certain these features are not overlooked.

**Lustertone® Single Bowl Classroom Sinks  
and Sink Packages – Double Ledge  
Models DRKR and DRKRQ Series  
Models DRKAD and DRKADQ Series – A.D.A. Compliant**

**ELKAY®  
SPECIFICATIONS**

**SINK DIMENSIONS\***

U-Channel Model Number	Quick-Clip® Model Number	Overall		Inside Bowl			Cutout in Counterop [1½"] (38mm) Radius Corners]		No. of Faucet Holes (see back page)	3½" (59mm) Drain Opening (see above for details)	Minimum Cabinet Size
		L	W	L	W	D	L	W			
		A	B	C	D	E	L	W			
DRKR2220C	DRKRQ2220C	22 (559mm)	19½ (495mm)	13½ (343mm)	16 (406mm)	7½ (191mm)	21¾ (543mm)	18¾ (479mm)	4	Centered	27 (686mm)
† DRKR2220	† DRKRQ2220	22 (559mm)	19½ (495mm)	13½ (343mm)	16 (406mm)	7½ (191mm)	21¾ (543mm)	18¾ (479mm)	2, 2LM, 4 FR2, 2FRM, FR4	Centered	27 (686mm)
DRKR2517C	DRKRQ2517C	25 (635mm)	17 (432mm)	16 (406mm)	13½ (343mm)	7¾ (194mm)	24¾ (619mm)	16¾ (416mm)	4	Centered	30 (762mm)
† DRKR2517	† DRKRQ2517	25 (635mm)	17 (432mm)	16 (406mm)	13½ (343mm)	7¾ (194mm)	24¾ (619mm)	16¾ (416mm)	2, 2LM, 4 FR2, 2FRM, FR4	Centered	30 (762mm)
† DRKR2522	† DRKRQ2522	25 (635mm)	22 (559mm)	16 (406mm)	19 (483mm)	7¾ (194mm)	24¾ (619mm)	21¾ (543mm)	2, 2LM, 4 FR2, 2FRM, FR4	Centered	30 (762mm)
DRKR3119C	DRKRQ3119C	31 (787mm)	19½ (495mm)	16 (406mm)	19 (483mm)	7¾ (194mm)	30¾ (772mm)	18¾ (479mm)	4	Centered	36 (914mm)
† DRKR3119	† DRKRQ3119	31 (787mm)	19½ (495mm)	22 (559mm)	16 (406mm)	7¾ (194mm)	30¾ (772mm)	18¾ (479mm)	2, 2LM, 4 FR2, 2FRM, FR4	Centered	36 (914mm)
DRKAD2220C	DRKADQ2220C	22 (559mm)	19½ (495mm)	13½ (343mm)	16 (406mm)	**	21¾ (543mm)	18¾ (479mm)	4	Off-Centered	27 (686mm)
† DRKAD2220	† DRKADQ2220	22 (559mm)	19½ (495mm)	13½ (343mm)	16 (406mm)	**	21¾ (543mm)	18¾ (479mm)	2, 2LM, 4 FR2, 2FRM, FR4	Off-Centered	27 (686mm)
DRKAD2517C	DRKADQ2517C	25 (635mm)	17 (432mm)	16 (406mm)	13½ (343mm)	**	24¾ (619mm)	16¾ (416mm)	4	Off-Centered	30 (762mm)
† DRKAD2517	† DRKADQ2517	25 (635mm)	17 (432mm)	16 (406mm)	13½ (343mm)	**	24¾ (619mm)	16¾ (416mm)	2, 2LM, 4 FR2, 2FRM, FR4	Off-Centered	30 (762mm)
† DRKAD2522	† DRKADQ2522	25 (635mm)	22 (559mm)	16 (406mm)	19 (483mm)	**	24¾ (619mm)	21¾ (543mm)	2, 2LM, 4 FR2, 2FRM, FR4	Off-Centered	30 (762mm)
DRKAD3119C	DRKADQ3119C	31 (787mm)	19½ (495mm)	22 (559mm)	16 (406mm)	**	30¾ (772mm)	18¾ (479mm)	4	Off-Centered	36 (914mm)
† DRKAD3119	† DRKADQ3119	31 (787mm)	19½ (495mm)	22 (559mm)	16 (406mm)	**	30¾ (772mm)	18¾ (479mm)	2, 2LM, 4 FR2, 2FRM, FR4	Off-Centered	36 (914mm)

\* Length is left to right. Width is front to back.

† Unless otherwise specified, all sinks which do not have suffix "C" are **less fittings** (no faucet, bubbler or drain), but are drilled for faucet, bubbler and drain as illustrated.

\*\* Available in 4" (102mm), 4-1/2" (114mm), 5" (127mm), 5-1/2" (140mm), 6" (152mm) or 6-1/2" (165mm) depths. Please consult your sales representative for other depths or modifications.

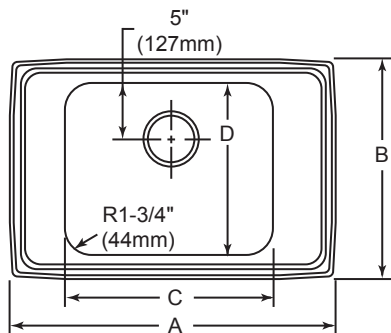

DRKAD(Q) Series  
Off-Centered Drain

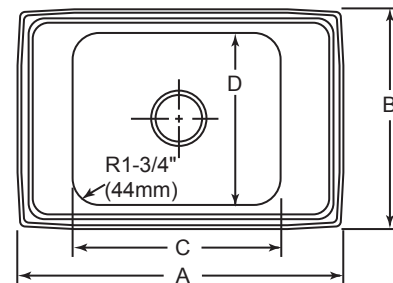

DRKR(Q) and DRKAD(Q) Series  
Centered Drain

### HOLE DRILLING CONFIGURATIONS

#### 2 HOLE CONFIGURATION

MODELS DRKAD(Q)2220\*\*2  
DRKAD(Q)2517\*\*2  
DRKAD(Q)2522\*\*2  
DRKAD(Q)3119\*\*2

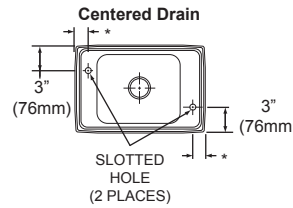
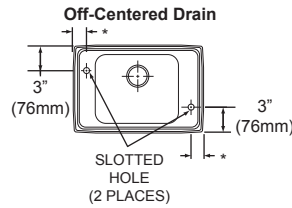

MODELS DRKR(Q)22202  
DRKR(Q)25172  
DRKR(Q)25222  
DRKR(Q)31192

#### FR2 HOLE CONFIGURATION

MODELS DRKAD(Q)2220\*\*FR2  
DRKAD(Q)2517\*\*FR2  
DRKAD(Q)2522\*\*FR2  
DRKAD(Q)3119\*\*FR2

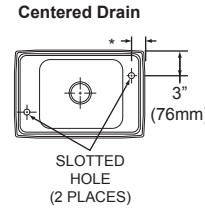
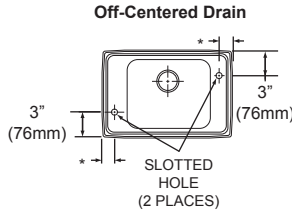

MODELS DRKR(Q)2220FR2  
DRKR(Q)2517FR2  
DRKR(Q)2522FR2  
DRKR(Q)3119FR2

#### 2LM (LEFT MIDDLE) HOLE CONFIGURATION

MODELS DRKAD(Q)2220\*\*2LM  
DRKAD(Q)2517\*\*2LM  
DRKAD(Q)2522\*\*2LM  
DRKAD(Q)3119\*\*2LM

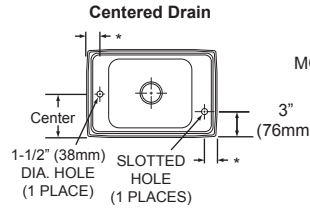
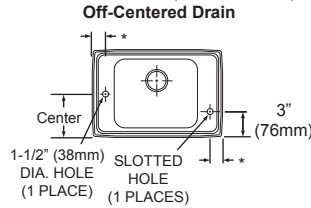

MODELS DRKR(Q)22202LM  
DRKR(Q)25172LM  
DRKR(Q)25222LM  
DRKR(Q)31192LM

#### 2FRM (RIGHT MIDDLE) HOLE CONFIGURATION

MODELS DRKAD(Q)2220\*\*2FRM  
DRKAD(Q)2517\*\*2FRM  
DRKAD(Q)2522\*\*2FRM  
DRKAD(Q)3119\*\*2FRM

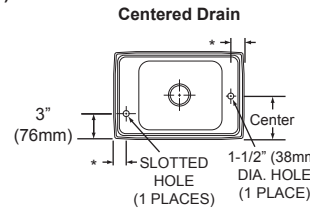
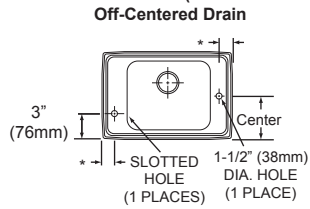

MODELS DRKR(Q)22202FRM  
DRKR(Q)25172FRM  
DRKR(Q)25222FRM  
DRKR(Q)31192FRM

#### 4 HOLE CONFIGURATION

MODELS DRKAD(Q)2220\*\*4  
DRKAD(Q)2517\*\*4  
DRKAD(Q)2522\*\*4  
DRKAD(Q)3119\*\*4

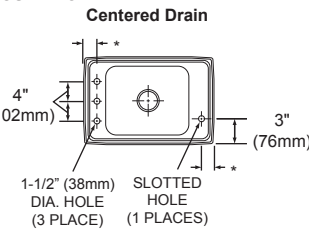
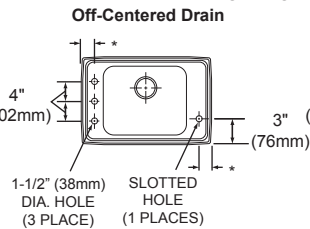

MODELS DRKR(Q)22204  
DRKR(Q)25174  
DRKR(Q)25224  
DRKR(Q)31194

#### FR4 HOLE CONFIGURATION

MODELS DRKAD(Q)2220\*\*FR4  
DRKAD(Q)2517\*\*FR4  
DRKAD(Q)2522\*\*FR4  
DRKAD(Q)3119\*\*FR4

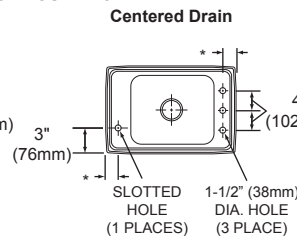
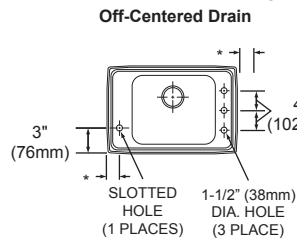

MODELS DRKR(Q)2220FR4  
DRKR(Q)2517FR4  
DRKR(Q)2522FR4  
DRKR(Q)3119FR4

\* 2-1/2" (64mm) for DRKR(Q)2522 and DRKAD(Q)2522, 2-1/4" (57mm) for all others.

\*\* Bowl depths for ADA models: 40 = 4" (102mm), 45 = 4-1/2" (114mm), 50 = 5" (127mm), 55 = 5-1/2" (140mm), 60 = 6" (152mm), 65 = 6-1/2" (165mm).