

ELKAY[®]

SPECIFICATIONS

Pacemaker[®] Single Bowl Hospitality Sink and Sink Packages

Models BPSRA150C, BPSH15C, BPSR15 and BPSRQ15

GENERAL

Fine quality sink bowl seamlessly formed of #20 gauge, type 304 (18-8) nickel bearing stainless steel. Self-rimming.

DESIGN FEATURES

Bowl Depth: 6-1/8".

Coved Corners: 1-3/4" vertical and horizontal radius.

Bowl and Faucet Deck Recess: 3/16" below outside edge of sink.

Finish: Exposed surfaces are polished to a lustrous highlighted satin finish.

Underside: Fully undercoated to dampen sound and prevent condensation.

These sinks comply with ANSI Standard A112.19.3M.

SINK PACKAGES

BPSRA150C Package includes:

- (1) **BPSR15** Sink.
- (1) **LK20888** Deluxe two-handle faucet with 4-1/2" rigid goose-neck spout.
- (1) **LK36** Strainer.

BPSH15C Package includes:

- (1) **BPSR15** Sink.
- (1) **LKA2437** Hi-Arc[®] two-handle bar faucet with 9" high (deck to aerator height) traditional swing spout.
- (1) **LK36** Strainer.

OTHER

Drain Opening: 2".

NOTE: Unless otherwise specified, sink is furnished with 1 faucet hole as shown. BPSH15C is furnished with 3 faucet holes.

OPTIONAL ACCESSORY

Cutting Board: CB912.

SINK DIMENSIONS (INCHES)*

U-Channel Model Number	Quick-Clip [®] Model Number	Overall		Inside Bowl			Cutout in Countertop (1 1/2" Radius Corners)		No. of 1 1/4" or 1 1/2" Dia. Faucet Holes 4" Centers	Minimum Cabinet Size	Ship. Wt. Lbs.
		L	W	L	W	D	L	W			
BPSRA150C	—	15	15	12	9 1/4	6 1/8	14 3/8	14 3/8	1	18	9 1/2
BPSH15C	—	15	15	12	9 1/4	6 1/8	14 3/8	14 3/8	3	18	9 1/2
BPSR15	BPSRQ15	15	15	12	9 1/4	6 1/8	14 3/8	14 3/8	1, 2, MR2 or 3	18	5 1/4

*Length is left to right. Width is front to back.

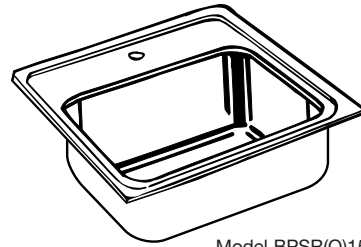

Model BPSR(Q)151

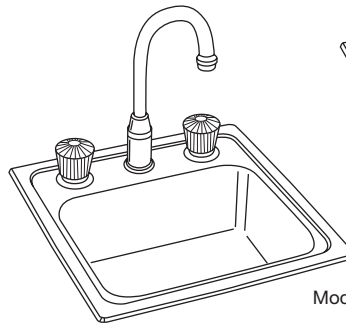

Model BPSH15C

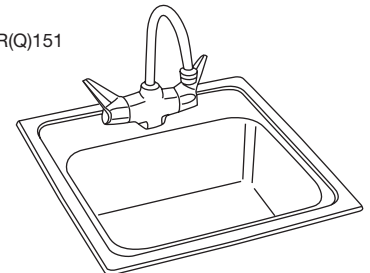

Model BPSRA150C

SEE OTHER SIDE FOR PRODUCT DIMENSIONS.

ALL DIMENSIONS IN INCHES, TO CONVERT TO MILLIMETERS MULTIPLY BY 25.4.

In keeping with our policy of continuing product improvement, Elkay reserves the right to change product specifications without notice.

This specification describes an Elkay product with design, quality and functional benefits to the user. When making a comparison of other producers' offerings, be certain these features are not overlooked.

**Pacemaker® Single Bowl Hospitality Sink
and Sink Packages
Models BPSRA150C, BPSH15C, BPSR15 and BPSRQ15**

**ELKAY®
SPECIFICATIONS**

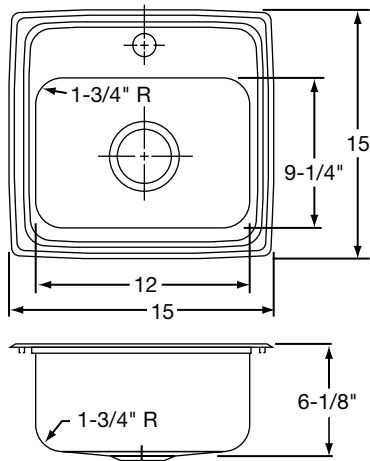

Model BPSR151 Illustrated

**HOLE DRILLING
CONFIGURATIONS**

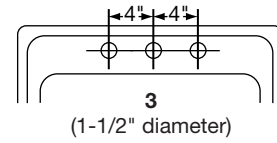
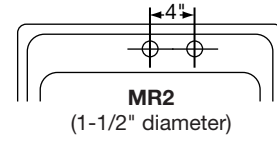
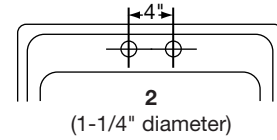
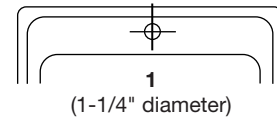

U-Channel Type Mounting System

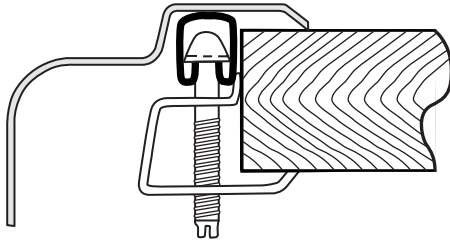

Quick-Clip® Mounting System

