

**PRODUCT SPECIFICATIONS**

Elkay Fireclay 33" x 18-13/16" x 9-5/8" Single Bowl Farmhouse Workstation Sink Kit, White. Sink is molded from fine fireclay with a durable porcelain glaze providing a finish that is non-porous and resists staining. Naturally sound deadening and Center Right drain placement.

<b>Installation Type:</b>	Farmhouse, Sink Kits
<b>Material:</b>	Fireclay
<b>Special Features:</b>	Workstation
<b>Finish:</b>	White (WH)
<b>Number of Bowls:</b>	1
<b>Sink Dimensions:</b>	33" x 18-13/16" x 10-1/8"
<b>Bowl 1 Dimensions:</b>	31-3/8" x 16-1/4" x 9-5/8"
<b>Drain Size:</b>	3-1/2" (89mm)
<b>Drain Location:</b>	Center Right
<b>Minimum Cabinet Size:</b>	36"
<b>Mounting Hardware:</b>	No
<b>Template Included:</b>	No



**Included with Product:** one LKCB1218HW cutting board, one LKOBG3015SS bottom grid, one LK99FC drain, and a LKCLKIT cleaning kit.

**Special Note:** Reserve Selection products are sold exclusively, in-store and online, through authorized wholesalers. Sink is reversible offering the option of a traditional flat front or a decorative band feature.



White (WH)

**AMERICAN PRIDE. A LIFETIME TRADITION.**

Like your family, the Elkay family has values and traditions that endure. For almost a century, Elkay has been a family-owned and operated company, providing thousands of jobs that support our families and communities.

**Product Compliance:** ASME A112.19.2/CSA B45.1  
**Accessory:** ASME A112.18.2/CSA B125.2



Sinks are listed by IAPMO® as meeting the applicable requirements of the Uniform Plumbing Code®, International Plumbing Code®, and National Plumbing Code of Canada.

[Clean and Care Manual \(PDF\)](#)  
[Installation Instructions \(PDF\) - 1000003608](#)  
[Warranty \(PDF\)](#)

**Installation Profile:**

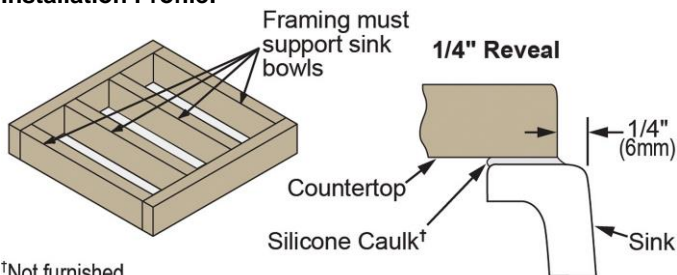



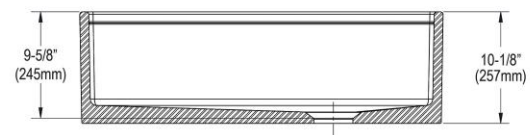
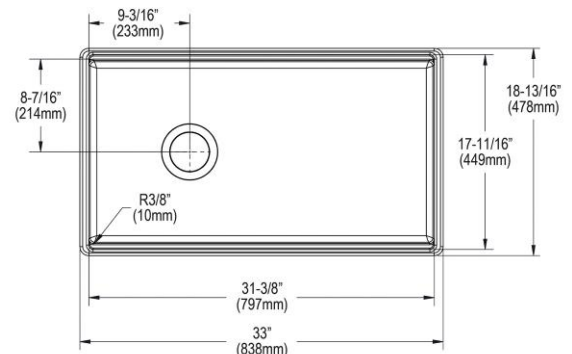

†Not furnished  
Designed to affix to the underside of any solid surface countertop.

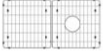

PART: \_\_\_\_\_ QTY: \_\_\_\_\_  
PROJECT: \_\_\_\_\_  
CONTACT: \_\_\_\_\_  
DATE: \_\_\_\_\_  
NOTES: \_\_\_\_\_  
APPROVAL: \_\_\_\_\_

In keeping with our policy of continuing product improvement, Elkay reserves the right to change product specifications without notice. Please visit [elkay.com](http://elkay.com) for the most current version of Elkay product specification sheets. This specification describes an Elkay product with design, quality, and functional benefits to the user. When making a comparison of other producers' offerings, be certain these features are not overlooked.

Included Accessories		
<a href="#">LK99FC</a>	Elkay Deluxe Drain 3-1/2" Type 304 Stainless Steel Body for Fireclay Sinks <a href="#">Spec Sheet (PDF)</a>	
<a href="#">LKCB1218HW</a>	Elkay Hardwood 12-1/2" x 17-5/16" x 1-1/2" Cutting Board <a href="#">Spec Sheet (PDF)</a>	
<a href="#">LKOBG3015SS</a>	Elkay Stainless Steel 30-1/4" x 15" x 1-3/8" Bottom Grid <a href="#">Spec Sheet (PDF)</a>	

Optional Accessories		
<a href="#">LK99FCS</a>	Elkay Deluxe Drain Kit with Satin Finish 3-1/2 Type 304 Stainless Steel Body for Fireclay Sinks <a href="#">Spec Sheet (PDF)</a>	
<a href="#">LKEC2037</a>	Elkay Explore Three Hole Bridge Faucet with Pull-down Spray and Lever Handles <a href="#">Spec Sheet (PDF)</a>	

*In keeping with our policy of continuing product improvement, Elkay reserves the right to change product specifications without notice. Please visit [elkay.com](http://elkay.com) for the most current version of Elkay product specification sheets. This specification describes an Elkay product with design, quality, and functional benefits to the user. When making a comparison of other producers' offerings, be certain these features are not overlooked.*