

PRODUCT SPECIFICATIONS

Lustertone® Stainless Steel Single Bowl Top Mount Quick-Clip® Sink + Faucet Kit. Overall dimensions are 22" x 19-1/2" x 4". Sink is manufactured from 18 gauge 304 Stainless Steel with a Lustrous Highlighted Satin finish, Rear Center drain placement and Full spray sides and bottom.

Installation Type:	Top Mount
Material:	304 Stainless Steel
Special Features:	Quick-Clip Mounting System
Finish:	Lustrous Highlighted Satin
Gauge:	18
Sound Deadening:	Full spray sides and bottom
Number of Bowls:	1
Sink Dimensions:	22" x 19-1/2" x 4"
Bowl 1 Dimensions:	13-1/2" x 16" x 3-7/8"
Drain Size:	3-1/2" (89mm)
Drain Location:	Rear Center
Minimum Cabinet Size:	27"
Mounting Hardware:	Included for 3/4" (19mm) countertop
Cutout Template #:	1000001255

Template is available for download at [elkay.com](#)

Cutout Dimensions for Top Mount Installation:

21-3/8" x 18-7/8" (543mm x 479mm) with 1-1/2" (38mm) corner radius

 This sink is compliant to ADA and ANSI/ICC A117.1 accessibility requirements when installed according to the requirements outlined in these standards.

Installation Profile:

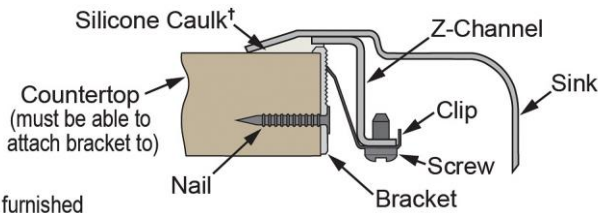

†Not furnished

OPTIONAL ACCESSORIES

Sinkmate:	LKSM17, LKSMHOOK, LKSMSPONGE, LKSMHSL
------------------	---------------------------------------



Included with Product: LKD2439C faucet, LK1141A bubbler, LK35 strainer

AMERICAN PRIDE. A LIFETIME TRADITION. Like your family, the Elkay family has values and traditions that endure. For almost a century, Elkay has been a family-owned and operated company, providing thousands of jobs that support our families and communities.

Product Compliance: ADA
ASME A112.19.3/CSA B45.4
Faucet: ASME A112.18.1/CSA B125.1
NSF 372 (lead free)
NSF 61
Accessory: ASME A112.18.2/CSA B125.2

[Clean and Care Manual \(PDF\)](#)
[Installation Instructions \(PDF\) - 74180271](#)
[Installation Instructions \(PDF\) - A55068 Bubbler](#)
[Installation Instructions \(PDF\) - P99175 Faucet](#)
[Limited Lifetime Warranty \(PDF\)](#)

Similar models are available with: additional ADA depths, U Channel mounting system

PART: _____ QTY: _____
PROJECT: _____
CONTACT: _____
DATE: _____
NOTES: _____
APPROVAL: _____

In keeping with our policy of continuing product improvement, Elkay reserves the right to change product specifications without notice. Please visit [elkay.com](#) for the most current version of Elkay product specification sheets. This specification describes an Elkay product with design, quality, and functional benefits to the user. When making a comparison of other producers' offerings, be certain these features are not overlooked.

1-1/2" (38mm) Diameter Faucet Holes on 4" (102mm) Centers
1-1/8" (29mm) Diameter Slotted Hole

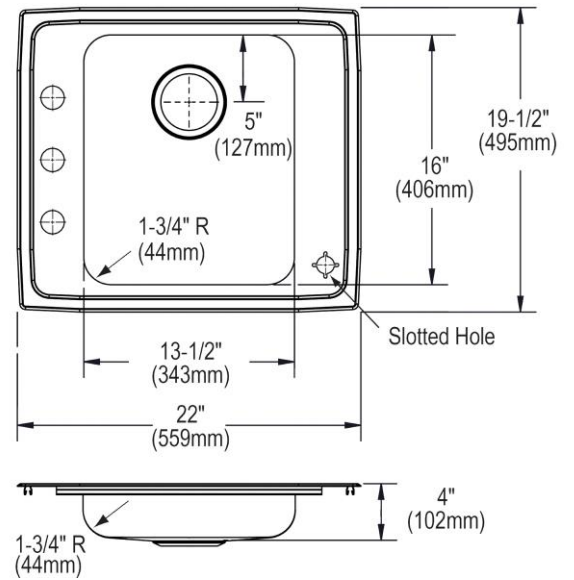

In keeping with our policy of continuing product improvement, Elkay reserves the right to change product specifications without notice. Please visit elkay.com for the most current version of Elkay product specification sheets. This specification describes an Elkay product with design, quality, and functional benefits to the user. When making a comparison of other producers' offerings, be certain these features are not overlooked.