



Use & Care Guide

Electric Slide-In Range



 **Electrolux**

2 Finding Information

MAKE A RECORD FOR FUTURE USE

Brand _____

Purchase Date _____

Model Number _____

Serial Number _____

MODEL AND SERIAL NUMBER LOCATION

NOTE

The serial plate is located along the interior side trim of the oven and visible when the door is opened. See picture below.

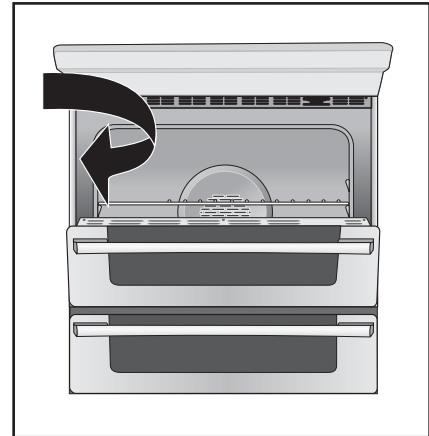

QUESTIONS?

For toll-free telephone support in the U.S. and Canada:
1-877-4ELECTROLUX (1-877-435-3287)

For online support and internet product information:
www.electroluxappliances.com

TABLE OF CONTENTS

Finding Information.....	2	Electronic Control Settings	33
Make a Record for Future Use	2	User Preference Menu.....	33
Model and Serial Number Location	2	Setting the Clock - Time of day.....	33
Questions?.....	2	Setting Clock Display - On or Off.....	34
Table of Contents.....	3	Setting Time of Day - 12 or 24 hours.....	34
Safety.....	4	Setting Temperature Display - °F or °C.....	34
Important Safety Instructions	4-7	Setting Continuous Bake or 12 Hour	
Feature Overview.....	8	Energy Saving	34
Your Slide-In Range.....	8-9	Audio Control	35
Oven Rack Supports and Oven Vents.....	10	Adjusting Oven Temperature	35
Removing and Replacing Oven Racks.....	11	Re-setting to Default Factory Settings.....	35
Control Pad Functions	12-14	Oven Controls.....	36
Getting Started.....	15	My Favorite	36
Setting Clock at Power Up.....	15	Sabbath Feature	37-38
Temperature Visual Display	15	Care & Cleaning.....	39
Oven Light	16	Using the Self-Clean Feature	39
Control Lock.....	16	Starting the Self-Clean Cycle.....	40
Setting the Kitchen Timer.....	16	General Cleaning.....	41
Setting Surface Controls	17	Care and Cleaning of Stainless Steel.....	42
About the Ceramic Glass Cooktop	17	To Remove and Replace Oven Door	42
About the Radiant Surface Elements.....	17	Special Door Care Instructions	42
Surface Cooking Utensils	18	Oven Light	43
Cookware Material Types	18	Broiler Pan Cleaning Tips	43
Setting the Cooktop	19-20	Cooktop Cleaning and Maintenance.....	44
Setting the Warmer Oven.....	21	Cleaning Recommendations for the	
Warmer Oven Operation.....	21	Ceramic Glass Cooktop.....	44-45
Cooking Modes.....	22	Solutions to Common Problems.....	46
Baking.....	22	Baking Problems.....	46
Cook Time.....	23	Solutions	47-50
End Time.....	23	Notes.....	51
Broiling.....	24	Warranty Information	52
Convection Baking.....	25		
Convection Convert	26		
Rapid Preheat.....	26		
Convection Roasting.....	27		
Convection Broiling.....	28		
Keep Warm	29		
Slow Cook.....	30		
Dehydrating	31		
Bread Proofing.....	32		

4 Safety

IMPORTANT SAFETY INSTRUCTIONS

⚠ WARNING

Tip Over Hazard

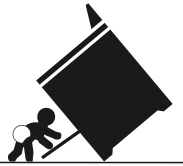

- A child or adult can tip the range and be killed.
- Verify the anti-tip device has been installed to floor or wall.
- Ensure the anti-tip device is re-engaged to floor or wall when the range is moved.
- Do not operate the range without the anti-tip device in place and engaged.
- Failure to follow these instructions can result in death or serious burns to children and adults.



To check if the anti-tip bracket is installed properly, use both arms and grasp the rear edge of range back. Carefully attempt to tilt range forward. When properly installed, the range should not tilt forward.

Refer to the anti-tip bracket **installation instructions** supplied with your range for proper installation.

- **Remove all tape and packaging wrap before using the appliance. Destroy the carton and plastic bags after unpacking the appliance.** Never allow children to play with packaging material.
- **Proper Installation—Be sure your appliance is properly installed and grounded by a qualified technician in accordance in the United States with National Electrical Code ANSI/NFPA No. 70—latest edition and local code requirements, and in Canada with CSA C22.1 PART 1—latest edition and local code requirements.** Install only per installation instructions provided in the literature package for this appliance.

Ask your dealer to recommend a qualified technician and an authorized repair service. Know how to disconnect the electrical power to the range at the circuit breaker or fuse box in case of an emergency.

- **User Servicing—Do not repair or replace any part of the appliance unless specifically recommended in the manuals.** All other servicing should be done only by a qualified technician to reduce the risk of personal injury and damage to the appliance.
- **Never modify or alter the construction of a range by removing leveling legs, panels, wire covers, anti-tip brackets/screws, or any other part of the product.**

⚠ WARNING Stepping, leaning or sitting on the door or drawer of this appliance can result in serious injuries and may also cause damage to the appliance. Do not allow children to climb or play around the appliance. The weight of a child on an open door may cause the appliance to tip, resulting in serious burns or other injury. An open drawer, when hot, may cause burns.

⚠ WARNING Do not use the oven or warmer drawer (if equipped) for storage.

- **Storage in or on Appliance—Flammable materials should not be stored in an oven, near surface units or in the drawer (if equipped).** This includes paper, plastic and cloth items, such as cookbooks, plasticware and towels, as well as flammable liquids. Do not store explosives, such as aerosol cans, on or near the appliance. Flammable materials may explode and result in fire or property damage.

⚠ CAUTION Do not store items of interest to children in the cabinets above the appliance. Children climbing on the range to reach items could be seriously injured.

- **Do not leave children alone. Children should not be left alone or unattended in the area where an appliance is in use.** They should never be allowed to sit or stand on any part of the appliance.

- **DO NOT TOUCH SURFACE UNITS, AREAS NEAR THESE UNITS, OVEN HEATING ELEMENTS OR INTERIOR SURFACES OF THE OVEN OR WARMER DRAWER (if equipped).** Both surface units and oven heating elements may be hot even though they are dark in color. Areas near surface units may become hot enough to cause burns. During and after use, do not touch, or let clothing or other flammable materials touch these areas until they have had sufficient time to cool. Among these areas are the cooktop, surfaces facing the cooktop, the oven vent openings and surfaces near these openings, oven door and window.
- **Wear Proper Apparel—Loose-fitting or hanging garments should never be worn while using the appliance.** Do not let clothing or other flammable materials contact hot surfaces.

⚠ WARNING To reduce the risk of burns, **DO NOT** move this appliance while hot. This appliance is provided with casters to facilitate movement. To reduce the risk of injury due to tipping of the appliance, verify the reinstallation of this appliance into the anti-tip device provided after returning the appliance to the original installed position.

⚠ WARNING Never use your appliance for warming or heating the room.

- **Do Not Use Water or Flour on Grease Fires—Smother the fire with a pan lid, or use baking soda, a dry chemical or foam-type extinguisher.**
- **When heating fat or grease, watch it closely.** Fat or grease may catch fire if allowed to become too hot.
- **Use Only Dry Potholders—Moist or damp potholders on hot surfaces may result in burns from steam.** Do not let the potholders touch hot heating surface units or interior oven elements. Do not use a towel or other bulky cloth instead of a potholder.
- **Do Not Heat Unopened Food Containers—Build up of pressure may cause the container to burst and result in injury.**
- **Remove the oven door from any unused appliance if it is to be stored or discarded.**
- **IMPORTANT—Do not attempt to operate the oven during a power failure. If the power fails, always turn the oven off.** If the oven is not turned off and the power resumes, the oven may begin to operate again. Food left unattended could catch fire or spoil.

⚠ CAUTION Electronic controllers can be damaged by cold temperatures. When you use your appliance for the first time, or if it has not been used for a long period of time, make sure that it has been exposed to a temperature above 0°C/32°F for at least 3 hours before connecting it to the power supply.

IMPORTANT INSTRUCTIONS FOR USING YOUR COOKTOP

- **Know which knob controls each surface heating unit.**
- **Use Proper Pan Size—**This appliance is equipped with one or more surface units of different sizes. Select utensils having flat bottoms large enough to cover the surface unit. The use of undersized utensils will expose a portion of the surface heating unit to direct contact and may result in ignition of clothing. Proper relationship of utensil to the surface unit will also improve efficiency.
- **Utensil Handles Should Be Turned Inward and Should Not Extend Over Adjacent Surface Units—**To reduce the risk of burns, ignition of flammable materials, and spillage due to unintentional contact with the utensil. The handle of the utensil should be positioned so that it is turned inward, and does not extend over adjacent surface unit.

6 Safety

- **Never Leave Surface Units Unattended**—Boilovers cause smoking and greasy spillovers that may ignite, or a pan that has boiled dry may melt.
- **Protective liners**— Do not use aluminum foil to line oven bottom or any other part of the appliance. Only use aluminum foil as recommended for baking if used as a cover placed on the food. Any other use of protective liners or aluminum foil may result in a risk of electric shock or fire or a short circuit.
- **Glazed Cooking Utensils**—Only certain types of glass, glass/ceramic, ceramic, earthenware, or other glazed utensils are suitable for cooktop service without breaking due to the sudden change in temperature. Check the manufacturer's recommendations for cooktop use.
- **Do Not Use Decorative Surface Element Covers.** If an element is accidentally turned on, the decorative cover will become hot and possibly melt. Burns will occur if the hot covers are touched. Damage may also be done to the cooktop.

FOR GLASS COOKTOPS ONLY

- **Do Not Clean or Operate a Broken Cooktop** —If cooktop should break, cleaning solutions and spillovers may penetrate the broken cooktop and create a risk of electric shock. Contact a qualified technician immediately.
- **Clean Cooktop Glass with Caution**—If a wet sponge or cloth is used to wipe spills on a hot cooking area, be careful to avoid a steam burn. Some cleaners can produce harmful fumes if applied to a hot surface.
- **Avoid scratching the cooktop glass with sharp objects.**

IMPORTANT INSTRUCTIONS FOR USING YOUR OVEN

- **Use Care When Opening Door or Drawer**—Stand to the side of the appliance when opening the door of a hot oven. Let hot air or steam escape before you remove or replace food in the oven/warmer drawer.
 - **Keep Oven Vent Ducts Unobstructed.** The oven is vented at the front above the oven door (ceramic glass cooktop models) or through the right rear element (coil element models). Touching the surfaces in this area when the oven is operating may cause severe burns. Also, do not place plastic or heat-sensitive items on or near the oven vent. These items could melt or ignite.
 - **Placement of Oven/Warmer Drawer (if equipped) Racks.** Always place oven racks in desired location while oven/drawer (if equipped) is cool. Remove all utensils from the rack before removing rack. If rack must be moved while oven is hot, use extreme caution. Use potholders and grasp the rack with both hands to reposition. Do not let potholders contact the hot oven element or interior of the oven/warmer drawer (if equipped).
 - **Do not use a broiler pan without its insert.** The broiler pan and grid allow dripping fat to drain and be kept away from the high heat of the broiler.
 - **Do not cover your broiler or warmer drawer (if equipped) grid with aluminum foil.** Exposed fat and grease could ignite.
 - **Do not touch a hot light bulb with a damp cloth.** Doing so could cause the bulb to break. Disconnect the appliance or turn off the power to the appliance before removing and replacing light bulb.
-

IMPORTANT INSTRUCTIONS FOR CLEANING YOUR RANGE

- **Clean the range regularly to keep all parts free of grease that could catch fire.** Exhaust fan ventilation hoods and grease filters should be kept clean. Do not allow grease to accumulate. Greasy deposits in the fan could catch fire. Refer to the hood manufacturer's instructions for cleaning.
- **Cleaners/aerosols**—Always follow the manufacturer's recommended directions for use. Be aware that excess residue from cleaners and aerosols may ignite causing damage and/or injury.

SELF-CLEANING OVENS:

- **Clean in the self-cleaning cycle only the parts of the oven listed in this owner's guide.** Before self-cleaning the oven, remove all utensils stored in the oven.
- **Do not clean the oven door gasket.** The door gasket is essential for a good seal. Care should be taken not to rub, damage or move the gasket.
- **Oven racks.** Oven racks will be damaged if left in the oven during a self-cleaning cycle.
- **Do not use oven cleaners.** No oven cleaner or oven liner protective coating of any kind should be used in or around any part of the oven.
- **Remove oven racks.** Oven racks will be damaged if left in the oven during a self-cleaning cycle.

⚠ CAUTION The health of some birds is extremely sensitive to the fumes given off during the self-clean cycle of any range. Move birds to another well ventilated room.

IMPORTANT SAFETY NOTICE

The California Safe Drinking Water and Toxic Enforcement Act requires the Governor of California to publish a list of substances known to the state to cause cancer, birth defects or other reproductive harm, and requires businesses to warn customers of potential exposure to such substances.

NOTE

Save these important safety instructions for future reference.

8 Feature Overview

YOUR SLIDE-IN RANGE

CERAMIC GLASS COOKTOP

TOUCH GLASS
CONTROL PANEL

LARGE METAL HANDLE

CURVED GLASS
OVEN DOOR

WARMER OVEN DOOR
WINDOW GLASS

SINGLE ELEMENT
6" 1200W

SINGLE
ELEMENT
6" 1200W

DOUBLE
ELEMENT
5" 750W
7" 1800W

DOUBLE
ELEMENT
9" 1800W
12" 3000W

DOUBLE
ELEMENT
6" 1600W
9" 3000W

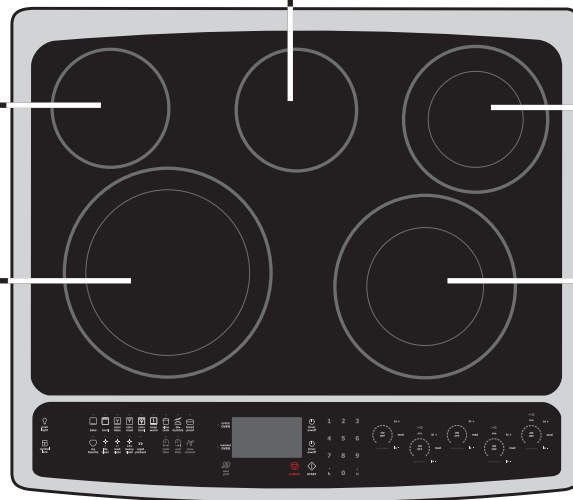

YOUR SLIDE-IN RANGE

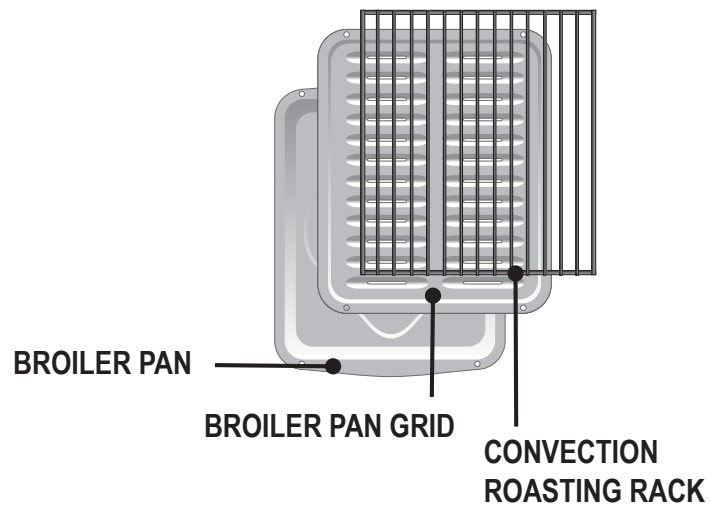
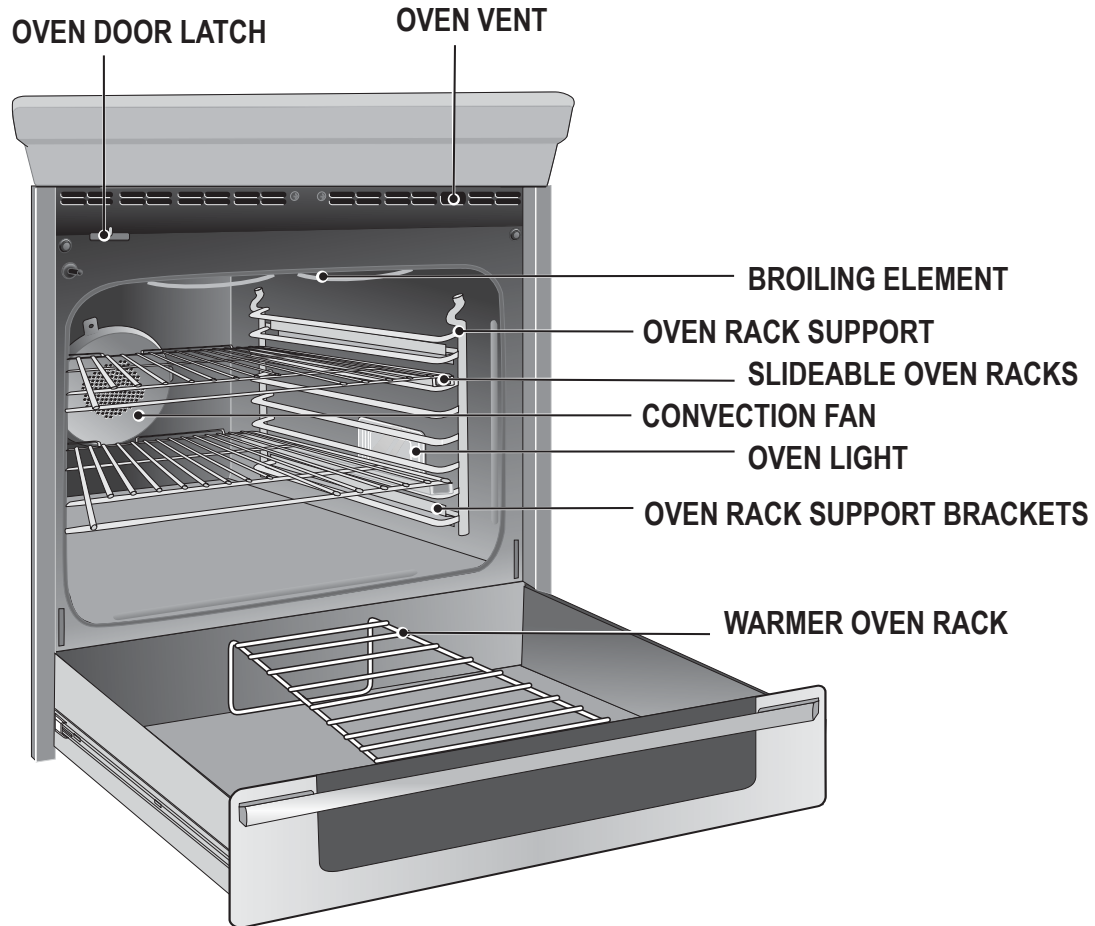

10 Feature Overview

OVEN RACK SUPPORTS & OVEN VENTS

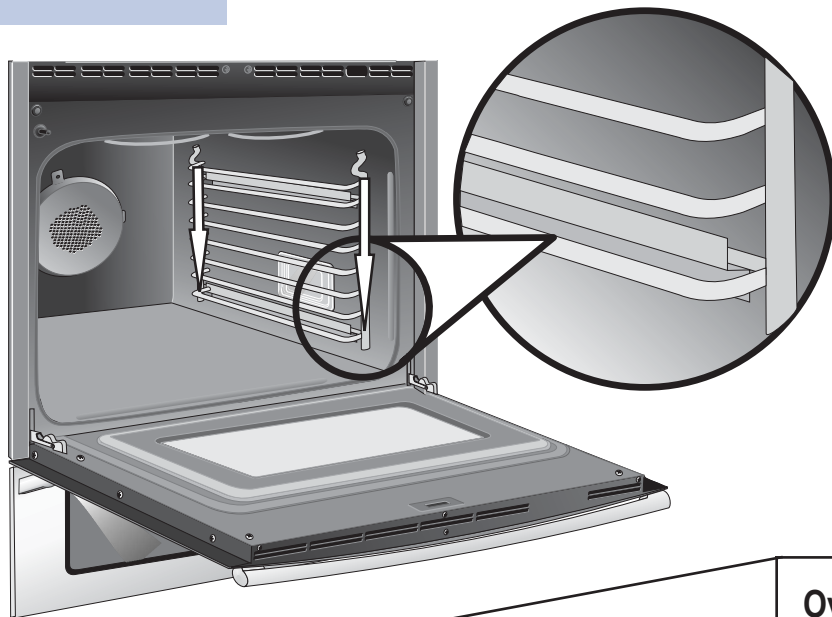

Installing Oven Rack Supports

ALWAYS INSTALL OVEN RACK SUPPORT BEFORE TURNING ON THE OVEN (WHEN THE OVEN IS COOL).

To install oven rack support, insert the supports by pushing them downward into the two brackets on each side of the oven interior, as shown below.

To remove the oven rack support for a self-clean cycle, pull up the support to disengage them from the brackets. If the rack supports are not removed, the self-clean cycle won't start.

Oven Rack Positions

This oven is equipped with ladder rack supports with 8 positions to accommodate precisely every mode of cooking.

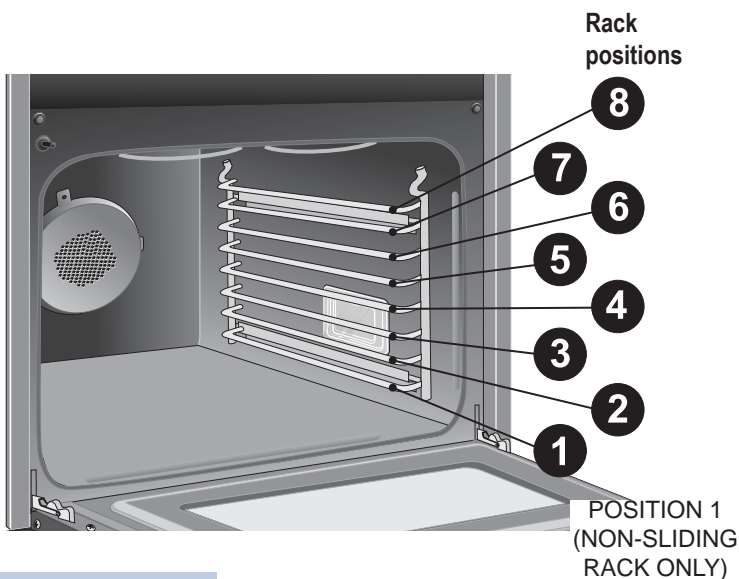

Oven Vents Location

The oven is vented **above each door**. When the oven is on, warm air is released through the vents. This venting is necessary for proper air circulation in the oven and good baking results.

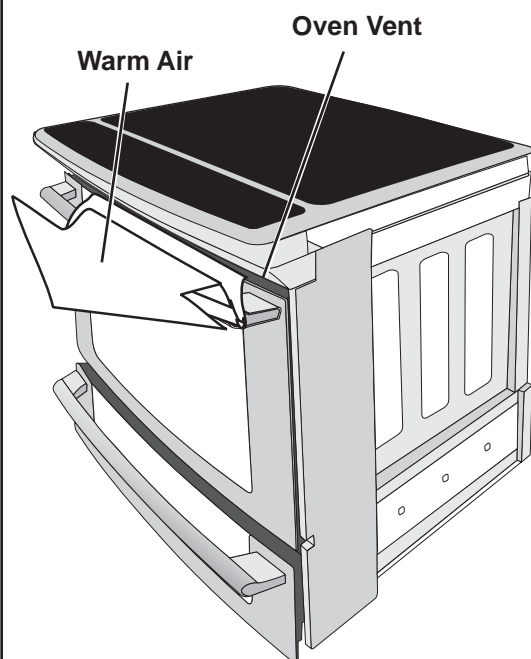

REMOVING AND REPLACING OVEN RACKS

Removing Sliding Oven Racks

1. With the rack in its closed position; grasp the rack and the sliders at once.
2. Slightly lift the rack and sliders and pull it to clear the first bracket.
3. Pull the rack and sliders until the second bracket stops the rack.
4. Lift the rack and sliders and carefully remove them from the oven.

Refer to the care and cleaning section for directions on how to clean the racks.

Replacing Sliding Oven Racks

To replace the oven racks, follow the instructions above in reverse order.

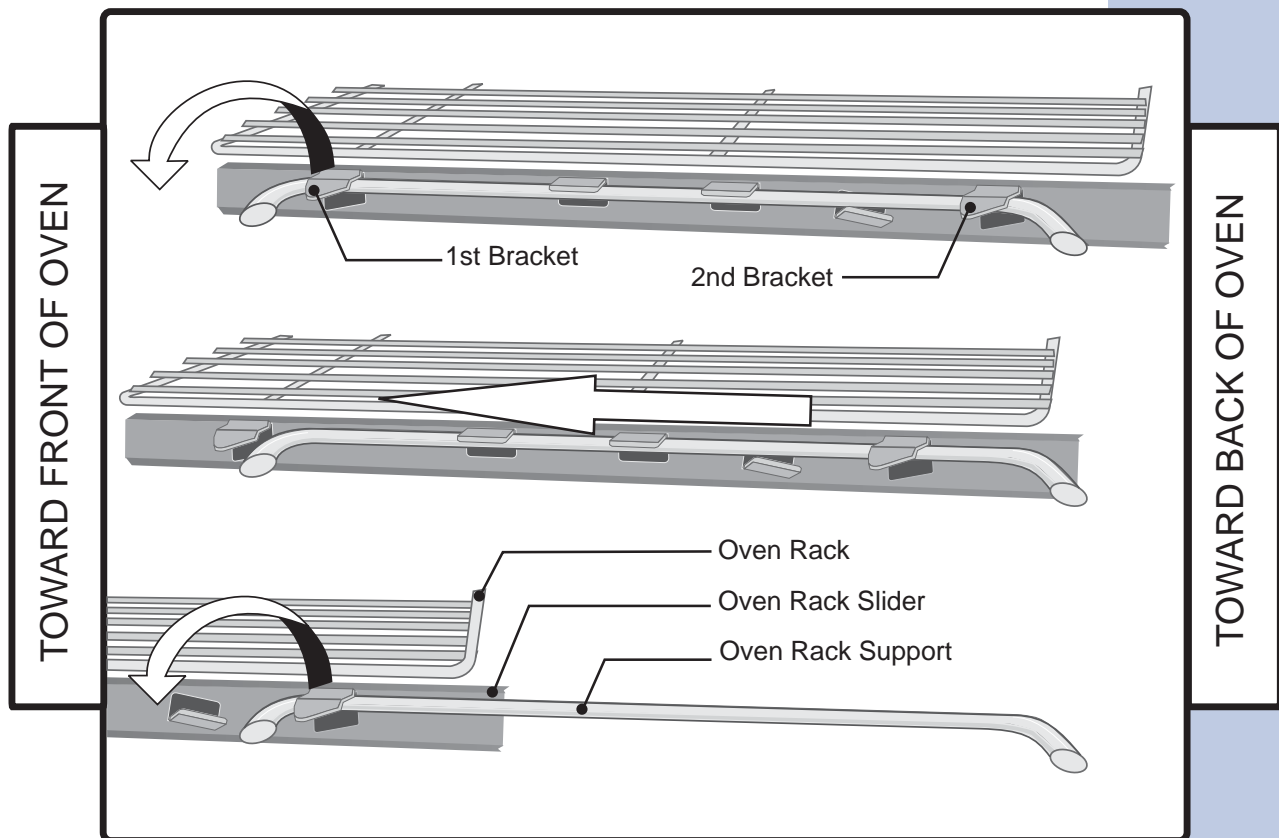

Removing Non-Sliding Oven Rack

Simply pull the rack and slightly tilt it upward when the rack hits its stop position.

Replacing Non-Sliding Oven Rack

Insert the rack into the oven rack supports by inserting the rack openings into the rack supports. Be sure the rack is at the same position on each oven rack support on both sides.

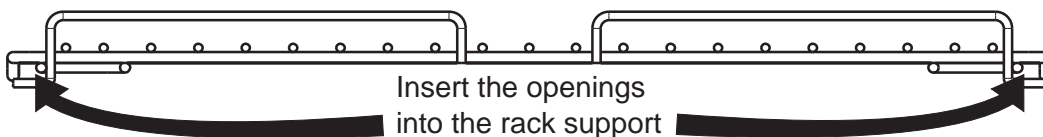

⚠ WARNING Always arrange the oven racks when the oven is cool (prior to operating the oven). Always use oven mitts when using the oven.

12 Feature Overview

CONTROL PAD FUNCTIONS

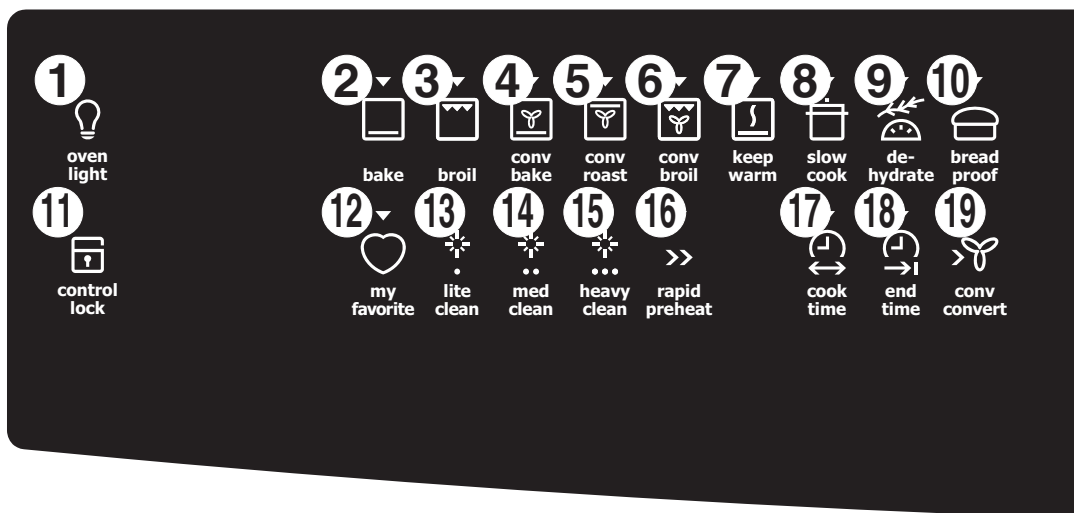

- 1 Light Pad-** Used to turn the oven light on and off.
- 2 Bake Pad-** Used to enter the normal baking mode temperature.
- 3 Broil Pad-** Used to select the variable broil mode.
- 4 Convection Bake Pad-** Used to select the convection baking mode.
- 5 Convection Roast Pad-** Used to select the convection roasting mode.
- 6 Convection Broil Pad-** Used to select the convection broil mode.
- 7 Keep Warm Pad-** Used to select the keep warm mode.
- 8 Slow Cook Pad-** Used to select the slow cook mode.
- 9 Dehydrate Pad-** Used to select the dehydrate mode.
- 10 Bread Proof Pad-** Used to select the bread proof mode.
- 11 Control Lock Pad-** Used to disable all oven function.
- 12 My Favorite 3 Pad-** Used to save or recall the favorite 3 cooking mode.
- 13 Lite Clean Pad-** Used to start a 2 hours self-clean cycle.
- 14 Med Clean Pad-** Used to start a 3 hours self-clean cycle.
- 15 Heavy Clean Pad-** Used to start a 4 hours self-clean cycle.
- 16 Rapid Preheat Pad-** Used to preheat the oven to the desired temperature.
- 17 Cook Time Pad-** Used to set a cooking duration time.
- 18 End Time Pad-** Used to select the time at which the cooking will end.
- 19 Conv. Convert Pad-** Used to convert a standard temperature to a convection temperature.

CONTROL PAD FUNCTIONS (CONTINUED)

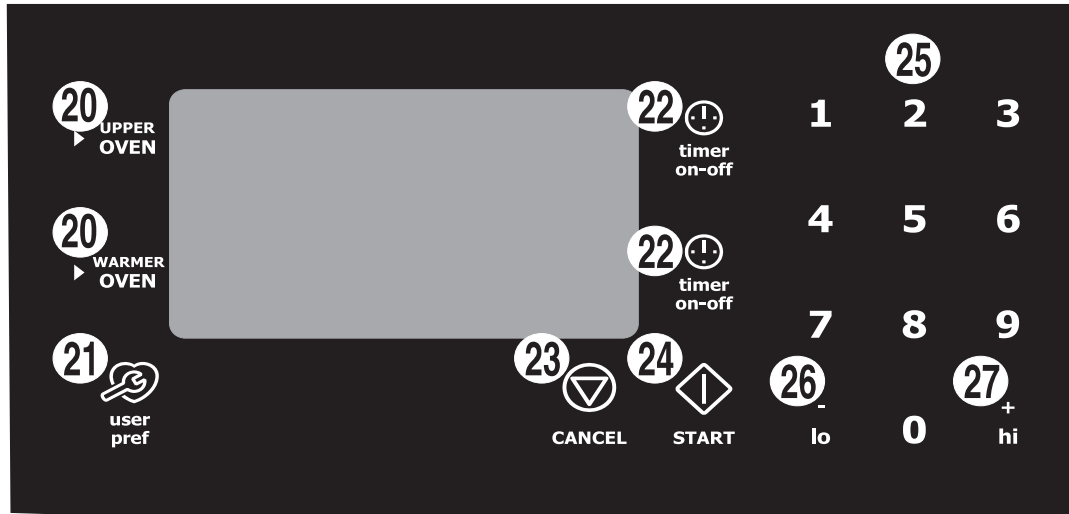

- 20 **Upper Oven Pad**- Used to activate the upper oven for cooking operation.
- 20 **Warmer Oven Pad**- Used to activate the warmer oven for warming operation.
- 21 **User Preference Pad**- Used to bring the user preference menu in the display.
- 22 **Timer on-off Pads**- Used to set or cancel the minute timer. The minute timer does not start or stop cooking.
- 23 **Cancel Pad**- Used to cancel any function previously entered except the time of day and minute timer. Push **Cancel pad** to stop cooking.
- 24 **Start Pad**- Used to start all oven functions.
- 25 **0 Thru 9 Number Pads**- Used to enter temperature and times.
- 26 **- lo Pad**- Used to lower the temperature and times.
- 27 **+ hi Pad**- Used to raise the temperature and times.

14 Feature Overview

CONTROL PAD FUNCTIONS

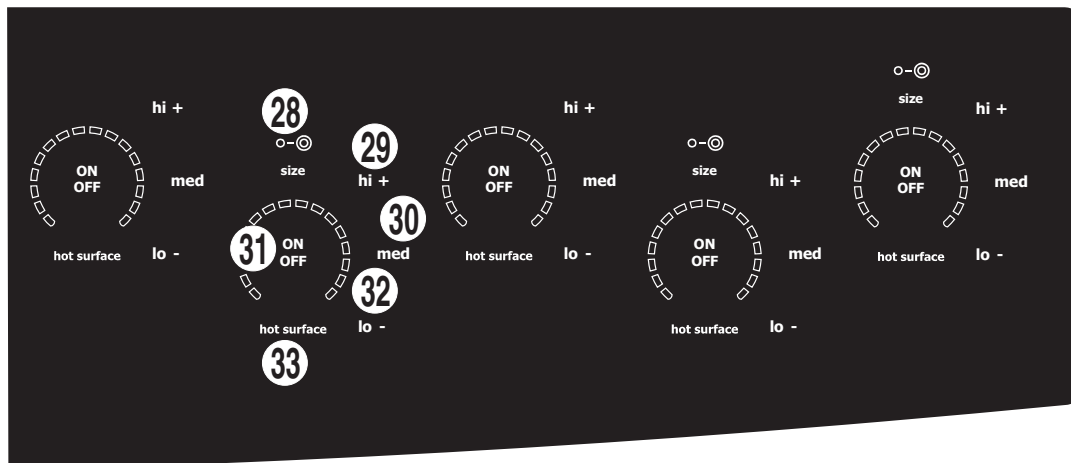



- 28 **Burner Size Pad**- Used to toggle between the available surface element burner sizes.
- 29 **HI + Pad**- Used to select the highest element temperature or raise the temperature currently displayed.
- 30 **MED Pad**- Used to select the medium element temperature.
- 31 **ON / OFF Pad**- Used to toggle ON and OFF the associated surface element.
- 32 **LO - -** Used to select the lower element temperature or lower the temperature currently displayed.
- 33 **Hot surface** indicator light- Used to indicate that the element is still hot.

SETTING CLOCK AT POWER UP

When the unit is first plugged in, or when the power supply to the range has been interrupted, the timer in the display will flash with "12:00". The clock cannot be set when the oven is on. If an invalid time of day is entered, the control will triple beep to prompt you to re-enter a valid time of day.

To set the clock (example for 1:30):

1. Press **1** **3** **0** pads to set the time of day to 1:30. The pads **hi** or **lo** can also be pressed to raise or lower the actual time displayed.
2. Press **START**  to accept the changes or **CANCEL**  to start with a time of 12:00.

TEMPERATURE VISUAL DISPLAY

Your oven is equipped with a temperature visual display for each oven. When a cooking mode is set, the actual temperature will be shown in the display and will rise as the unit preheat. When the unit has reached its target temperature, a chime will sound to remind you to place the food in the oven. This feature will be active with some cooking modes; bake, convection bake and convection roast. The cooking modes which does not feature the temperature visual display will be noted in their descriptions.

NOTE: The lowest temperature that can be displayed is 100°F.

16 Getting Started

OVEN LIGHT



Your appliance includes “theater” style oven lighting feature that gradually lights both the upper and lower oven interiors to full brightness. The upper oven is equipped with 2 halogen lights and the lower oven is equipped with 1 incandescent light. The oven lights will turn on automatically when the oven door is opened. The oven light may be turned on when the door is closed by using the oven light pad located on the control panel. The oven light key will toggle the lights in both ovens at the same time at full intensity.

To toggle the Oven Lights ON and OFF:

1. Press **OVEN LIGHT** .

CONTROL LOCK



The Control Lock feature automatically locks the upper oven door, control panel and the cooktop. The Control Lock is only allowed when the oven and the cooktop are turned OFF (not active). **DOOR LOCK** will flash in the display for 20 seconds or until the door has finished locking. Once the door has been locked, **Loc** message will appear in the upper display and lights (Fig. 1) will appear in the cooktop displays. Do not attempt to open the oven door while **DOOR LOCK** is flashing.

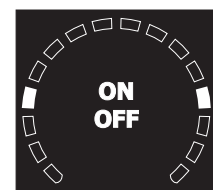
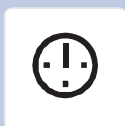

Fig. 1

To toggle the Control Lock ON and OFF:





1. Keep **CONTROL LOCK**  pressed for 3 seconds.

SETTING THE KITCHEN TIMER



This unit is equipped with 2 Kitchen Timers which serves as extra timers in the kitchen that will beep when the set time has run out. It does not start or stop cooking. The Timer feature can be used during any of the other oven control functions and cooking modes.

To set the Timer (example for 5 minutes):

1. Press **TIMER** . “00:00” will appear in the display.
2. Press  pad to set the timer to 5 minutes. The pads **hi** or **lo** can also be pressed to raise or lower the actual time displayed.
3. Press again **TIMER**  to accept and start the countdown.
4. When the set time has run out, “00:00” will be displayed and the **TIMER**  pad will flash. The clock will sound a chime that will be repeated at regular intervals until the **TIMER**  pad is pressed.

To cancel the Timer before the set time has run out:

Press **TIMER** . The display will return to the time of day.

ABOUT THE CERAMIC GLASS COOKTOP

The ceramic cooktop has radiant surface elements located below the surface of the glass. The design of the ceramic cooktop outlines the area of the surface element underneath. **Make sure** the diameter of the pan matches the diameter of the element outline on the cooktop. Heat is transferred up through the surface of the cooktop to the cookware. Only flat-bottom cookware should be used. The type and size of cookware, the number of surface elements in use and the settings, are all factors that will affect the amount of heat that will spread to areas beyond the surface elements. The areas surrounding the elements may become **hot enough to cause burns**.

ABOUT THE RADIANT SURFACE ELEMENTS

The element temperature rises gradually and evenly. As the temperature rises, the element will glow red. To maintain the selected setting, the element will cycle on and off. The heating element retains enough heat to provide a uniform and consistent heat during the off cycle. For efficient cooking, turn off the element several minutes before cooking is complete. This will allow residual heat to complete the cooking process.

Your range is equipped with radiant surface burners with different wattage ratings. The ability to heat food quicker and in larger volumes increases as the element wattage increases.

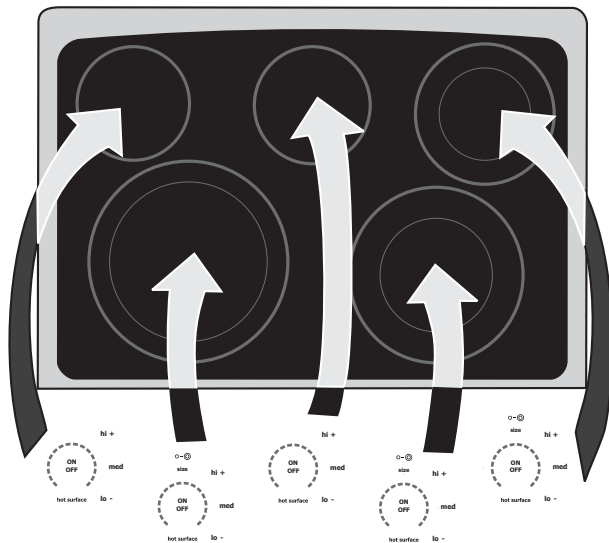

NOTE

Radiant elements have a limiter that allows the element to cycle ON and OFF, even at the HI setting. This helps to prevent damage to the ceramic glass cooktop. Cycling at the HI setting is normal and can also occur if the cookware is too small for the radiant element or if the cookware bottom is not flat (Refer to page 18 for using correct cookware instructions with the cooktop).

Please read detailed instructions for ceramic glass cooktop cleaning in the **General Care & Cleaning** section and **Solutions to Common Problems** section of this Use and Care Guide.

18 Setting Surface Controls

SURFACE COOKING UTENSILS

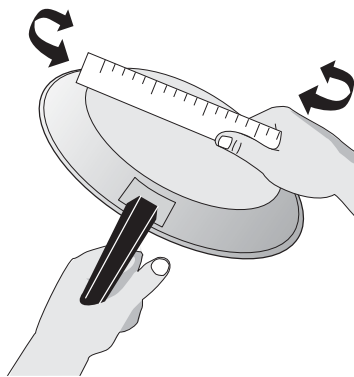

Cookware should have flat bottoms that make good contact with the entire surface heating element. Check for flatness by rotating a ruler across the bottom of cookware. Be sure to follow the recommendations for using cookware that is shown in the illustrations at right.

Note: Always use a cooking utensil for its intended purpose. Follow manufacturer's instructions. Some utensils were not made to be used in the oven or on the cooktop.

Specialty pans such as lobster pots, griddles and pressure cookers may be used but must conform to the above recommended cookware requirements.

Note: The size and type of cookware used will influence the setting needed for best cooking results.

GOOD

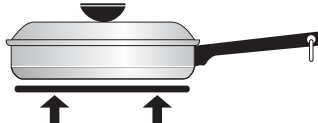

- Flat bottom and straight sides.
- Tight fitting lids.
- Weight of handle does not tilt pan. Pan is well balanced.
- Pan sizes match the amount of food to be prepared and the size of the surface element.
- Made of material that conducts heat well.
- Easy to clean.
- Always match pot diameter to element surface diameter.

POOR



- Curved and warped pan bottoms.



- Pan overhangs unit by more than 2.5 cm (1").



- Heavy handle tilts pan.



- Pan is smaller than element.

COOKWARE MATERIAL TYPES

The cookware material determines how evenly and quickly heat is transferred from the surface element to the pan bottom. The most popular materials available are:

ALUMINUM - Excellent heat conductor. Some types of food will cause it to darken (Anodized aluminum cookware resists staining & pitting). If aluminum pans slide across the ceramic glass cooktop, they may leave metal marks which will resemble scratches. Remove these marks immediately.

COPPER - Excellent heat conductor but discolors easily. May leave metal marks on ceramic glass (see Aluminum above).

STAINLESS STEEL - Slow heat conductor with uneven cooking results. Is durable, easy to clean and resists staining.

CAST IRON - A poor heat conductor however will retain heat very well. Cooks evenly once cooking temperature is reached. Not recommended for use on ceramic cooktops.

PORCELAIN-ENAMEL on METAL - Heating characteristics will vary depending on base material. Porcelain-enamel coating must be smooth to avoid scratching ceramic cooktops.

GLASS - Slow heat conductor. Not recommended for ceramic cooktop surfaces because it may scratch the glass.

SETTING THE COOKTOP

The cooktop controls provide display to help set power levels for the cooking zones located on the cooktop. These settings work the same way as traditional knob settings except the settings are made using a touch sensitive panel and show settings using LED style displays.

Available cooktop settings

Your control control provides different power level settings for each of the cooking or heating zones. These displays have keypads that allow the user to first activate (**ON/OFF**) the needed element and then to quickly turn that element ON using 3 preset power levels (**lo**, **med** or **hi**) - see Figs. 2 through 5 -.

In addition to the automatic settings, the **+** and **-** keypads allows for more precise level adjustments between the automatic settings.

Element size indicators

Some cooktop zone positions display additional size keypads - see Fig 1- that allows the user to switch between single or dual elements sizes quickly whenever the cooking zone is active.

Hot Surface Alert

After using any of the radiant element positions the ceramic cooktop will become very hot. Even after turning the surface controls off, the cooktop will remain hot for some time after use.

The cooktop control monitors the temperature of the cooktop surface and displays the message **hot surface** when cooktop is still too hot to touch - see fig. 6. If the **hot surface** message remains displayed, the heating zone may be set again and used for cooking.

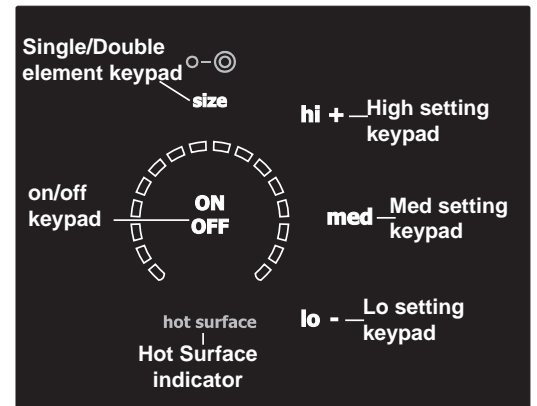
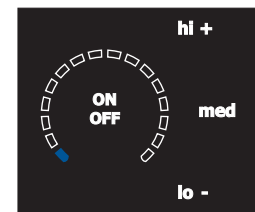
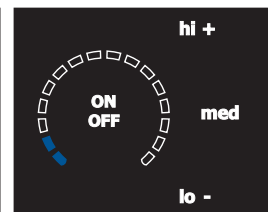

Fig. 1



active

Fig. 2



set for low

Fig. 3

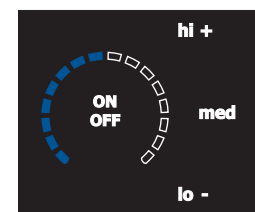

set for medium

Fig. 4

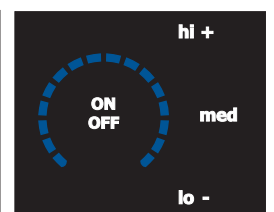

set for high

Fig. 5

CAUTION

Radiant surface elements may appear to have cooled after they have been turned OFF. The Hot Indicator Light will turn ON and will continue to glow until the glass cooktop has cooled down to a moderate level. The glass surface may still be hot and burns may occur if the glass surface is touched before the indicator light has turned OFF.

Do not place plastic items such as salt and pepper shakers, spoon holders or plastic wrappings on top of the range when it is in use. These items could melt or ignite. Potholders, towels or wooden spoons could catch fire if placed too close to the surface elements.

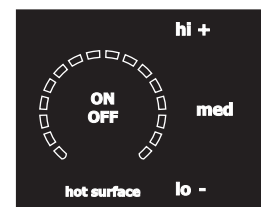

Fig. 6

20 Setting Surface Controls

SETTING THE COOKTOP (CONTINUED)

Setting cooktop elements

- Touch the **ON OFF** key to activate the desired heating zone.
- If the heating zone has more than one element diameter size available, press the desired element ring size symbol.
- Press the desired power level key once (**hi+**, **med** or **lo-**) for quick automatic settings or for more precise level settings use the **hi+** or **lo-** keys. Each press of **hi+** will increase or **lo-** keypad will decrease the power one level at a time. Any of these power level changes or ring changes may be made any time during the heating process.

Suggested cooktop power settings

Use the chart below to determine the suggested setting for the type of food you are preparing and refer to -Fig. 1- to help determine the power level setting when using the control display. The power level areas illustrated are only suggested areas to set the control - Fig. 2. Be sure to monitor your food whenever using the cooktop and adjust as needed for the type of food you are preparing.

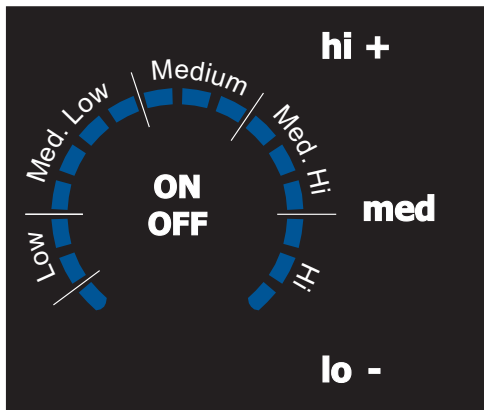

Fig. 1

Recommended Surface Settings Chart	
Setting	Type of Cooking
HIGH (hi)	Start most foods; bring water to boil and pan broiling.
MEDIUM HIGH MEDIUM	Continue a rapid boil; fry, deep fat fry. Maintain a slow boil; thicken sauces, gravies or steam vegetables.
MEDIUM LOW LOW (lo)	Keep foods cooking, poach and stew. Keep warm, melting and simmering.

Notes

- Pressing a cooktop **ON OFF** key only activates or deactivates a surface cooktop zone but will not start the heating process. Activating and powering any surface cooktop zone requires pressing two keys - the **ON OFF** key first and then the power level selection (+, - or **med**) must be added before the cooktop zone will begin heating.
- Any of the cooking zones will begin to heat **ONLY** when activated - See Fig. 2, p 19. If a power level is not added to the active cooking zone within 10 seconds of being active the control will automatically deactivate the cooking zone.
- If activating a surface cooking zone when no surface cooking zones are already active, you will need to press and hold the ON OFF key for a few seconds longer than normal before the first cooking zone will activate. Once any cooking zone is active, any zones added will respond immediately.

Setting the Warmer Oven 21

WARMER OVEN OPERATION

To Operate the Warmer Oven

The purpose of the warmer oven is to keep hot cooked foods at serving temperature. Always start with hot food. **It is not recommended to heat cold food in the warmer drawer.**

All food placed in the warmer oven should be covered with a lid or aluminum foil to maintain moisture and softness. Do not cover crisp foods. **Do not use plastic wrap to cover food. Plastic may melt onto the drawer and be very difficult to clean.**

Use only dishware, utensils and cookware recommended for oven use in the warmer drawer.

Arranging Warmer Oven Rack Positions

Set the warmer oven rack in the vertical position as shown below.

The rack can be used in 2 ways:

- In the **upright position** to allow low profile food items to be placed both under and on top of the rack (for example, rolls or biscuits on top of the rack and a casserole dish under).
- In the **downward position** to allow you to place light weight food items and empty dishware (for example, rolls or pastries and dinner plates).

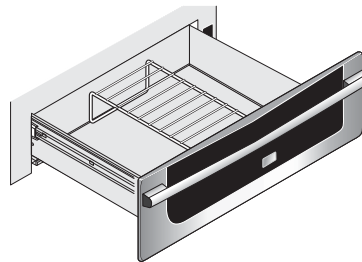



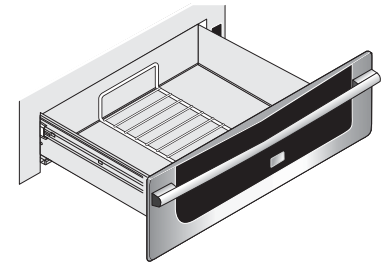

Upright Position



Downward Position

Use the warmer drawer to keep hot foods hot such as: vegetables, gravies, meats, casseroles, biscuits and rolls, pastries and heated dinner plates.

To set a Keep Warm Temperature of 170°F:

1. Arrange interior warmer oven rack.
2. Select oven by pressing **WARMER OVEN** .
3. Press **KEEP WARM** .
4. Press **START** .
5. The Cook Time, Timer and End Time features can be set to control your warming time (read their sections for directions).
6. Remove food. Always use oven mitts when removing hot pans from the oven.
7. Press **CANCEL**  to stop or cancel the Keep Warm feature at any time.

NOTE: The lower oven will not operate when the upper oven is set for self-cleaning or if the control lockout feature is active.

⚠ WARNING KEEP CHILDREN AWAY FROM THE WARMER OVEN WHEN HOT. FAILURE TO DO SO CAN RESULT IN BURNS.

⚠ CAUTION Always use oven mitts when removing food from the lower oven. The lower oven rack, compartment, cookware/plates may be hot.

22 Cooking Modes

BAKING



This mode is best used for your standard recipes. The hidden bake element is used to heat the air and maintain temperature. The upper oven can be programmed to bake at any temperature from 170°F to 550°F with a default temperature of 350°F. The lower oven can be programmed to bake at any temperature from 170°F to 450°F with a default temperature of 350°F.

Upper Oven Baking Tips:

- Always preheat your oven before using the bake mode.
- During preheat, the 3 elements and the convection fan are used in cycle to quickly heat the oven.
- Use only one rack and center the pans as much as possible.
- If using two racks, place the oven racks in positions 3 and 7.
- Allow 2" to 4" (5,1 to 10,2cm) around the utensil(s) for proper air circulation.
- Be sure the pans do not touch each other, the door, sides or back of the oven.



To set a Bake Temperature of 350°F:

1. Arrange interior oven racks.
2. Select oven by pressing **UPPER OVEN** UPPER OVEN.
3. Press **BAKE**
4. Press **START** . The oven display shows **PRE-HEATING**.
5. Place food in the oven when the chime signals and temperature display shows that the oven has reached the set target temperature and the **PRE-HEATING** message disappear.
6. Cook Time, Timer and End Time features can be set to control your cooking time in both ovens (read their sections for directions). The Rapid Preheat features can be used only with the upper oven.
7. Remove food. Always use oven mitts when removing hot pans from the oven.
8. Press **CANCEL**

To change to a Bake Temperature of 425°F:

1. Select oven by pressing **UPPER OVEN** UPPER OVEN or **LOWER OVEN** LOWER OVEN.
2. Press the **HI hi** or **LO lo** pads to get to the desired temperature.

Baking Problems





Refer to the Baking Problems Table in the Solutions to Common Problems section of this manual.

COOK TIME

Cook Time allows the oven to be set to cook for a set length of time and shut off automatically.

The time remaining will always be shown in the timer section of the display. The oven will shut off and will beep when the countdown is finished. This feature can be used with Bake, Convection Bake, Convection Roast, Slow Cook, Keep Warm, Bread Proof and Dehydrate.

To set a timed cooking (example is a 450°F Bake for 30 minutes):







1. Select oven by pressing **UPPER OVEN** .
2. Press **BAKE** . The temperature numbers will blink in the display.
3. Enter temperature needed; **4 5 0**.
4. Press **COOK TIME** .
5. Enter time needed; **3 0**.
6. Press **START** . The oven will start heating. The cook time will start counting down for the set time.
7. Press **CANCEL**  to stop the audible alarm or to cancel cooking at anytime.



END TIME

End Time allows the oven to be set to shut off automatically at a set time of day. The oven control will calculate the remaining time by itself. The time remaining will always be shown in the timer section of the display. The oven will shut off and will beep when the countdown is finished. This feature can be used with Bake, Convection Bake, Convection Roast, Slow Cook, Keep Warm, Dehydrate, Clean and Bread Proof cooking modes. This oven can be programmed with Cook Time and End Time to start and stop by itself at the right time.

To set a delayed timed cooking (example is a 450°F Bake for 30 minutes which will end at 6:00PM):

1. Select oven by pressing **UPPER OVEN** .
2. Press **BAKE** . The temperature numbers will blink in the display.
3. Enter temperature needed; **4 5 0**.
4. Press **COOK TIME** .
5. Enter time needed; **3 0**.
6. Press **END TIME** .
7. Enter time of day needed; **6 0 0**.
8. Press **START** . The time remaining will be shown in the display.
9. Press **CANCEL**  to stop the audible alarm or to cancel cooking at anytime.



CAUTION Use caution with the **COOK TIME** or **END TIME** features. Use the automatic timer when cooking cured or frozen meats and most fruits and vegetables. Foods that can easily spoil such as milk, eggs, fish, meat or poultry, should be chilled in the refrigerator first. Even when chilled, they should not stand in the oven for more than 1 hour before cooking begins, and should be removed promptly when cooking is completed. Eating spoiled food can result in sickness from food poisoning.

24 Cooking Modes

BROILING







This mode is best for meats, fish and poultry up to 1" thick. Broiling is a method of cooking tender cuts of meat by direct heat under the broil element of the oven. The high heat cooks quickly and gives a rich, brown outer appearance. The oven can be programmed to broil at any temperature from 300°F to 550°F with a default temperature of 550°F.

Broiling Tips:

- For optimum browning, preheat the broil element for 2 minutes.
- Broil one side until the food is browned; turn and cook on the second side. Season and serve.
- Always pull the rack out to the "stop" position before turning or removing food.
- Always use the broiler pan and its grid when broiling. It allows the dripping grease to be kept away from the high heat of the broil element (see Figure 1).
- For best broiling results, broil with the oven door slightly open.
- **DO NOT** use the broil pan without the insert. **DO NOT cover the broil pan insert with foil.** The exposed grease could catch fire. **DO NOT** use the roasting rack when broiling.

To set a Broil Temperature of 550°F:

1. Arrange interior oven racks.
2. Select oven by pressing **UPPER OVEN** .
3. Press **BROIL** .
4. Press **START** .
5. Place food in the oven after 2 minutes.
6. Turn food when the top side is browned and cook on the second side.
7. Remove food. Always use oven mitts when removing hot pans from the oven.
8. Press **CANCEL**  to stop or cancel the Broil feature at any time.

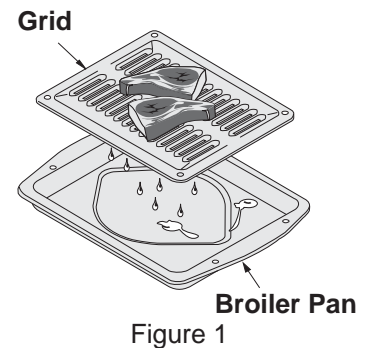

Broiling Times

Electric Wall Oven Broiling Table Recommendations					
Food Item	Rack Position	Temp Setting	Cook Time		Doneness
			1st side	2nd side	
Steak 1» thick	7	550° F	6:00	4:00	Rare
	7	550° F	7:00	5:00	Medium
Pork Chops 3/4» thick	7	550° F	8:00	6:00	Well
Chicken - Bone In	5	450° F	20:00	10:00	Well
Chicken - Boneless	7	450° F	8:00	6:00	Well
Fish	7	500° F	13:00	0:00	Well
Shrimp	5	550° F	5:00	0:00	Well
Hamburger 1» thick	7	550° F	9:00	7:00	Medium
	5	550° F	10:00	8:00	Well

WARNING Should an oven fire occur, close the oven door and turn off the oven. If the fire continues, throw baking soda on the fire or use a fire extinguisher. **DO NOT** put water or flour on the fire. Flour may be explosive and water can cause a grease fire to spread and cause personal injury.

CONVECTION BAKING

This mode of cooking enables you to obtain the best culinary results when baking with multiple pans and racks. Multiple rack baking may slightly increase cook time for some foods but the overall result is time saved. Most foods cooked in a standard oven will cook faster and more evenly with Convection Bake. Convection baking uses the three elements and a fan to circulate the oven's heat evenly and continuously within the oven. The oven can be programmed for Convection baking at any temperature between 170°F to 550°F with a default temperature of 350°F.



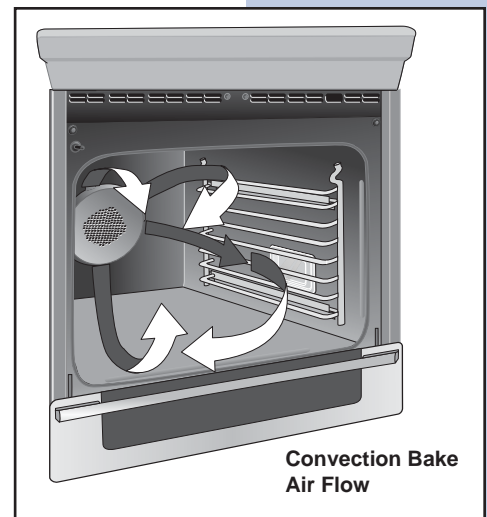

Convection Baking Tips:

- Always preheat your oven before using the Convection Bake mode.
- If your recipe cooking temperature has already been converted for convection baking there is no need to reduce your oven temperature. If your recipe has not had the temperature converted for convection baking you can easily reduce the temperature using the Convection Convert feature. Please see Convection Convert section on next page for further instruction on temperature conversion.
- Use tested recipes with times adjusted for convection baking when using this mode. With single rack convection baking some foods may have as much as a 25% reduction in cook time; check food at minimum time. Time reductions will vary depending on the amount and type of food to be cooked.
- When using Convection Bake with a single rack, place oven rack in position 3 or 4. If cooking on multiple racks, place the oven racks in positions 2 and 6 or 1, 4 and 7.
- Most bakeries (except cakes) should be baked on pans with no sides or very low sides to allow heated air to circulate around the food.
- Food baked on pans with a dark finish will cook faster.







To set a Convection Bake Temperature of 350°F:

1. Arrange interior oven racks.
2. Select oven by pressing **UPPER OVEN** UPPER OVEN.
3. Press **CONVECTION BAKE** .
4. Press **START** . The oven display shows **PRE-HEATING**.
5. Place food in the oven when the chime signals and temperature display shows that the oven has reached the set target temperature and the **PRE-HEATING** message disappear.
6. The Cook Time, Timer, End Time and Rapid Preheat features can be set to control your cooking time (read their sections for directions).
7. Remove food. Always use oven mitts when removing hot pans from the oven.
8. Press **CANCEL**  to stop or cancel the Convection Bake feature at any time.





26 Cooking Modes

CONVECTION CONVERT



The Convection Convert pad is used to automatically convert a standard baking recipe for convection baking. When set properly, this feature is designed to display the actual converted (reduced) temperature in the display. Convection Convert may ONLY be used with a Convection Bake cooking mode. It can be used with the features End Time and Cook Time (see their sections for directions). If convection conversion is used with the cook time and end time features, “CF” (check food) will be displayed when 75% of the bake time is complete. At this time the oven control will sound 3 long beeps at regular intervals until baking had finished. When the bake time has completely finished the control will beep at regular interval until the **CANCEL**  pad is pressed. **NOTE:** To use this feature with the **COOK TIME**  option, the **COOK TIME**  pad must be pressed before the **CONVECTION CONVERT**  pad.

Changing from a normal bake temperature to a convection bake temperature:

1. Select oven by pressing **UPPER OVEN**  UPPER OVEN.
2. Press **CONVECTION BAKE** .
3. Press **CONVECTION CONVERT** . The temperature displayed will be 25°F lower than what it used to be.
4. Press **START**  to begin the convection baking (see Convection Baking section for more informations).





RAPID PREHEAT



The Preheat feature will bring the oven up to temperature faster than a regular preheat and then indicate when to place the food in the oven. Preheating is not necessary when roasting or cooking casseroles. The oven can be programmed to preheat at any temperature between 170°F to 550°F with some of the cooking modes; Bake, Convection Bake and Convection Roast.

IMPORTANT: The rapid preheat feature is for single rack ONLY. The heat distribution with multiple rack will be uneven.

To set a rapid preheat (example is for a 350°F Bake):

1. Select oven by pressing **UPPER OVEN**  UPPER OVEN.
2. Press **BAKE** .
3. Press **RAPID PREHEAT** .
4. Press **START**  to begin the baking with the rapid preheat feature enabled.
5. Place food in the oven when the chime signals and temperature display shows that the oven has reached the set target temperature.

CONVECTION ROASTING

This mode is best for cooking tender cuts of beef, lamb, pork and poultry. Use this mode when cooking speed is desired. The Convection Roasting gently browns the exterior and seals in the juices. Convection roasting uses the hidden bake element, the hidden convection element, the broil element and a fan to circulate the oven's heat evenly and continuously within the oven. The oven can be programmed for Convection Roasting at any temperature between 170°F to 550°F with a default temperature of 350°F.



Convection Roasting Tips:

- Use the broiler pan and grid, and the roasting rack (Figure 1). The broiler pan will catch grease spills and the grid will help prevent spatters. The roasting rack will hold the meat.
- Place an oven rack on rack position 2 (next-bottom).
- Make sure the roasting rack is securely seated on the grid in the broiler pan. The roasting rack fits on the grid allowing the heated air to circulate under the food for even cooking and helps to increase browning on the underside.
- There is no need to reduce the convection temperature or to use the Convection Convert feature with this cooking mode.
- **DO NOT** use the broiler pan without the grid or cover the grid with aluminum foil.
- Always pull the rack out to the stop position before removing food.
- Position food (fat side up) on the roasting rack.

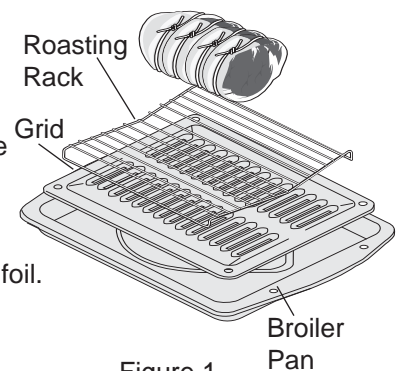





Figure 1

To set a Convection Roast Temperature of 350°F:

1. Arrange interior oven racks.
2. Select oven by pressing **UPPER OVEN** .
3. Press **CONVECTION ROAST** .
4. Press **START** .
5. The Cook Time, Timer, End Time and Rapid Preheat features can be set to control your cooking time (read their sections for directions).
6. Remove food. Always use oven mitts when removing hot pans from the oven.
7. Press **CANCEL**  to stop or cancel the Convection Roast feature at any time.

Convection Roasting Chart					
Meat		Weight	Oven Temp	Internal Temp	Min per lb.
Beef	Standing rib roast	4 to 6 lbs.	350° F	*	25-30
	Rib eye roast	4 to 6 lbs.	350° F	*	25-30
	Tenderloin roast	2 to 3 lbs.	400° F	*	15-25
Poultry	Turkey, whole**	12 to 16 lbs.	325° F	180° F	8-10
	Turkey, whole**	16 to 20 lbs.	325° F	180° F	10-15
	Turkey, whole**	20 to 24 lbs.	325° F	180° F	12-16
	Chicken	3 to 4 lbs.	350-375° F	180° F	12-16
Pork	Ham roast, fresh	4 to 6 lbs.	325° F	160° F	30-40
	Shoulder blade roast	4 to 6 lbs.	325° F	160° F	20-30
	Loin	3 to 4 lbs.	325° F	160° F	20-25
	Pre-cooked ham	5 to 7 lbs.	325° F	160° F	30-40

* For beef: med rare 145°F, med 160°F, well done 170°F

** Stuffed turkey requires additional roasting time. Shield legs and breast with foil to prevent over browning and drying of the skin.

28 Cooking Modes

CONVECTION BROILING



Use this mode for thicker cuts of meat, fish and poultry. The Convection Broiling gently browns the exterior and seals in the juices. Convection broiling uses the broil element and a fan to circulate the oven's heat evenly and continuously within the oven. The oven can be programmed for Convection Broiling at any temperature between 300°F to 550°F with a default temperature of 550°F.

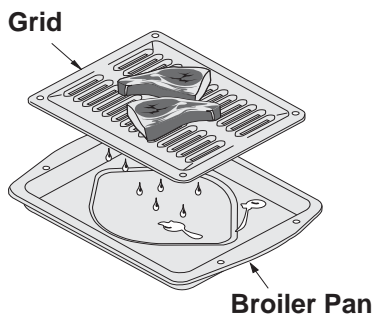





Figure 1

Convection Broiling Tips:

- For optimum browning, preheat the broil element for 2 minutes.
- Broil one side until the food is browned; turn and cook on the second side. Season and serve.
- Always pull the rack out to the «stop» position before turning or removing food.
- Always use the broiler pan and its grid when broiling. It allows the dripping grease to be kept away from the high heat of the broil element (see Figure 1).
- **DO NOT** use the broil pan without the insert. **DO NOT cover the broil pan insert with foil.** The exposed grease could catch fire. **DO NOT** use the roasting rack when broiling.
- Convection broiling is generally faster than conventional broiling. Check for doneness at the minimum recommended time.

IMPORTANT: Always use this cooking mode with the oven door closed or the fan will not turn on.

To set a Convection Broil Temperature of 550°F:

1. Arrange interior oven racks.
2. Select oven by pressing **UPPER OVEN** ^{UPPER} **OVEN**.
3. Press **CONVECTION BROIL** .
4. Press **START** .
5. Place food in the oven after 2 minutes.
6. Turn food when the top side is browned and cook on the second side.
7. Remove food. Always use oven mitts when removing hot pans from the oven.
8. Press **CANCEL**  to stop or cancel the Convection Broil feature at any time.

WARNING Should an oven fire occur, leave the oven door closed and turn off the oven. If the fire continues, throw baking soda on the fire or use a fire extinguisher. **DO NOT** put water or flour on the fire. Flour may be explosive and water can cause a grease fire to spread and cause personal injury.

KEEP WARM

This mode is best for keeping oven baked foods warm for serving after cooking has finished. The Keep Warm feature uses the hidden bake element to maintain the temperature within the oven. The oven can be programmed for Keep Warm at any temperature between 150°F to 190°F with a default temperature of 170°F.



Keep Warm Tips for Upper Oven:

- Always start with hot food.
- Do not use the Keep Warm feature to heat cold food.
- Food in heat-safe glass and glass ceramic containers may need higher temperature settings compared to food in regular containers.
- Avoid repeated openings of the oven, it will allow hot air to escape and the food to cool.
- Aluminum foil may be used to cover food to increase moisture content.

Keep Warm Tips for Lower Oven:

- Follow recommendations for lower oven cooking modes in the **Setting Lower Oven** section of this manual.

To set a Keep Warm Temperature of 170°F:

1. Arrange interior oven racks (for upper oven only).
2. Select oven by pressing **UPPER OVEN** ^{UPPER} **OVEN** or **LOWER OVEN** ^{LOWER} **OVEN**.
3. Press **KEEP WARM**
4. Press **START**
5. The Cook Time, Timer and End Time features can be set to control your warming time (read their sections for directions).
6. Remove food. Always use oven mitts when removing hot pans from the oven.
7. Press **CANCEL**

30 Cooking Modes

SLOW COOK







This mode may be used to cook foods more slowly, at lower oven temperatures and provide cooking results much the same way as a Slow Cooker or Crock-Pot. The Slow Cook feature is ideal for roasting beef, pork & poultry. Slow Cooking meats may result in the exterior of meats becoming dark but not burnt. This is normal. The Slow Cook mode uses the hidden bake element to maintain a low temperature in the oven. There are 2 settings available, high (HI) or low (LO). The maximum cook time for the Slow Cook feature is 12 hours unless the oven control has been changed to the Continuous Bake mode or the Sabbath mode has been activated.

Slow Cook Tips:

- Completely thaw all frozen foods before cooking with the Slow Cook feature.
- When using a single rack, position it in the center of the oven.
- Position multiple racks to accommodate size of cooking utensils when cooking multiple food items.
- Do not open the oven door often or leave the door open when checking foods. If the oven heat escapes often, the Slow Cook time may need to be extended.
- Cover the foods to keep them moist or use a loose or vented type cover to allow foods to turn crisp or brown.
- Cook times will vary; depending on the weight, fat content, bone & the shape of the meat.
- Use the recipe's recommended food temperature and a food thermometer to determine when the food is done.
- Preheating the oven will not be necessary when using the Slow Cook feature.
- Add any cream or cheese sauces during the last hour of cooking.

To set a Slow Cook:

1. Arrange interior oven racks and place food in the oven.
2. Select oven by pressing **UPPER OVEN** .
3. Press **SLOW COOK** .
4. Press **hi** for high (**HI**) setting or **lo** low (**Lo**) setting.
5. Press **START** .
6. The Cook Time, Timer and End Time features can be set to control your Slow Cook time (read their sections for directions).
7. Remove food. Always use oven mitts when removing hot pans from the oven.
8. Press **CANCEL**  to stop or cancel the Slow Cook feature at any time.

DEHYDRATING



This mode dries foods with heat from the bake and the convection element. The heat is circulated throughout the oven by the convection fan. Dehydrating is used to dry and/or preserve foods such as fruits, meats, vegetables and herbs. This mode holds an optimum low temperature while circulating the heated air to slowly remove moisture. The oven can be programmed for Dehydrating at any temperature between 100°F to 225°F with a default temperature of 120°F.



Dehydrating Tips:

- Do not preheat the oven.
- Multiple racks can be used simultaneously.
- Drying times vary depending on the moisture and sugar content of the food, the size of the pieces, the amount being dried and the humidity in the air.
- Check food at the minimum drying time.
- Treat fruits with antioxidants to avoid discoloration.
- Consult a food preservation book or a library for additional information.

To set a Dehydrate Temperature of 120°F:

1. Arrange interior oven racks and place food.
2. Select oven by pressing **UPPER OVEN** UPPER OVEN.
3. Press **DEHYDRATE** .
4. Press **START**  to begin dehydrating.
5. Remove food. Always use oven mitts when removing hot pans from the oven.
6. Press **CANCEL**  to stop or cancel the Dehydrate feature at any time.

32 Cooking Modes

BREAD PROOFING





Proofing bread prepares the dough for baking by activating the yeast. This feature is ideal for proofing, or rising bread dough. The oven can be programmed for Bread Proofing at any temperature between 85°F to 100°F with a default temperature of 100°F. The temperature visual display is not available for this function.

Bread Proofing Tips:

- No need to preheat for this feature.
- Proof bread until dough has doubled in bulk.
- For best results, place a shallow pan with 1 to 3 cups of boiling hot water on the lowest rack position to keep the air moist inside the oven cavity.
- Allow at least 1" between edge of pan and walls of the oven.
- Limit frequent door openings to prevent losing heat and lengthening proofing time.

To set a Bread Proof temperature of 100°F:

1. Arrange interior oven racks and place bread dough in the oven.
2. Select oven by pressing **UPPER OVEN** UPPER OVEN.
3. Press **BREAD PROOF** .
4. Press **START**  to begin the bread proofing.
5. The Cook Time, Timer and End Time features can be set to control your Bread Proof time (read their sections for directions).
6. Remove food.
7. Press **CANCEL**  to stop or cancel the Bread Proof feature at any time.

To change a Bread Proof temperature while the function is active:





1. Select oven by pressing **UPPER OVEN** UPPER OVEN.
2. Press the **HI hi** or **LO lo** pads to get to the desired temperature.
3. Press **START**  to continue the bread proofing with the new setting.

USER PREFERENCES

The User Preferences menu includes all user defined options. This feature enables you to control the various options of the electronic controls. This menu features the Time of Day, Celsius or Fahrenheit display mode, Continuous Bake or 12 Hour Energy Saving modes, Clock display or No-Clock display, 12 Hours Time of Day or 24 Hours Time of Day, Audio Control, and Adjusting the oven temperature. The User Preferences menu is only available when the oven is not being used (not cooking).



To browse through the User Preferences menu:

1. Press **USER PREF**  to bring up the User Preferences menu.
2. Press **USER PREF**  again to browse through the menu pages.
3. Press **hi** or **lo** to toggle between the available options.
4. Press **START**  while the chosen option is on display to change.
5. Press **CANCEL**  when finished to get back to the standard oven display.

User Preferences menu items:



- **CLO 12:00**; Setting the clock.
- **CLO on**; Clock on/off.
- **CLO 12hr**; 12/24 hour time of day display.
- **F-C F**; Fahrenheit / Celsius display.
- **E S on**; 12 hour Energy Saving on/off.
- **Aud**; Audio on/off and volume.
- **UPO**; Adjusting oven temperature.
- **rSt**; Reset to default factory settings.

SETTING THE CLOCK - TIME OF DAY

The clock may be set for 12 or 24 hour time of day operation (see advanced settings section). The clock has been preset at the factory for the 12 hour operation. When the range is first plugged in, or when the power supply to the range has been interrupted, the display will show "**CLO 12:00**". The clock must be set before the oven can be used.

When power to the unit has been interrupted, "**12:00**" appears and flashes in the display. To set the Clock in this case, skip step 1 in the example below and follow steps 2 and 3.

To set the clock (example for 1:30):

1. Press **USER PREF**  until you get to the **CLO 12:00** menu page.
2. Press **1** **3** **0** pads to set the time of day to 1:30. The pads **hi** or **lo** can also be pressed to raise or lower the actual time displayed.
3. Press **START**  to accept the changes and go back to user preferences menu display.

34 Electronic Control Settings



USER PREFERENCES (CONTINUED)



SETTING CLOCK DISPLAY — ON OR OFF

The oven control can be programmed to display the time of day or not. The oven has been preset at the factory to display the time of day.



Changing clock display between ON and OFF:

1. Press **USER PREF**  until you get to the **CLO on** menu page.
-
+
2. Press **lo** or **hi** to toggle between displaying or hiding the clock.
3. Press **START**  to accept the changes and go back to user preferences menu display.

SETTING TIME OF DAY DISPLAY — 12 OR 24 HOURS

The oven control can be programmed to display time of day in 12 hours or 24 hours mode. The oven has been preset at the factory to display in 12 hours mode.



Changing between 12 or 24 hour time of day display:

1. Press **USER PREF**  until you get to the **CLO 12hr** menu page.
-
+
2. Press **lo** or **hi** to toggle the display of the clock in 12 or 24 hours.
3. Press **START**  to accept the changes and go back to user preferences menu display.
4. Remember to set your clock after changing the time of day display mode.

SETTING TEMPERATURE DISPLAY — FAHRENHEIT OR CELSIUS

The oven control can be programmed to display temperatures in Fahrenheit or Celsius. The oven has been preset at the factory to display in Fahrenheit.



To change display from Fahrenheit to Celsius or Celsius to Fahrenheit:

1. Press **USER PREF**  until you get to the **F-C F** menu page.
+
-
2. Press **hi** or **lo** to toggle between the °C and °F display options.
3. Press **START**  to accept the changes and go back to user preferences menu display.

SETTING CONTINUOUS BAKE OR 12 HOUR ENERGY SAVING

The oven control has a factory preset built-in 12 Hour Energy Saving feature that will shut off the oven if the oven control is left on for more than 11 hours and 59 minutes. The oven can be programmed to override this feature for Continuous Baking.

Changing between 12 hour energy saving and continuous bake:



1. Press **USER PREF**  until you get to the **E S** menu page.
+
-
2. Press **hi** or **lo** to toggle the energy saving setting on and off.
3. Press **START**  to accept the changes and go back to user preferences menu display.

USER PREFERENCES (CONTINUED)

AUDIO CONTROL

The Audio Control feature allows the oven control to be operated without sounds or beeps whenever necessary. If desired the control can be programmed for silent operation and later returned to operating with all the default sounds and beeps. The volume of the beeps can also be adjusted.



To change the audio mode or audio volume:

1. Press **USER PREF**  until you get to the **AUd** menu page.
2. Press **hi** or **lo** to toggle between the available volume settings. **AUd 5** for the highest volume setting to **AUd 1** for the lowest volume. **AUd OFF** to disable the beeps.
3. Press **START**  to accept the changes and go back to user preferences menu display.

ADJUSTING OVEN TEMPERATURE

The temperature in the oven has been pre-set at the factory. When first using the oven, be sure to follow recipe times and temperatures. If you think the oven is too hot or too cool, the temperature in the oven can be adjusted. Before adjusting, test a recipe by using a temperature setting that is higher or lower than the recommended temperature. The baking results should help you to decide how much of an adjustment is needed. Each oven can be individually adjusted.



To adjust the oven temperature:

1. Press **USER PREFERENCES**  until you get to the **UPO** menu page.
2. To select the oven you want to adjust, press **USER PREFERENCES**  again to toggle between the upper and the lower display.
3. Enter the temperature by pressing the **hi** or **lo** pads. The temperature can only be adjusted by $\pm 35^{\circ}\text{F}$.
4. Press **START**  to accept the changes and go back to user preferences menu display.

RE-SETTING TO DEFAULT FACTORY SETTINGS

The oven control can be set to return to its original factory settings. This includes: Setting the Clock ON/OFF to ON, Setting the clock display mode to 12h, Display mode to Fahrenheit, Setting the oven temperature adjustment to zero, Setting audio level to 5 and Enabling the 12h energy saving mode. Resetting the control also erase the My Favorite recipes.

To reset the oven control to its original settings:

1. Press **USER PREF**  until you get to the **rSt no** menu page.
2. Press **hi** or **lo** to select **YES**.
3. Press **START**  to reset to default factory settings.



36 Oven Controls





MY FAVORITE



The Favorite setting allows you to save your most frequently used or most complex cooking sequences. This feature will save the cooking mode, the target temperature and the cooktime (if any).



To save a Favorite (example is a 450°F Bake for 30 minutes):

- Saving a Favorite can only be done for an oven which is currently in operation.

1. Select oven by pressing either **UPPER OVEN** .
2. Press **BAKE** . The default temperature will appear in the display.
3. Enter temperature needed; **4 5 0**.
4. Press **COOK TIME** .
5. Enter time needed; **3 0**.
6. Press **START** .
7. Press and hold for 3 seconds **MY FAVORITE**  pad. Notice that the red indicator above the key will light up.

To recall a Favorite:



- Recalling a Favorite can only be done for an oven which is not currently in operation.

1. Select oven by pressing **UPPER OVEN** .
2. Press **MY FAVORITE**  pad which is currently lighted up.
3. Press **START** .

To overwrite a Favorite:

1. To overwrite a My Favorite simply start a new cooking sequence and save it into the same My Favorite for the selected oven as shown in example above. The new My Favorite settings will overwrite the old ones.

To delete a Favorite:



1. Select oven by pressing **UPPER OVEN** .
2. Press the **MY FAVORITE**  pad for **3 seconds**.

SABBATH FEATURE

(FOR USE ON THE JEWISH SABBATH & HOLIDAYS)





The **HI** ⁺hi and **LO** lo pads are used to set the Sabbath feature. The Sabbath feature may only be used with the **BAKE**  pad. The oven temperature may be set higher or lower after setting the Sabbath feature (the oven temperature adjustment feature should be used only during Jewish Holidays), however the display will not visibly show or provide any audible tones indicating whether the change occurred correctly. Once the oven is properly set using Bake with the Sabbath feature active, the oven will remain continuously ON until cancelled. This will override the factory preset 12-Hour Energy Saving feature.

If the oven light will be needed during the Sabbath, press **OVEN LIGHT**  before activating the Sabbath feature. Once the oven light is turned ON and the Sabbath feature is active, the oven light will remain ON until the Sabbath feature is turned OFF. If the oven light needs to be OFF, be sure to turn the oven light OFF before activating the Sabbath feature.

IMPORTANT NOTES: It is not advised to attempt to activate any other program feature other than **BAKE** while the Sabbath feature is active. ONLY the following key pads will function after setting the Sabbath feature; **0** to **9**, **BAKE** , **START** , **CANCEL** , **HI** ⁺hi and **LO** lo.

ALL OTHER KEYPADS will not function once the Sabbath feature is properly activated.

To Program the Upper Oven to Begin Baking Immediately & Activate the Sabbath feature (example: baking at 350°F)



1. Place the food in the oven.
2. Select oven by pressing either **UPPER OVEN** ^{UPPER}OVEN.
3. Press **BAKE** .
4. If you desire to set the oven control for a **COOK TIME**  do so at this time. If not, skip this step and continue to step 5. Refer to their section for complete instructions. Remember the oven will shut down after using **COOK TIME**  and therefore may only be used once during the Sabbath/Jewish Holidays.
5. Press **START** .
6. The oven will turn ON and begin heating immediately.
7. Press and hold both the **HI** ⁺hi and **LO** lo pads for at least 3 seconds. **SAb** will appear in the oven display and **Sb** in the cooktop displays. Once SAb appears in the display the oven control will no longer beep or display any further changes and the oven is properly set for the Sabbath feature.



38 Oven Controls

SABBATH FEATURE (CONTINUED)



Note: You may change the oven temperature once baking has started. Press **UPPER OVEN**, **BAKE** , the numeric key pads for the temperature you want (example for 425°F press **4**, **2**, **5**) and then press **START**  **TWICE** (for Jewish Holidays only). Remember that **the oven control will no longer beep or display any further changes** once the oven is set for the Sabbath feature.

8. The oven may be turned OFF at any time by pressing **CANCEL**  pad (this will turn the oven OFF only). To turn OFF the Sabbath feature press and hold both the **HI hi** and **LO lo** pads for at least 3 seconds. **SAb** will disappear from the display.

Should you experience a power failure or interruption, the oven will shut off. When power is returned the oven will not turn back on automatically. **SF** (Sabbath Failure) will be displayed in the oven control display and the surface element displays. The oven will remember that it is set for the Sabbath and the food may be safely removed from the oven while still in the Sabbath feature, however the oven cannot be turned back on until after the Sabbath.

After the Sabbath observance turn OFF the Sabbath feature. Press and hold both the **HI hi** and **LO lo** pads for at least 3 seconds. **SAb** will disappear from the display and the oven may be used with all normal functions. For further assistance, guidelines for proper usage, and a complete list of models with the Sabbath feature, please visit the web at <http://www.star-k.org>.

Notes for the use of the cooktop in Sabbath mode:

- When the Sabbath feature is enabled on the oven control, it is also enabled on the cooktop. To activate the Sabbath feature, it is not necessary to have one burner ON, but it is necessary to have a Bake function active in the oven.
- When the Sabbath feature is enabled, a surface element can be turned ON by pressing the ON/OFF pad. The element will turn ON 15 to 30 seconds after the ON/OFF pad was pressed. Double elements will turn on with inner element ON only.
- When the Sabbath feature is enabled, the power level of an **active** element can be changed. The change will take effect after a 15 to 30 seconds delay. The element size (inner/outer) CANNOT be changed. Elements will remain with the same size selection they had before entering Sabbath mode.
- All surface element displays will show indicator lights (see Fig. 1).

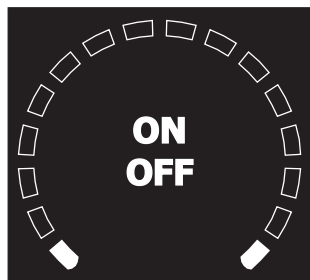



Fig. 1

USING THE SELF-CLEAN FEATURE

Adhere to the Following Cleaning Precautions:

- Allow the oven to cool before cleaning.
- Wear rubber gloves when cleaning any exterior parts of the oven manually.

During the self-cleaning cycle, the outside of the oven can become very hot to the touch. DO NOT leave small children unattended near the appliance.

Before cleaning any part of the oven, be sure the oven is turned off or else push **CANCEL**  pad. Wait until the oven is cool.

DO NOT use commercial oven cleaners or oven protective coatings in or around any part of the self-cleaning oven. DO NOT clean the oven door gasket. The gasket on the oven door is essential for a good seal. Care should be taken not to rub, damage or move the gasket. DO NOT use any cleaning materials on the gasket. Doing so could damage it. DO NOT use aluminum foil to line the oven bottom. This may affect cooking or foil could melt and damage the oven surface.

Preparing the Oven for Self-Cleaning:

1. Remove any excess spillovers in the oven cavity before starting the self-cleaning cycle. To clean, use hot soapy water and a cloth. Large spillovers can cause smoke or a fire when subjected to high temperatures. DO NOT allow food spills with a high sugar or acid content (such as tomatoes, sauerkraut, fruit juices or pie filling) to remain on the surface as they may leave a dull spot even after cleaning.
2. Clean any soil from the oven frame and the door liner (see illustration). These areas heat sufficiently during a self-clean to burn soil on. Clean with hot soapy water.
3. Remove the broiler pan and insert, all utensils and any foil. These items can not withstand high cleaning temperatures.
4. Oven racks and oven rack supports must be removed. If they are not removed the self-cleaning cycle can not start and Remove Racks will appear in the display indicating that you must remove the racks and racks supports. When the cycle has finished and the door can be opened replace the oven rack supports and oven racks.

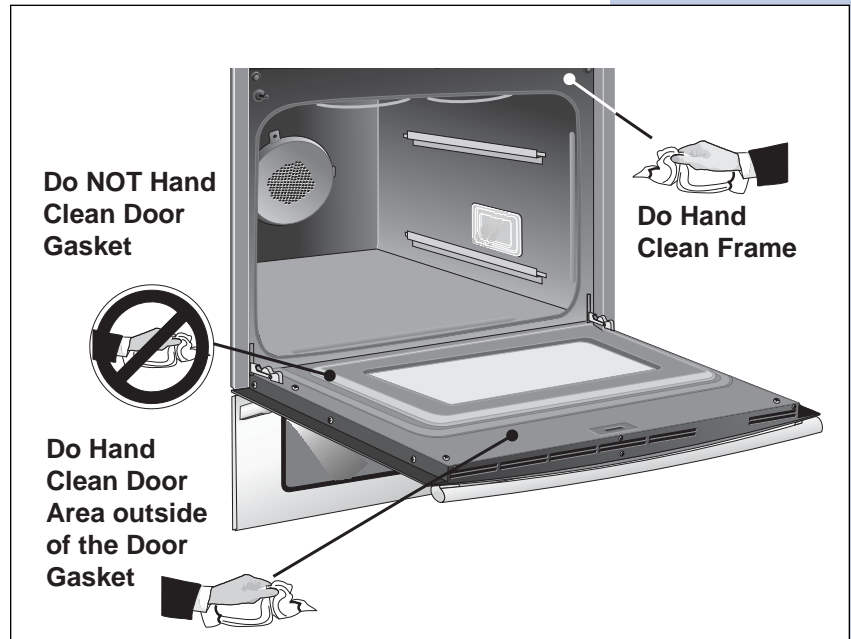

CAUTION The health of some birds is extremely sensitive to the fumes given off during the self-clean cycle of any wall oven. Move birds to another well ventilated room.







40 Care & Cleaning

STARTING SELF-CLEAN CYCLE





A self-cleaning oven cleans itself with high temperatures (well above cooking temperatures) which eliminate soil completely or reduce it to a fine powdered ash you can whisk away with damp cloth. If you are planning to use the oven directly after a self-clean cycle remember to allow time for the oven to cool down and the oven door to unlock. This normally takes about one hour.

To set the controls for a Self-Cleaning cycle:



1. Remove the oven racks, the racks supports and press **UPPER OVEN** ^{UPPER} **OVEN**.
2. Press **clean** ^{lite}  for a 2 hours self-clean, **clean** ^{med}  for 3 hours, or press **clean** ^{heavy}  for 4 hours cleaning cycle.
3. Press **START** . The "DOOR  " icon will flash.
4. As soon as the control is set, the motor driven oven door lock will begin to close automatically. Once the door has been locked the "DOOR  " indicator light will stop flashing and remain on.

Note: Allow about 15 seconds for the oven door lock to close.

To set the controls for a delayed Self-Cleaning cycle:



1. Follow the instructions above.
2. Press **END TIME** .
3. Enter time of day needed for the end of the cycle (example for "6:00"; **6** **0** **0**).
4. Press **START** .

When the Self-Clean Cycle is Completed:

1. The time of day and "DOOR  " will remain ON.
2. The display will show an "Hot" message while the oven is still too hot to open door.
3. Once the oven has cooled down for 1 HOUR, and the "DOOR  " icon is no longer displayed, the oven door can then be opened.

Stopping or Interrupting a Self-Cleaning Cycle:

If it becomes necessary to stop or interrupt a self-cleaning cycle due to excessive smoke:

1. Press **CANCEL** .
2. Once the oven has cooled down for approximately 1 HOUR and the "DOOR  " icon is no longer displayed, the oven door can then be opened.

⚠ WARNING During the self-cleaning cycle, the outside of the wall oven can become very hot to the touch. **DO NOT** leave small children unattended near the appliance; they may be burned if they touch the hot oven door surfaces.

⚠ CAUTION **DO NOT** force the oven door open. This can damage the automatic door locking system. Use care when opening the oven door after the self-cleaning cycle. Stand to the side of the oven when opening the door to allow hot air or steam to escape. The oven may still be VERY HOT.

GENERAL CLEANING

Cleaning Various Parts of Your appliance

Before cleaning any part of the appliance, be sure all controls are turned OFF and the appliance is COOL. REMOVE SPILLOVERS AND HEAVY SOILING AS SOON AS POSSIBLE. REGULAR CLEANINGS WILL REDUCE THE NUMBER OF MAJOR CLEANINGS LATER.

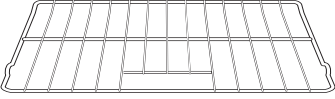
Surfaces	How to Clean
Glass, Painted and Plastic Body Parts and Decorative Trim	<i>For general cleaning</i> , use hot, soapy water and a cloth. <i>For more difficult soils and built-up grease</i> , apply a liquid detergent directly onto the soil. Leave on soil for 30 to 60 minutes. Rinse with a damp cloth and dry. DO NOT use abrasive cleaners on any of these materials; they can scratch.
Control Panel	<i>Before cleaning the control panel</i> , turn all controls to OFF. Lightly spray the control panel with a liquid cleaner. Wipe with a soft cloth or paper towel. DO NOT use abrasive cleaners or scouring pads. These can permanently damage the control panel surface.
Porcelain Enamel Broiler Pan and Grid	Gentle scouring with a soapy scouring pad will remove most spots. Rinse with a 1:1 solution of clear water and ammonia. <i>If necessary</i> , cover difficult spots with an ammonia-soaked paper towel for 30 to 40 minutes. Rinse with clean water and a damp cloth, and then scrub with a soap-filled scouring pad. Rinse and wipe dry with a clean cloth. Remove all cleaners or the porcelain may become damaged during future heating.
Stainless Steel, Chrome Decorative Trim, Oven Racks, Oven Racks Support	Clean with hot, soapy water and a dishcloth. Rinse with clean water and a cloth. Cover stubborn spots with an ammonia-soaked paper towel for 30 to 40 minutes. Rinse. Cleaners made especially for stainless steel are recommended. Be sure to rinse the cleaners as bluish stains may occur during heating and cannot be removed.
Oven Racks 	Oven racks and oven rack supports must be removed from the oven during the self-clean cycle for cleaning. If they are not removed, the self-clean cycle will not start. Clean them as described above.
Oven Door	To clean oven door, wash with hot, soapy water and a clean cloth. DO NOT immerse the door in water or clean the oven door gasket.
Oven Door Gasket	The oven gasket located on the inner frame of the door and visible when the door is opened is essential for a good seal. Care should be taken not to rub, damage or remove the gasket.
Lower Oven	To remove burned-on fat on oven walls, moisten soiled parts with household ammonia, using a wet cloth. Complete cleaning with a damp cloth and use a fine steel wool scouring agent if necessary.

42 Care & Cleaning

CARE AND CLEANING OF STAINLESS STEEL

Special care and cleaning are **required** for maintaining the appearance of stainless parts. Please refer to the table provided at the beginning of the **General Care & Cleaning** section in this Use & Care Manual.

TO REMOVE AND REPLACE OVEN DOOR

1. Open the door to the fully opened position.
2. Pull up the lock located on each hinge support toward front of range. You may have to apply a little upward pressure on the lock to pull it up.
3. Grasp the door by the sides, pull the bottom of the door up and toward you to disengage the hinge supports.
Keep pulling the bottom of the door toward you while rotating the top of the door toward the appliance to completely disengage the hinge levers.
4. Proceed in reverse to re-install the door. Make sure the hinge supports are fully engaged before unlocking the hinge levers.

Removal of the Oven Door

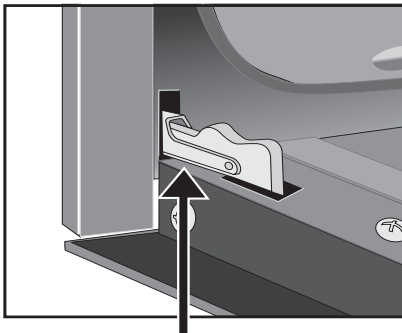

Lock in normal position

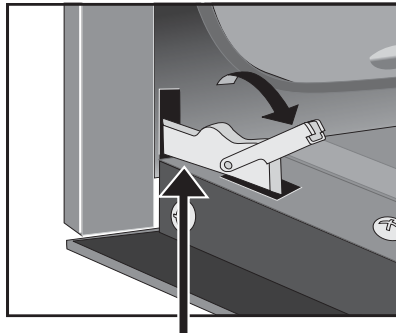

Lock engaged for door removal

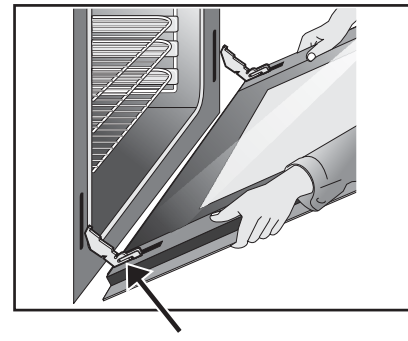

HINGE SLOT - Door removed from the appliance

SPECIAL DOOR CARE INSTRUCTIONS

Most oven doors contain glass that can break.

Read the following recommendations:

1. Do not close the oven door until all the oven racks are fully in place.
2. Do not hit the glass with pots, pans, or any other object.
3. Scratching, hitting, jarring or stressing the glass may weaken its structure causing an increased risk of breakage at a later time.

OVEN LIGHT

An interior oven light will turn on automatically when the oven door is opened. The oven light may be turned on when the door is closed by using the oven light switch located on the control panel.

The lamp is covered with a glass shield. The glass shield can be removed to be cleaned manually or to change the oven light.

THIS GLASS SHIELD MUST BE IN PLACE WHENEVER THE OVEN IS IN USE.

To replace the light bulb:

CAUTION: BE SURE THE OVEN IS COOL.

1. Turn the power off at the main source.
2. Wear a leather-faced glove for protection against possible broken glass.
3. To remove the glass shield, pull the back side of the shield toward the inside of the oven in a manner to lift it up from the oven side.
4. The glass shield should come out easily by pushing a little toward front of the wall oven.
5. Replace halogen light appliance bulb taking care to not touch the bulb. Touching the halogen bulb with bare fingers can damage it and also burn it.
6. To replace glass shield, proceed in reverse.

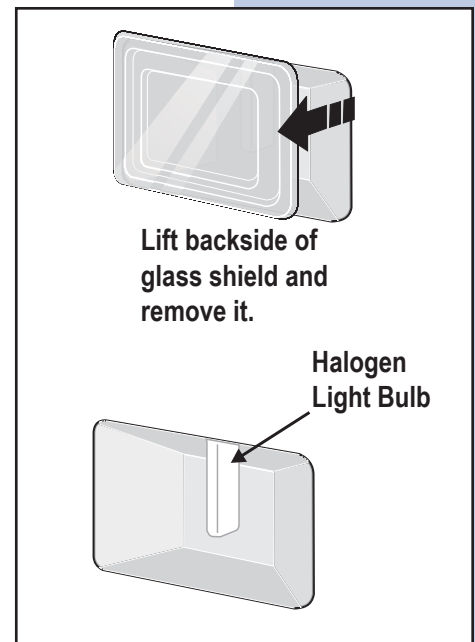

BROILER PAN CLEANING TIPS

To make cleaning easier, line the bottom of the broiler pan with aluminum foil. **DO NOT** cover the broiler grid with foil.

To prevent grease from baking on, remove the broiler pan from the oven as soon as cooking is completed. Use hot pads because the broiler pan is extremely hot. Pour off grease. Soak the pan in **HOT**, soapy water.

Clean the broiler pan as soon as possible after each use. If necessary, use soap-filled steel wool pads. Heavy scouring may scratch the grid.

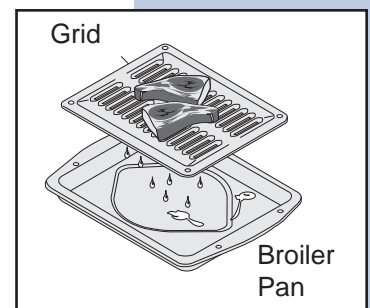

44 General Care & Cleaning

COOKTOP CLEANING AND MAINTENANCE

Consistent and proper cleaning is essential to maintaining your ceramic glass cooktop

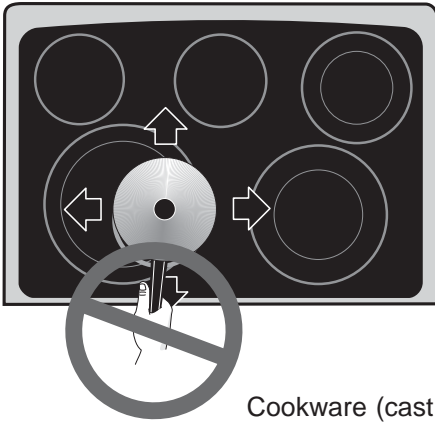

Prior to using your cooktop for the first time, apply the recommended Cleaning Creme to the ceramic surface. A sample of that cleaning creme is supplied with your cooktop and it is available in most hardware stores. Clean and buff with a paper towel. This will make cleaning easier when soiled from cooking. The special cooktop cleaning cream leaves a protective finish on the glass to help prevent scratches and abrasions.

Sliding aluminum or copper clad bottom pans on the cooktop can cause metal markings on the cooktop surface. These marks should be removed **immediately** after the cooktop has cooled using the cooktop cleaning cream. Metal marks can become permanent if not removed prior to future use.

Cookware (cast iron, metal, ceramic or glass) with rough bottoms can mark or scratch the cooktop surface. **Do not slide anything metal or glass** across the cooktop. **Do not** use your cooktop as a cutting board or work surface in the kitchen. **Do not** cook foods directly on the cooktop surface without a pan. **Do not** drop heavy or hard objects on the glass cooktop, they may cause it to crack or break.

CLEANING RECOMMENDATIONS FOR THE CERAMIC GLASS COOKTOP

⚠ CAUTION

Before cleaning the cooktop, be sure the controls are turned to OFF and the cooktop is COOL.

⚠ WARNING

DO NOT use a cooktop cleaner on a hot cooktop. The fumes can be hazardous to your health, and can chemically damage the ceramic-glass surface.

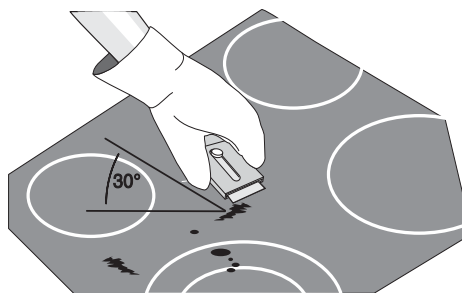

For light to moderate soil:

Apply a few drops of CookTop® Cleaning Creme directly to the cooktop. Use a paper towel to clean the entire cooktop surface. Make sure the cooktop is cleaned thoroughly, leaving no residue. Do not use the towel you use to clean the cooktop for any other purpose.

For heavy, burned on soil:

First, clean the surface as described above. Then, if soils remain, carefully scrape soils with a metal razor blade scraper, holding scraper at a 30 degree angle to the surface. Remove loosened soils with cooktop cleaning cream and buff surface clean.

CLEANING RECOMMENDATIONS FOR THE CERAMIC GLASS COOKTOP (CONTINUED)

CAUTION

Damage to the ceramic glass cooktop may occur if you use scrub pad.

Plastic or foods with a high sugar content:

These types of soils must be removed immediately if spilled or melted onto the ceramic cooktop surface. Permanent damage (such as pitting of the cooktop surface) may occur if not removed **immediately**. After turning the surface elements OFF, use a razor blade scraper or a metal spatula with a mitt and scrape the soil from the hot surface (as illustrated on previous page). Allow the cooktop to cool, and use the same method for heavy or burned on soils.

Do not use the following on the ceramic glass cooktop:

- Do not use abrasive cleaners and scouring pads, such as metal and some nylon pads. They may scratch the cooktop, making it more difficult to clean.
- Do not use harsh cleaners, such as chlorine bleach, ammonia or oven cleaners, as they may etch or discolor the cooktop.
- Do not use dirty sponges, cloths or paper towels, as they can leave soil or lint on the cooktop which can burn and cause discoloration.







Special Caution for Aluminum Foil and Aluminum Cooking Utensils

- **Aluminum foil** - Use of aluminum foil will damage the cooktop. Do not use thin aluminum cooking utensils or allow foil to touch the ceramic cooktop under ANY circumstances.
- **Aluminum utensils** - The melting point of aluminum is much lower than that of other metals. Care must be taken when aluminum pots or pans are used on the cooktop. If allowed to boil dry, not only will the utensil be destroyed, but it may fuse to, break or mark the ceramic glass surface, permanently damaging the cooktop surface.

Baking Problems

For best cooking results pre-heat the oven when baking cookies, breads, cakes, pies or pastries, etc. There is no need to preheat the oven for roasting meats or baking casseroles. The cooking times and temperatures needed to bake a product may vary slightly from your previous appliance.

Baking Problems and Solutions Chart

Baking Problems	Causes	Solutions
<p>Cookies and biscuits burn on the bottom.</p> 	<ul style="list-style-type: none"> • Cookies and biscuits put into the oven before the preheating time is completed. • Oven rack overcrowded or rack position too low. • Dark pan absorbs heat too fast. 	<ul style="list-style-type: none"> • Allow oven to preheat to the selected temperature before placing food in oven. • Choose pan sizes that will permit 5.1cm to 10.2cm (2" to 4") of air space on all sides when placed in the oven. • Use a medium-weight aluminum baking sheet.
<p>Cakes too dark on top or bottom.</p> 	<ul style="list-style-type: none"> • Cakes put into the oven before preheating time is completed. • Rack position too high or low. • Oven too hot. 	<ul style="list-style-type: none"> • Allow oven to preheat to the selected temperature before placing food in the oven. • Use proper rack position for baking needs. • Set oven temperature 25°F/12°C lower than recommended.
<p>Cakes not done in the center.</p> 	<ul style="list-style-type: none"> • Oven too hot. • Incorrect pan size. • Pan not centered in oven. 	<ul style="list-style-type: none"> • Set oven temperature 25°F/12°C lower than recommended. • Use pan size suggested in recipe. • Use proper rack position and place pan so there is 5.1cm to 10.2cm (2" to 4") of space on all sides of pan.
<p>Cakes not level.</p> 	<ul style="list-style-type: none"> • Range not level. • Pan too close to oven wall or rack overcrowded. • Pan warped. 	<ul style="list-style-type: none"> • Place a marked glass measuring cup filled with water on the center of the oven rack. If the water level is uneven, refer to the installation instructions for leveling the range. • Be sure to allow 5.1cm to 10.2cm (2" to 4") of clearance on all sides of each pan in the oven. • Do not use pans that are dented or warped.
<p>Foods not done when cooking time is up.</p> 	<ul style="list-style-type: none"> • Oven too cool. • Oven overcrowded. • Oven door opened too frequently. 	<ul style="list-style-type: none"> • Set oven temperature 25°F/12°C higher than suggested and bake for the recommended time. • Be sure to remove all pans from the oven except the ones to be used for baking. • Open oven door only after shortest recommended baking time.

IMPORTANT

Before calling for service, review this list. It may save you both time and expense. This list includes common experiences that are not the result of defective workmanship or material in your cooktop.

OVEN CONTROL BEEPS AND DISPLAYS AN “F” ERROR CODE

- Electronic control has detected a fault condition. Push **CANCEL pad** to clear the display and stop the display from beeping. Reprogram the oven. If a fault reoccurs, record the fault number, push the **CANCEL pad** and contact an authorized servicer.

INSTALLATION

- Place oven rack in center of oven. Place a level on the oven rack. Contact installing agent if rack and cabinet cutout flooring are not level.
- Kitchen cabinet misalignment may make range appear to be not level. Be sure cabinets are square and level. Contact cabinet maker to correct problem.

ENTIRE RANGE DOES NOT OPERATE

- When the range is first plugged in, or when the power supply to the oven has been interrupted, the display will flash. The range cannot be programmed until the clock is set.
- Be sure electrical cord is securely connected into the electrical junction box.
- Cord/plug is not installed and/or connected. Cord is not supplied with range. Contact your dealer, installing agent or authorized servicer.
- Service wiring not complete. Contact your dealer, installing agent or authorized servicer.
- Power outage. Check house lights to be sure. Call your local electric company.
- Short in cord/plug. Replace cord/plug.
- Controls are not set properly. See instructions to set the controls.
- House fuse has blown or circuit breaker has tripped immediately following installation.
- House fuse may not be fully engaged. Check fuse and screw or engage circuit breaker securely.

OVEN LIGHT DOES NOT WORK

- Burned-out or loose bulb. Follow the instructions under **Oven Light** to replace or tighten the bulb.

48 Solutions to Common Problems

SELF-CLEANING CYCLE DOES NOT WORK

- Make sure the oven door is closed.
- Make sure you have removed the oven racks and the oven rack supports from the oven.
- Controls not set properly. Follow instructions under “Using the Self-Clean Feature”.

OVEN SMOKES EXCESSIVELY DURING BROILING

- Meat too close to the broiler element. Reposition the rack to provide more clearance between the meat and the broiler. Preheat broil element for quick searing operation.
- Meat not properly prepared. Remove excess fat from meat. Cut remaining fatty edges to prevent curling, but do not cut into the lean.
- Grid on broiler pan wrong side-up. Grease does not drain into broiler pan. Always place the grid on the broiler pan with the ribs up and the slots down to allow grease to drip into the pan.
- Broiler pan used without grid or grid cover with aluminum foil. **DO NOT** use the broiler pan without the grid or cover the grid with aluminum foil.
- Oven needs to be cleaned. Grease has built up on oven surfaces. Regular cleaning is necessary when broiling frequently. Grease or food spatters cause excessive smoking.

SOIL NOT COMPLETELY REMOVED AFTER SELF-CLEANING CYCLE IS COMPLETED

- Failure to clean bottom, from top of oven, frame of oven or door area outside oven seal. These areas are not in the self-cleaning area, but get hot enough to burn on residue. Clean these areas before the self-cleaning cycle is started. Burned on residue can be cleaned with a stiff nylon brush and water or a nylon scrubber. Be careful not to damage the oven gasket.
- Excessive spillovers in oven. Set the self-clean cycle for longer cleaning time.

POOR COOKING RESULTS

- Many factors affect baking results. See **Baking** for hints, causes and corrections. See **Adjusting Oven Temperature**.
- Many factors affect cooking results. Adjust the recipe’s recommended power levels or cooking times.
- Cookware is too lightweight or warped. Use heavier quality cookware so foods being prepared may cook more evenly.

FLAMES INSIDE OVEN OR SMOKE FROM VENT

- Excessive spillovers in oven. This is normal, especially for high oven temperatures, pie spillovers or for large amounts of grease on bottom of oven. Wipe up excessive spillovers.

SURFACE ELEMENT DOES NOT HEAT

- No power to appliance. Check/reset breaker or replace fuse. If the problem is a circuit overload, or improper connection of the armored cable supplied with the appliance, have this situation corrected by a qualified electrician.
- Too low heat setting. Turn control to a slightly higher setting until element comes on.
- Incorrect control is ON. Be sure to use correct control for the element needed.

SURFACE ELEMENT TOO HOT OR NOT HOT ENOUGH

- Incorrect control setting. Raise or lower setting until proper amount of heat is obtained. Dial markings are an indicator of relative heat settings and will vary slightly.
- Lightweight or warped pans being used. Use only flat, evenly balanced, medium or heavyweight cookware.
- Voltage is incorrect. Be sure appliance is properly connected to the specified power source.
- Use only flat bottom, evenly balanced, medium or heavyweight cookware. Pans having a flat bottom heat better than warped pans. Cookware material affects heating. Heavy and medium weight pans heat evenly. Because lightweight pans heat unevenly, foods may burn easily.

FOOD NOT HEATING EVENLY

- Improper cookware. Select flat-bottomed cookware of a proper size to fit element.
- Incorrect control setting. Raise or lower setting until proper amount of heat is obtained.

SCRATCHES OR ABRASIONS ON CERAMIC GLASS COOKTOP SURFACE

- Coarse particles (such as salt or sand) are between cooktop and utensil. Be sure cooktop surface and bottom of utensils are clean before use. Small scratches do not affect cooking and will become less visible with use.
- Cleaning materials not recommended for glass ceramic cooktop have been used. See **Ceramic-Glass Cooktop** section in this Owner's Guide.
- Cookware with rough bottom has been used. Use flat-bottomed, smooth utensils. See Selecting **Surface Cooking Utensils** in this Owner's Guide.

50 Solutions to Common Problems

BROWN STREAKS AND SPECKS ON CERAMIC GLASS COOKTOP SURFACE

- Boilovers have cooked onto surface. Use razor blade scraper to remove soil. See instructions under **General Care & Cleaning**.
- Cleaning materials not recommended for ceramic-glass cooktop have been used. Use recommended cleaners and cleaning method. See **Ceramic-Glass Cooktop** section in this Owner's Guide.

AREAS OF DISCOLORATION ON CERAMIC GLASS COOKTOP SURFACE

- Mineral deposits from water and food. Wet surface with water and sprinkle on a cooktop cleaning creme. Scrub with a clean damp paper towel until the stain disappears. Wipe remaining paste away, then apply a small amount of cooktop cleaning creme and polish with a clean paper towel. Use cookware with clean, dry bottoms. See **Ceramic-Glass Cooktop** section in this Owner's Guide.

METAL MARKS ON CERAMIC GLASS COOKTOP SURFACE

- Sliding or scraping of metal utensils on cooktop surface. Do not slide metal utensils on cooktop surface. Use a mildly abrasive cleanser to remove marks.

Warranty Information 51

Your appliance is covered by a one year limited warranty. For one year from your original date of purchase, Electrolux will repair or replace any parts of this appliance that prove to be defective in materials or workmanship when such appliance is installed, used, and maintained in accordance with the provided instructions. In addition, the glass cooktop or radiant surface element of your appliance (excluding built-in and free-standing range appliances) is covered by a two through five year limited warranty. During the 2nd through 5th years from your original date of purchase, Electrolux will provide a replacement glass cooktop or radiant surface element for your appliance which has proven to be defective in materials or workmanship when such appliance is installed, used, and maintained in accordance with the provided instructions.

Exclusions

This warranty does not cover the following:

1. Products with original serial numbers that have been removed, altered or cannot be readily determined.
2. Product that has been transferred from its original owner to another party or removed outside the USA or Canada.
3. Rust on the interior or exterior of the unit.
4. Products purchased "as-is" are not covered by this warranty.
5. Food loss due to any refrigerator or freezer failures.
6. Products used in a commercial setting.
7. Service calls which do not involve malfunction or defects in materials or workmanship, or for appliances not in ordinary household use or used other than in accordance with the provided instructions.
8. Service calls to correct the installation of your appliance or to instruct you how to use your appliance.
9. Expenses for making the appliance accessible for servicing, such as removal of trim, cupboards, shelves, etc., which are not a part of the appliance when it is shipped from the factory.
10. Service calls to repair or replace appliance light bulbs, air filters, water filters, other consumables, or knobs, handles, or other cosmetic parts.
11. Labor or in-home service costs during the additional limited warranty periods beyond the first year from your original date of purchase.
12. Pickup and delivery costs; your appliance is designed to be repaired in the home.
13. Surcharges including, but not limited to, any after hour, weekend, or holiday service calls, tolls, ferry trip charges, or mileage expense for service calls to remote areas, including the state of Alaska.
14. Damages to the finish of appliance or home incurred during transportation or installation, including but not limited to floors, cabinets, walls, etc.
15. Damages caused by: services performed by unauthorized service companies; use of parts other than genuine Electrolux parts or parts obtained from persons other than authorized service companies; or external causes such as abuse, misuse, inadequate power supply, accidents, fires, or acts of God.

DISCLAIMER OF IMPLIED WARRANTIES; LIMITATION OF REMEDIES

CUSTOMER'S SOLE AND EXCLUSIVE REMEDY UNDER THIS LIMITED WARRANTY SHALL BE REPAIR OR REPLACEMENT AS PROVIDED HEREIN. **CLAIMS BASED ON IMPLIED WARRANTIES, INCLUDING WARRANTIES OF MERCHANTABILITY OR FITNESS FOR A PARTICULAR PURPOSE, ARE LIMITED TO ONE YEAR OR THE SHORTEST PERIOD ALLOWED BY LAW, BUT NOT LESS THAN ONE YEAR.** ELECTROLUX SHALL NOT BE LIABLE FOR CONSEQUENTIAL OR INCIDENTAL DAMAGES SUCH AS PROPERTY DAMAGE AND INCIDENTAL EXPENSES RESULTING FROM ANY BREACH OF THIS WRITTEN LIMITED WARRANTY OR ANY IMPLIED WARRANTY. SOME STATES AND PROVINCES DO NOT ALLOW THE EXCLUSION OR LIMITATION OF INCIDENTAL OR CONSEQUENTIAL DAMAGES, OR LIMITATIONS ON THE DURATION OF IMPLIED WARRANTIES, SO THESE LIMITATIONS OR EXCLUSIONS MAY NOT APPLY TO YOU. THIS WRITTEN WARRANTY GIVES YOU SPECIFIC LEGAL RIGHTS. YOU MAY ALSO HAVE OTHER RIGHTS THAT VARY FROM STATE TO STATE.

If You Need Service

Keep your receipt, delivery slip, or some other appropriate payment record to establish the warranty period should service be required. If service is performed, it is in your best interest to obtain and keep all receipts. Service under this warranty must be obtained by contacting Electrolux at the addresses or phone numbers below.

This warranty only applies in the USA, Puerto Rico and Canada. In the USA and Puerto Rico, your appliance is warranted by Electrolux Major Appliances North America, a division of Electrolux Home Products, Inc. In Canada, your appliance is warranted by Electrolux Canada Corp. Electrolux authorizes no person to change or add to any obligations under this warranty. Obligations for service and parts under this warranty must be performed by Electrolux or an authorized service company. Product features or specifications as described or illustrated are subject to change without notice.

USA

1-877-435-3287

Electrolux Major Appliances North America
P.O. Box 212378
Augusta, GA 30907

Canada

1-800-265-8352

Electrolux Canada Corp.
5855 Terry Fox Way
Mississauga, Ontario, Canada L5V 3E4

 **Electrolux**
