

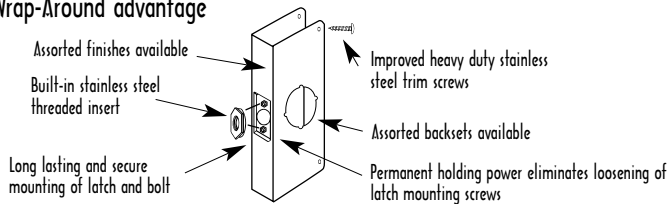

CLASSIC WRAP-AROUNDS

The Classic Wrap-Around advantage includes:



- Finishes Available:
 605= Polished Brass
 609= Antique Brass
 612= Satin Bronze
 613= Oil Rubbed Bronze
 630= Stainless Steel

Note: Security Strikes are recommended with these products. See Pages 51,52 for ordering instructions.

For **CYLINDRICAL DOOR LOCKS** with 2 1/8" hole

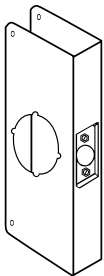

- 1-CW**
2-CW
3-CW
4-CW

NUMBER	BACKSET	DOOR	DIMENSIONS
1-CW	2 3/8"	1 3/8"	4" x 9"
2-CW	2 3/8"	1 3/4"	4" x 9"
3-CW	2 3/4"	1 3/8"	4 1/4" x 9"
4-CW	2 3/4"	1 3/4"	4 1/4" x 9"

SHELF PACK: 1

FINISHES: PB (605), AB (609), BZ (612), IOB (613), S (630)

22 (.032) Gauge

Box Size - 4 1/2" x 9 3/4"

CW comes box packaged as standard.

Display Packaged also available. When ordering indicate by replacing the letters "CW" with "V" after the item number.

Display Package Size - 5 1/4" x 11"

For **DEADBOLTS** with 1 1/2" hole

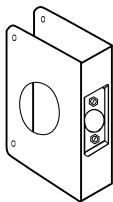

- 5-CW**
6-CW
7-CW
8-CW

NUMBER	BACKSET	DOOR	DIMENSIONS
5-CW	2 3/8"	1 3/8"	4" x 4 1/2"
6-CW	2 3/8"	1 3/4"	4" x 4 1/2"
7-CW	2 3/4"	1 3/8"	4 1/4" x 4 1/2"
8-CW	2 3/4"	1 3/4"	4 1/4" x 4 1/2"

SHELF PACK: 1

FINISHES: PB (605), AB (609), BZ (612), IOB (613), S (630)

22 (.032) Gauge

Box Size - 5 1/4" x 4 1/2"

CW comes box packaged as standard.

Display Packaged also available. When ordering indicate by replacing the letters "CW" with "V" after the item number.

Display Package Size - 5 1/4" x 6 1/2"

For **CYLINDRICAL DOOR LOCKS** with 2 1/8" hole

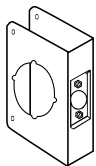

- 51-CW**
61-CW
71-CW
81-CW

NUMBER	BACKSET	DOOR	DIMENSIONS
51-CW	2 3/8"	1 3/8"	4" x 4 1/2"
61-CW	2 3/8"	1 3/4"	4" x 4 1/2"
71-CW	2 3/4"	1 3/8"	4 1/4" x 4 1/2"
81-CW	2 3/4"	1 3/4"	4 1/4" x 4 1/2"

SHELF PACK: 1

FINISHES: PB (605), AB (609), BZ (612), IOB (613), S (630)

22 (.032) Gauge

Box Size - 5 1/4" x 4 1/2"

CW comes box packaged as standard.

Display Packaged also available. When ordering indicate by replacing the letters "CW" with "V" after the item number.

Display Package Size - 5 1/4" x 6 1/2"



For DOUBLE LOCK COMBINATION LOCKSETS with 1 1/2" hole on top and 2 1/8" hole on bottom with 4" centers

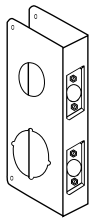

**154-CW
264-CW
484-CW**

NUMBER	BACKSET	DOOR	DIMENSIONS
154-CW	2 3/8"	1 3/8"	4" x 9"
264-CW	2 3/8"	1 3/4"	4" x 9"
484-CW	2 3/4"	1 3/4"	4 1/4" x 9"

Display Packaged also available. When ordering indicate by replacing the letters "CW" with "V" after the item number.

Display Package Size - 5 1/4" x 11"

SHELF PACK: I

FINISHES: PB (605), AB (609), BZ (612), IOB (613), S (630)

22 (.032) Gauge

Box Size - 4 1/2" x 9 3/4"

CW comes box packaged as standard.

For DOUBLE LOCK COMBINATION LOCKSETS with 2 1/8" holes with 5 1/2" centers

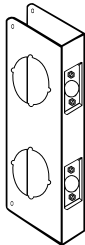

**256-CW
258-CW**

NUMBER	BACKSET	DOOR	DIMENSIONS
256-CW	2 3/8"	1 3/4"	4" x 12"
258-CW	2 3/4"	1 3/4"	4 1/4" x 12"

SHELF PACK: I

FINISHES: PB (605), AB (609), BZ (612), IOB (613), S (630)

22 (.032) Gauge

Box Packed Only

For CYLINDER DOOR LOCKS with 2 1/8" hole, 12" height

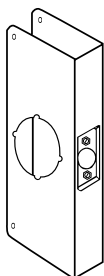

12-CW

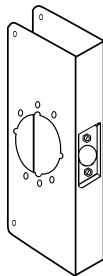

12-2-CW

NUMBER	BACKSET	DOOR	DIMENSIONS
12-CW	2 3/4"	1 3/4"	4 1/4" x 12"
12-2-CW	2 3/4"	1 3/4"	4 3/4" x 12"

SHELF PACK: I

FINISHES: PB (605), S (630)

22 (.032) Gauge

Box Packed Only

For DOUBLE LOCK COMBINATION LOCKSETS with 2 1/8" holes with 3 5/8" centers

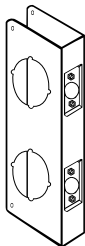

**151-CW
261-CW
481-CW**

NUMBER	BACKSET	DOOR	DIMENSIONS
151-CW	2 3/8"	1 3/8"	4" x 9"
261-CW	2 3/8"	1 3/4"	4" x 9"
481-CW	2 3/4"	1 3/4"	4 1/4" x 9"

SHELF PACK: I

FINISHES: PB (605), AB (609), BZ (612), IOB (613), S (630)

22 (.032) Gauge

Box Size - 4 1/2" x 9 3/4"

CW comes box packaged as standard.

Display Packaged also available. When ordering indicate by replacing the letters "CW" with "V" after the item number.

Display Package Size - 5 1/4" x 11"



For **DOUBLE LOCK COMBINATION LOCKSETS** with 2 1/8" holes with 4" centers

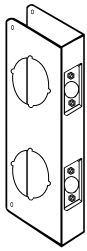

942-CW
943-CW

NUMBER	BACKSET	DOOR	DIMENSIONS
942-CW	2 3/8"	1 3/4"	4" x 9"
943-CW	2 3/4"	1 3/4"	4 1/4" x 9"

SHELF PACK: I

FINISHES: PB (605), AB (609), BZ (612), IOB (613), S (630)

22 (.032) Gauge

Box Size - 4 1/2" x 9 3/4"

CW comes box packaged as standard.

Display Packaged also available. When ordering indicate by replacing the letters "CW" with "V" after the item number.

Display Package Size - 5 1/4" x 11"

For **DOUBLE LOCK COMBINATION LOCKSETS** with 6" centers

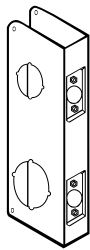

486-CW
hole sizes
1 1/2" over 2 1/8"

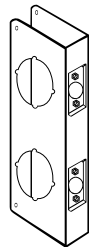

946-CW
hole sizes
2 1/8" over 2 1/8"

NUMBER	BACKSET	DOOR	DIMENSIONS
486-CW	2 3/4"	1 3/4"	4 1/2" x 12"
946-CW	2 3/4"	1 3/4"	4 1/2" x 12"

SHELF PACK: I

FINISHES: PB (605), S (630)

22 (.032) Gauge

Box Packed Only

BLANK WRAP-AROUND with TRIM SCREWS

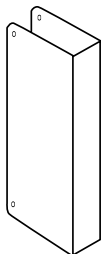

30-CW
40-CW
70-CW
80-CW
90-CW

NUMBER	DOOR	DIMENSIONS
30-CW	1 3/8"	4 1/4" x 9"
40-CW	1 3/4"	4 1/4" x 9"
70-CW	1 3/8"	4 1/4" x 4 1/2"
80-CW	1 3/4"	4 1/4" x 4 1/2"
90-CW	1 3/4"	5" x 12"

SHELF PACK: I

FINISHES: PB (605), AB (609), BZ (612), IOB (613), S (630)

22 (.032) Gauge

Box Size - 5 1/4" x 4 1/2" and 4 1/2" x 9 3/4"

CW comes box packaged as standard.

90-CW Box Packed Only

Display Packaged also available. When ordering indicate by replacing the letters "CW" with "V" after the item number.

Display Package Size - 5 1/4" x 11" and 5 1/4" x 6 1/2"

20" WRAP-AROUND

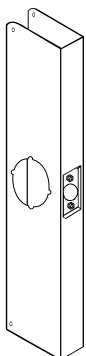

20-CW



20B-CW

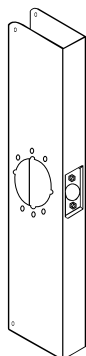

20-2-CW

NUMBER	BACKSET	DOOR	DIMENSIONS
20-CW	2 3/4"	1 3/4"	5" x 20"
20B-CW	-	1 3/4"	5" x 20"
20C-CW	2 3/8"	1 3/4"	5" x 20"
20-2-CW	2 3/4"	1 3/4"	5 3/4" x 20"

SHELF PACK: I

FINISHES: PB (605), S (630)

22 (.032) Gauge

Box Packed Only

- Beveled front
- Non-handed

For installing the **MARKS LEVERS & MEDECO LEVERS**

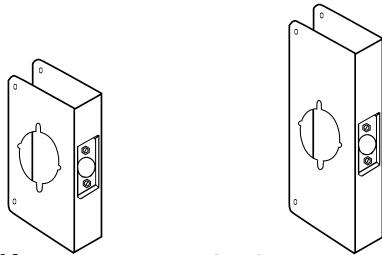

75-CW

95-CW

NUMBER	BACKSET	DOOR	DIMENSIONS
75-CW	2 3/4"	1 3/4"	4 3/4" x 5 1/2"
95-CW	2 3/4"	1 3/4"	4 3/4" x 9"

SHELF PACK: I **Box Packed Only**
FINISHES: PB (605), AB (609), BZ (612), S (630)
 22 (.032) Gauge

For installing the **BEST 93K LEVER LOCK, 73K LOCKSET, SARGENT 6500 SERIES**

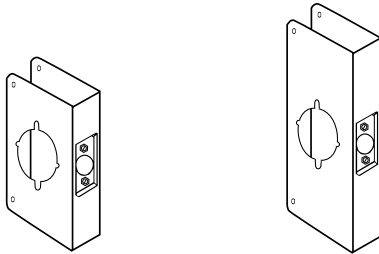

5K-CW

9K-CW

NUMBER	BACKSET	DOOR	DIMENSIONS
5K-CW	2 3/4"	1 3/4"	4 3/4" x 5 1/2"
9K-CW	2 3/4"	1 3/4"	4 3/4" x 9"

SHELF PACK: I **Box Packed Only**
FINISHES: PB (605), AB (609), BZ (612), S (630)
 22 (.032) Gauge

For use with **HEAVY DUTY GRADE 1 & GRADE 2 key-in-levers**

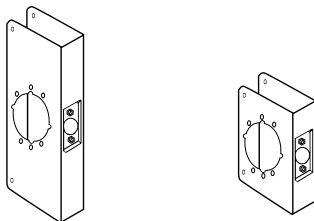

4-2-CW

81-2-CW

NUMBER	BACKSET	DOOR	DIMENSIONS
4-2-CW	2 3/4"	1 3/4"	4 3/4" x 9"
81-2-CW	2 3/4"	1 3/4"	4 3/4" x 4 1/2"

SHELF PACK: I **Box Packed Only**
FINISHES: (4-2-CW) PB (605), BZ (612), S (630)
 (81-2-CW) PB (605), AB (609), BZ (612), S (630)
 22 (.032) Gauge

- Works with Schlage Rhodes, Arrow Sierra, Yale Augusta, Sargent 10-Line, Corbin Russwin 3300 & 3600, Falcon T and B Series and Lori Retrofit Kit

Fits **SIMPLEX/UNICAN 1000 SERIES & 4000 SERIES**

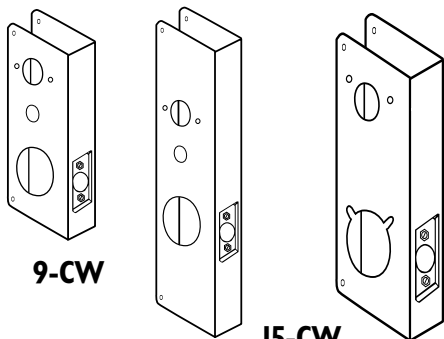

9-CW

15-CW

4000-CW

NUMBER	BACKSET	DOOR	DIMENSIONS
9-CW	2 3/4"	1 3/4"	5" x 9"
15-CW	2 3/4"	1 3/4"	5" x 15"
4000-2-CW	2 3/8"	1 3/4"	5" x 15"
4000-4-CW	2 3/4"	1 3/4"	5" x 15"

SHELF PACK: I **Box Packed Only**
FINISHES: PB (605), AB (609), S (630)
 22 (.032) Gauge



Fits ALARM LOCK 2700/T2 & 3000 SERIES TRILOGY LOCK

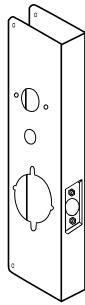

27-CW

NUMBER	BACKSET	DOOR	DIMENSIONS
27-CW	2 3/4"	1 3/4"	5" x 15"

SHELF PACK: 1 Box Packed Only
 FINISHES: PB (605), AB (609), S (630)
 22 (.032) Gauge

Fits BEST 93-KV LOCKS & MAS-HAMILTON POWER LEVERS

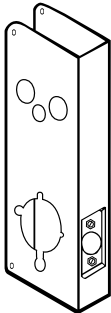

93-KV-CW

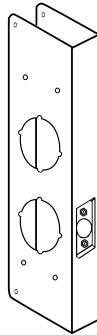

16-CW

NUMBER	BACKSET	DOOR	DIMENSIONS
93-KV-CW	2 3/4"	1 3/4"	5 1/2" x 12 3/4"
16-CW	2 3/4"	1 3/4"	5" x 15"

SHELF PACK: 1 Box Packed Only
 FINISHES: PB (605), AB (609), S (630)
 22 (.032) Gauge

Fits SCHLAGE COBRA LOCKS

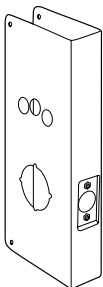

17-CW

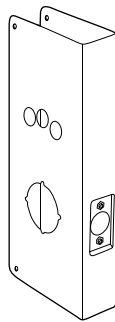

18-CW

NUMBER	BACKSET	DOOR	DIMENSIONS
17-CW	2 3/4"	1 3/4"	5" x 12"
18-CW	2 3/4"	1 3/4"	5" x 15"

SHELF PACK: 1 Box Packed Only
 FINISHES: 605, 612, 613, 630
 22 (.032) Gauge

Fits MARKS I-Q LOCKS

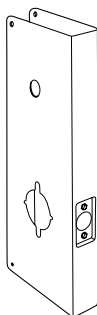

19-CW

NUMBER	BACKSET	DOOR	DIMENSIONS
19-CW	2 3/4"	1 3/4"	5" x 15"

SHELF PACK: 1 Box Packed Only
 FINISHES: 605, 613, 630
 22 (.032) Gauge



For conversion of **SIMPLEX 1000 SERIES & ALARM LOCK DL2500, 2700/T2 & 3000 SERIES** to key-in-knob lock

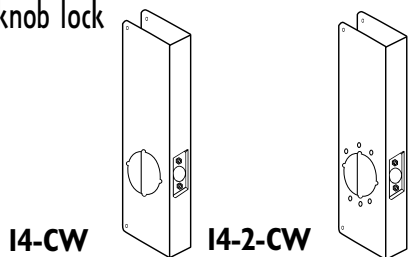

14-CW **14-2-CW**

NUMBER	BACKSET	DOOR	DIMENSIONS
14-CW	2 3/4"	1 3/4"	5" x 14"
14-2-CW	2 3/4"	1 3/4"	5" x 14"

SHELF PACK: I **Box Packed Only**
FINISHES: PB (605), AB (609), S (630)
 22 (.032) Gauge

MORTISE LOCK wrap-around plate for 86 cut-out

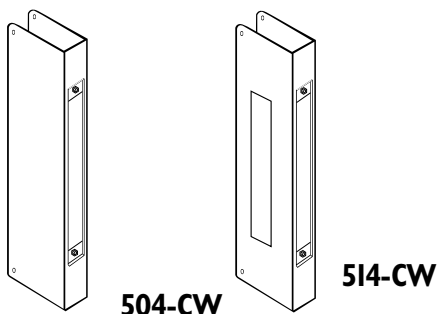

504-CW **514-CW**

NUMBER	BACKSET	DOOR	DIMENSIONS
504-CW	—	1 3/4"	5" x 12"
514-CW	2 3/4"	1 3/4"	5" x 12"

SHELF PACK: I **Box Packed Only**
FINISHES: PB (605), BZ (612), S (630)
 22 (.032) Gauge

- 8" x 1 1/4" Recess
- Drill spindle and thumb turn holes in field
- Rectangle size 1 5/8" x 7 5/16"
- 8" x 1 1/4" Recess

For LOCKS with **EXTENDED** or **CONVERTED BACKSETS**

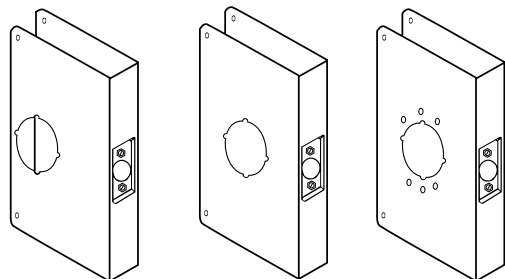

Extended 33-CW **Converted 33A-CW** **Converted 33A-2-CW**
55-CW **55A-CW** **55A-2-CW**

NUMBER	BACKSET	DOOR	DIMENSIONS
33-CW	3 3/4"	1 3/4"	5 1/2" x 9"
33A-2-CW	2 3/4"	1 3/4"	6 1/2" x 9"
33A-CW	2 3/4"	1 3/4"	6 1/2" x 9"
55-CW	5"	1 3/4"	6 1/2" x 9"
55A-2-CW	2 3/4"	1 3/4"	6 1/2" x 9"
55A-CW	2 3/4"	1 3/4"	6 1/2" x 9"

SHELF PACK: I **Box Packed Only**
FINISHES: PB (605), AB (609), BZ (612), S (630)
 22 (.032) Gauge

For **THICKER DOORS**

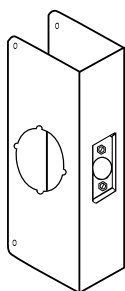

200-CW
200C-CW
212-CW
212C-CW
214-CW
214C-CW

NUMBER	BACKSET	DOOR	DIMENSIONS
200-CW	2 3/4"	2"	4 1/4" x 9"
200C-CW	2 3/8"	2"	4 1/4" x 9"
212-CW	2 3/4"	2 1/2"	4 1/4" x 9"
212C-CW	2 3/8"	2 1/2"	4 1/4" x 9"
214-CW	2 3/4"	2 1/4"	4 1/4" x 9"
214C-CW	2 3/8"	2 1/4"	4 1/4" x 9"

SHELF PACK: I **Box Packed only**
FINISHES: PB (605), S (630)
 22 (.032) Gauge

- Latch hole centered in door
- Available with lever Prep. - Custom order only



DOOR REINFORCER for deadbolts & key-in-knob locks

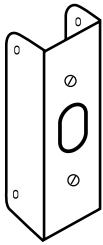

10-FE
20-FE

NUMBER	BACKSET	DOOR	DIMENSIONS
10-FE	—	1 3/8"	4 1/2" x 1"
20-FE	—	1 3/4"	4 1/2" x 1"

SHELF PACK: 10
FINISHES: PB (605), AB (609), S (630)
22 (.032) Gauge

Display Package Size - 4" x 7 3/4"

MORTISE LOCK wrap-around plate for 86 cut-out



504-FE

NUMBER	BACKSET	DOOR	DIMENSIONS
504-FE	—	1 3/4"	12" x 1"

SHELF PACK: 1
FINISHES: S (630)
22 (.032) Gauge
• 8" x 1 1/4" Recess

Box Packed Only

INTERIOR WRAP-AROUNDS

DON-JO MFG., INC. offers a line of Interior Wrap-Arounds. Each is manufactured from high quality prefinished steel brass plated material and is recommended for INTERIOR use only.
Available for: 1, 2, 3, 4, 5, 6, 7, 8, 51, 61, 71, 81, 30, 40, 70, 80, 154, 264, 484, 151, 261, 481, 258, 942, 943

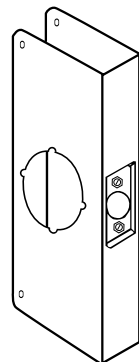

How to Order:
ie: 1-PB-IW

FLAT FRONT WRAP-AROUNDS

DON-JO MFG., INC. also offers a complete line of "original" Flat Front Wrap-Arounds. They are perfect for repairing, reinforcing or remodeling doors. Speed nuts are supplied with all Flat Front Wrap-Arounds and can be used in certain conditions when door is severely damaged or when replacing a mortise lock.

Available for: 1, 2, 3, 4, 5, 6, 7, 8, 51, 61, 71, 81, 30, 40, 70, 80, 154, 264, 484, 151, 261, 481, 258, 942, 943

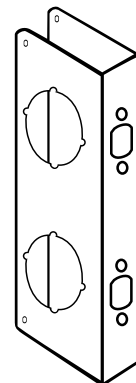
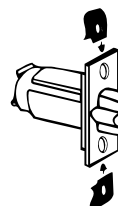

How to Order:
ie: 1-PB-VF