

Adjustable 2-Way Square Corner Replacement Entry Latch Matte Black

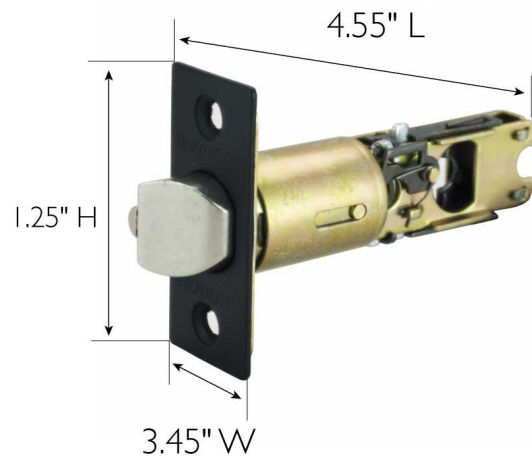

SPECIFICATIONS

MATERIAL CONSTRUCTION:	Zinc	REMOVABLE CORE:	No
LOCK FUNCTION:	Latch	LATCH FACEPLATE:	Round Corner
DEADBOLT FUNCTION:	N/A	LATCH BACKSET:	Adj. 2-3/8" 2-3/4"
EXTERIOR MAX PROJECTION:	N/A	LATCH TYPE:	2 Way (fixed faceplate)
INTERIOR MAX PROJECTION:	N/A	LATCHBOLT THROW DISTANCE:	0.5
ASSEMBLED WEIGHT:	0.25 lbs	SPINDLE TYPE:	Half Moon
ASSEMBLED HEIGHT:	1.25" H	MOUNTING HARDWARE INCLUDED:	Yes
ASSEMBLED LENGTH:	4.55" L	TOOLS NEEDED FOR INSTALLATION:	Screwdriver
ASSEMBLED WIDTH:	3.45" W		
CROSS BORE:	2.13"		
EDGE BORE:	1"		
HANDING:	Reversible		

WARRANTY:	5-Year limited warranty
ANSI CERTIFICATION:	Grade 3
BHMA GRADE:	3
FIRE RATED:	No
ADA COMPLIANT:	No



TYPE:
JOB:
ORDER CODE:
APPROVALS: