



Perfectly quiet.
Perfectly green.



Learn more about the Breez Ventilation Fan,
the ideal bathroom solution for green construction.

www.deltabreez.com



Delta Products Corporation

4405 Cushing Parkway
Fremont, CA 94538
tel 1.888.979.9889
fax 1.510.226.5097



Solutions for a better tomorrow.

Established in 1971, Delta Group is a leading global provider of industrial electronics products. The company's mission is to provide innovative, clean and efficient energy solutions for a better tomorrow.

The energy saving bathroom solution.

The introduction of the Breez Ventilation Fan marks a new achievement in green construction for bathroom ventilation. Factory controlled tests reveal the Breez Ventilation Fan surpasses popular competitors' models with advanced functionality, lower power consumption, and lower noise.

Innovative design for long life, low noise and low power consumption.

The Breez Ventilation Fan combines several design innovations, including a switch power supply and DC brushless motor to provide a quieter solution with energy savings up to 65% compared to similar products.

The Breez Ventilation Fan is easy to install in new construction or an existing bathroom to deliver an unobtrusive appliance with aesthetically pleasing results. The product is safety certified and has passed the EMC test.

Description

Low noise ceiling mount ventilating fans with and without humidity sensors, rated for continuous running. Evaluated by Underwriter Laboratories and conforms to both UL and cUL safety standards.

Motor/Blower

- Power Rating of 110~220volts/50~60Hz.
- DC Brushless motor engineered to run continuously.
- Motor equipped with thermal cutoff fuse.
- Removable with permanently lubricated plug-in motor.

Housing

- Galvanized steel body.
- Detachable 4" diameter duct adapter.
- Built in backdraft damper.
- Easy installation.

Grille

- Attractive design using ABS material.
- Attaches directly to housing with torsion springs.

Warranty

- 3 year limited warranty.

Features

- Duct diameter no less than 4"
- UL and cUL listed for tub/shower enclosure when used with GFCI branch circuit wiring.

DC Motor Technology

- Allows fan to operate in full speed mode or dual speed or humidity control modes by cycling ON/OFF switch.
- Built in soft start function to increase bearings life.
- Automatically powers OFF when impeller is locked abnormally.

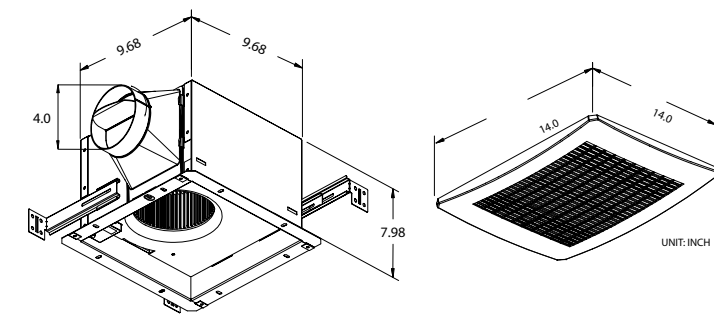

Delta Breez Ventilation Fan Specifications



Breez ceiling mount ventilation fans feature an innovative DC brushless motor for ultra-quiet operation and low power consumption. All are UL and cUL safety approved and rated for continuous running.

VFB25AC - 80 CFM Exhaust Fan

Static Pressure (Inches w.g.)	0.1	0.25
Air Flow (CFM)	80	54.2
Sones	<0.3	N/A
Power Consumption (Watts)	7.1	8.3
Energy Efficiency (CFM/Watt)	11.75	6.51
Speed (RPM)	876	1111
Current (Amps)	0.12 @ 110 Vac	
Power Rating (V/Hz)	110~220/50~60	

Fan Curve

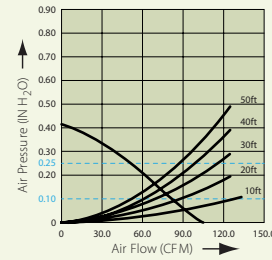

VFB25ACH - 80 CFM Humidity Sensor Exhaust Fan

Static Pressure (Inches w.g.)	0.1	0.25
Air Flow (CFM)	80	54.2
Sones	<0.3	N/A
Power Consumption (Watts)	7.1	8.3
Energy Efficiency (CFM/Watt)	11.75	6.51
Speed (RPM)	876	1111
Current (Amps)	0.12 @ 110 Vac	
Power Rating (V/Hz)	110~220/50~60	

Fan Curve

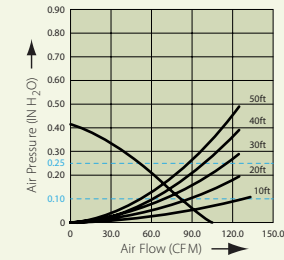

Humidity Control

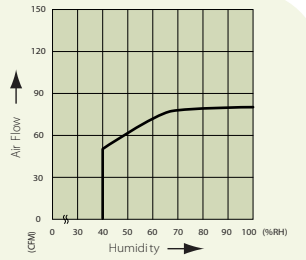

VFB25AD - 110 CFM Exhaust Fan

Static Pressure (Inches w.g.)	0.1	0.25
Air Flow (CFM)	110	83
Sones	1.2	N/A
Power Consumption (Watts)	18.5	17.5
Energy Efficiency (CFM/Watt)	6.24	4.71
Speed (RPM)	983	1134
Current (Amps)	0.22 @ 110 Vac	
Power Rating (V/Hz)	110~220/50~60	

Fan Curve

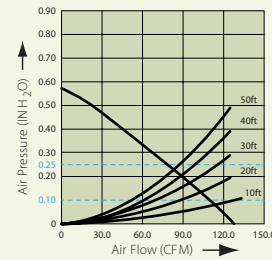

VFB25ADH - 110 CFM Humidity Sensor Exhaust Fan

Static Pressure (Inches w.g.)	0.1	0.25
Air Flow (CFM)	110	83
Sones	1.2	N/A
Power Consumption (Watts)	18.5	17.5
Energy Efficiency (CFM/Watt)	6.24	4.71
Speed (RPM)	983	1134
Current (Amps)	0.22 @ 110 Vac	
Power Rating (V/Hz)	110~220/50~60	

Fan Curve

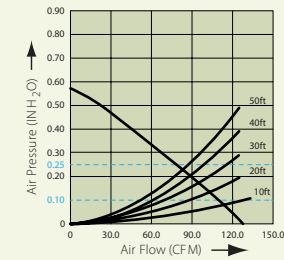

Humidity Control

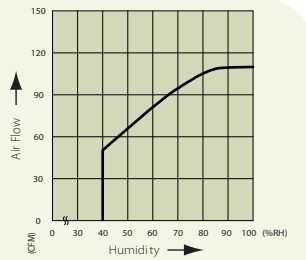

VFB25AX - 80/110 CFM Dual Speed Exhaust Fan

Fan Speed	High		Low	
Static Pressure (Inches w.g.)	0.1	0.25	0.1	0.25
Air Flow (CFM)	110	90.9	80	53.3
Sones	1.0	N/A	0.5	N/A
Power Consumption (Watts)	16.0	18.1	7.7	8.7
Energy Efficiency (CFM/Watt)	7.00	4.99	10.40	6.11
Speed (RPM)	1015	1189	890	1082
Current (Amps)	0.22 @ 110 Vac		0.12 @ 110 Vac	
Power Rating (V/Hz)	110~220/50~60			

Fan Curve

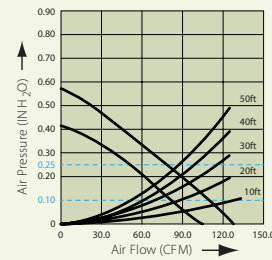

VFB25AEH - 130 CFM Humidity Sensor Exhaust Fan

Static Pressure (Inches w.g.)	0.1	0.25
Air Flow (CFM)	130	111.1
Sones	1.3	N/A
Power Consumption (Watts)	19.1	18.8
Energy Efficiency (CFM/Watt)	7.07	5.92
Speed (RPM)	1083	1219
Current (Amps)	0.36 @ 110 Vac	
Power Rating (V/Hz)	110~220/50~60	

Fan Curve

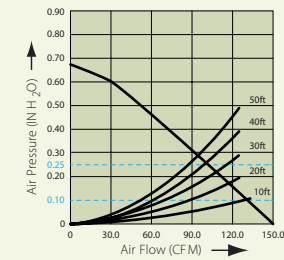

Humidity Control

