

55011 & 57011
Series/Series/Seria



Transitional Hand Piece
2 Setting
Pieza de Mano Transicional
2 Ajustes
Douche à main Transicional
2 réglages

RP7405▲
Hand Held Shower
Regadera de Mano
Douche à main

57014
Series/Series/Seria



Transitional Hand Piece
3 Setting
Pieza de Mano Transicional
3 Ajustes
Douche à main Transicional
3 réglages

RP48769▲
Hand Held Shower
Regadera de Mano
Douche à main

55021 & 57021
Series/Series/Seria



Traditional Hand Piece
3 Setting
Pieza de Mano Tradicional
3 Ajustes
Douche à main Tradicional
3 réglages

RP48770▲
Hand Held Shower
Regadera de Mano
Douche à main

55051 & 57051
Series/Series/Seria



Dryden™ Hand Piece
Single Setting
Pieza de Mano Dryden™
Un Ajuste
Douche à main Dryden™
Un réglage

RP52589▲
Hand Held Shower
Regadera de Mano
Douche à main

55085 & 57085
Series/Series/Seria



Trinsic™ / Compel™ / Grial®
Single Function
Pieza de Mano Trinsic™ /
Compel™ / Grial® Una Función
Douche à main Trinsic™ /
Compel™ / Grial® Une fonction

RP44586▲
Hand Held Shower
Ducha Manual

55013
Series/Series/Seria

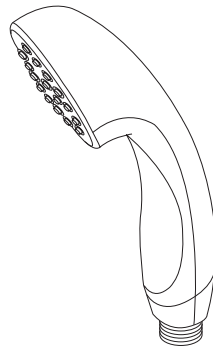

Transitional Hand Piece
Single Setting
Pieza de Mano Transicional
Un Ajuste
Douche à main Transicional
Un réglage

RP46683▲
Hand Held Shower
Ducha Manual

55020
Series/Series/Seria



Traditional Hand Piece
Single Setting
Pieza de Mano Tradicional
Un Ajuste
Douche à main Tradicional
Un réglage

RP46680▲
Hand Held Shower
Ducha Manual

55530 & 57530
Series/Series/Seria



Vero™ Hand Piece
Single Setting
Pieza de Mano Vero™
Un Ajuste
Douche à main Vero™
Un réglage

RP62954▲
Hand Held Shower
Ducha Manual

▲ Specify Finish / Especificque el Acabado / Précisez le Fini

**57510
Series/Series/Seria**

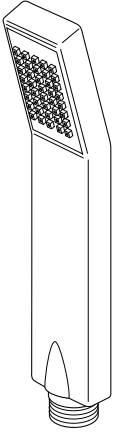

**Arzo® Hand Piece
Single Setting
Pieza de Mano Arzo®
Un Ajuste
Douche à main Arzo®
Un réglage**

**57923 & 59210
Series/Series/Seria**



**Addison® Hand Piece
Single Setting
Pieza de Mano Addison®
Un Ajuste
Douche à main Addison®
Un réglage**

**51567 & 55567
Series/Series/Seria**

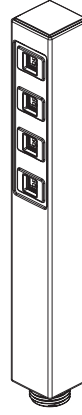

**Ara™ Hand Piece
Single Setting
Pieza de Mano Ara™
Un Ajuste
Douche à main Ara^{MC}
Un réglage**

**51552 & 55552
Series/Series/Seria**

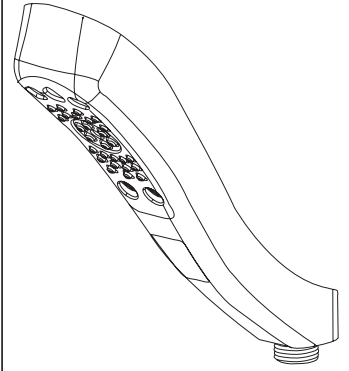

**Hand Piece 4 Setting
Pieza de Mano 4 Ajustes
Douche à main 4 réglages**

RP61294▲
Mounting Bracket
Consola de montaje
Support

RP48296▲
Hand Held Shower
Regadera de Mano
Douche à main

RP61283▲
Hand Held Shower
Regadera de Mano
Douche à main

59567-PK▲
Handshower
Regadera de Mano
Douche à main

59552▲
Handshower
Regadera de Mano
Douche à main

**55011, 55013, 55020, 55021, 55085,
57510 & 57923
Series/Series/Seria**

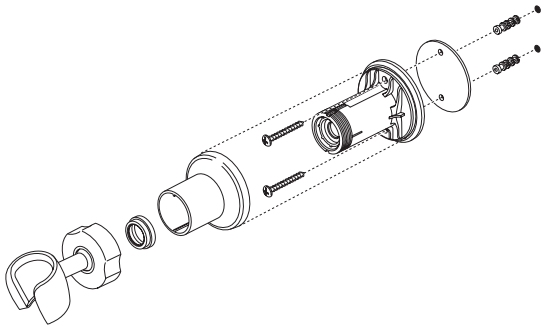

RP64157▲
Hose & Gaskets
Manguera y Empaques
Tuyau souple et joints

**55552, 55567, 55051 & 55530
Series/Series/Seria**

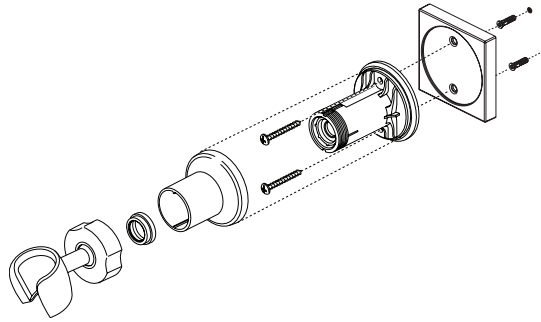

U4010-PK▲
Handshower holder
Teleducha titular
Support douchette

U495D -▲60-PK
Hose & Gaskets
Manguera y Empaques
Tuyau souple et joints

▲ Specify Finish
▲ Especificque el Acabado
▲ Précisez le Fini

**51567, 55011, 55013,
55567, 56613, 57011,
57014 & 57510
Series/Series/Seria**



**51552, 54613, 55020,
55021, 55051, 55085,
55530, 55552, 57021,
57051, 57085, 57530,
57923 & 59210
Series/Series/Seria**

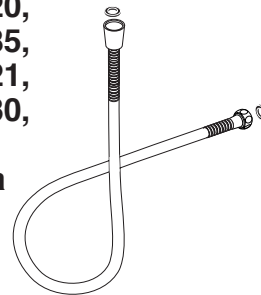

57021
Series/Series/Seria

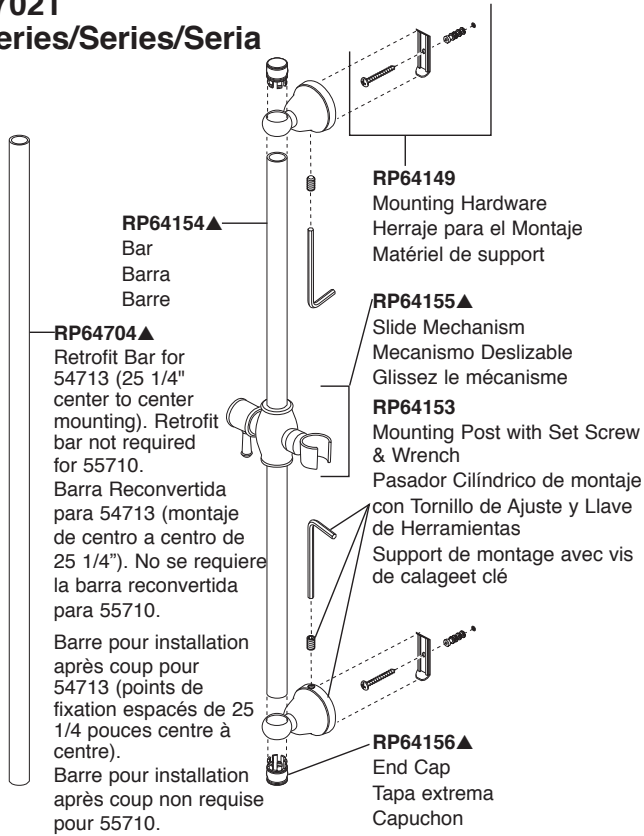

57011, 57014 & 57085
Series/Series/Seria

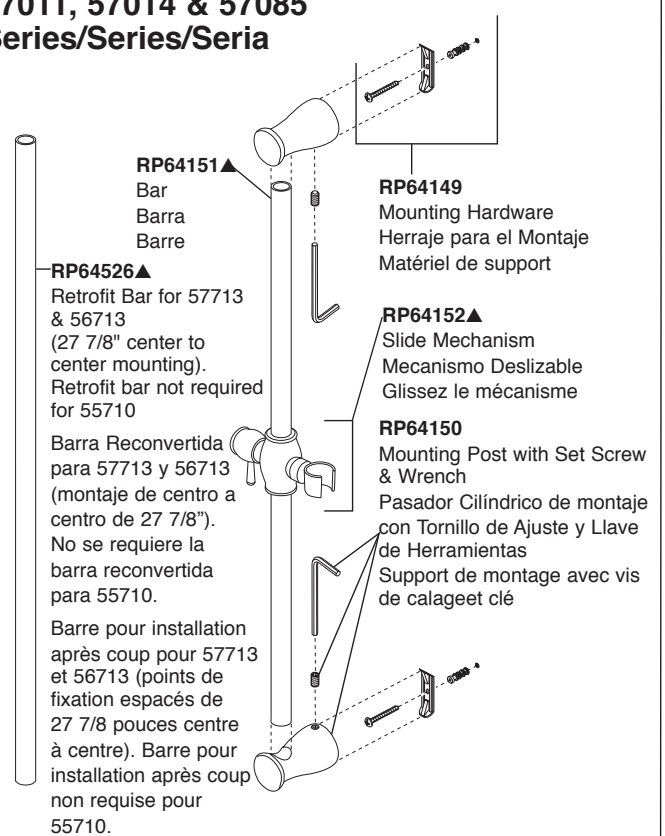

51552, 51567, 57051 & 57530 Series/Series/Seria

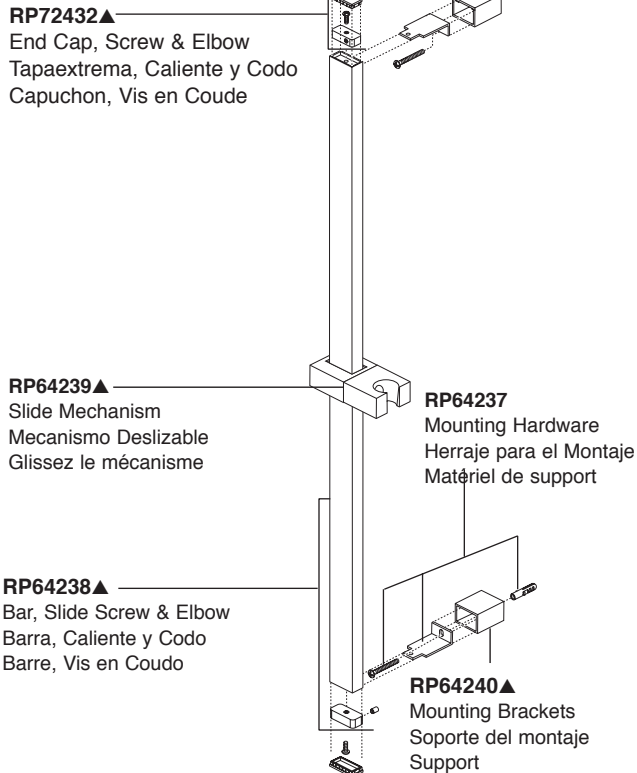

59210
Series/Series/Seria

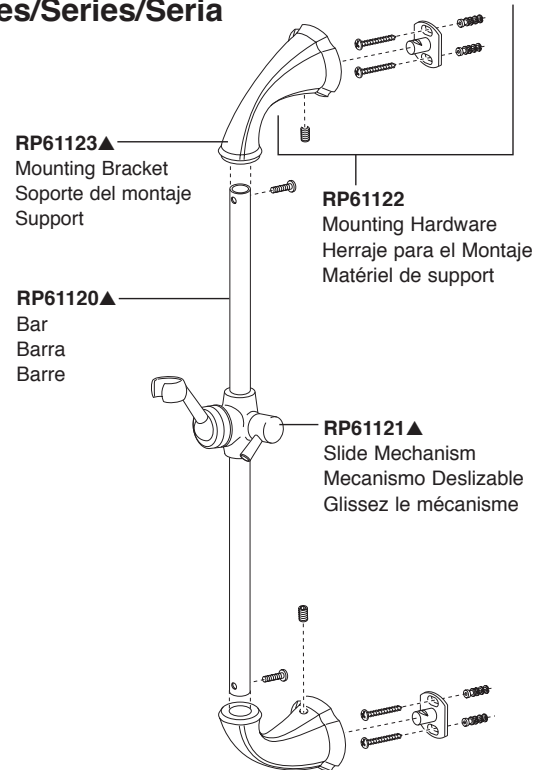

- ▲ Specify Finish
- ▲ Especificque el Acabado
- ▲ Précisez le Fini

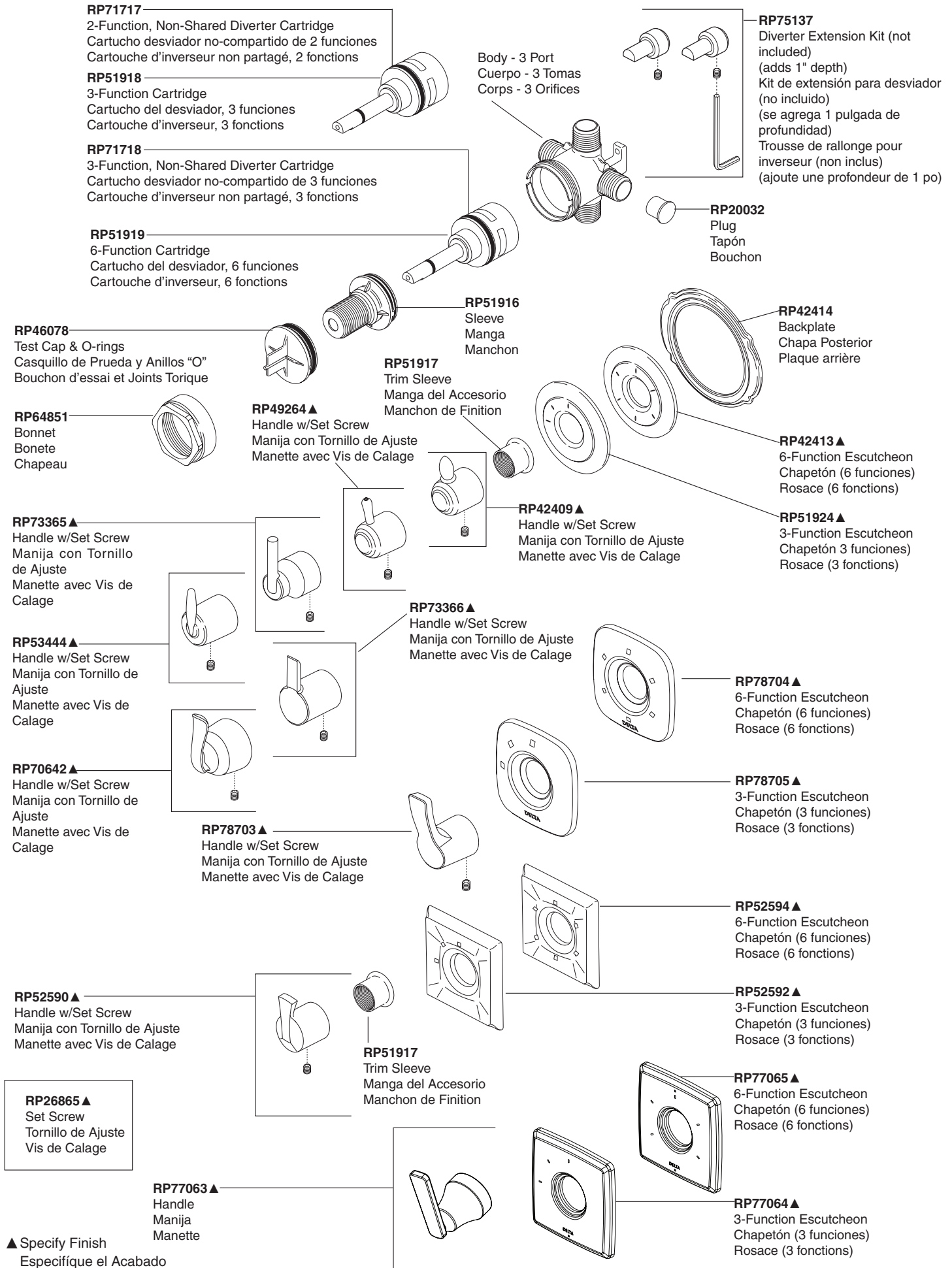

▲ Specify Finish
Especifique el Acabado
Précisez le Fini

▲ Specify Finish
Especifique el Acabado
Précisez le Fini

RP51917
Trim Sleeve
Manga del Accesorio
Manchon de Finition

RP53445 ▲
Arzo® Handle w/Set
Screw
Manija con Tornillo
de Ajuste - Arzo®
Manette avec Vis de
Calage - Arzo®

RP62962 ▲
Vero® Handle w/Set
Screw
Manija con Tornillo de
Ajuste - Vero®
Manette avec Vis de
Calage - Vero®

RP75443 ▲
Ara™ Handle w/Set
Screw
Manija con Tornillo
de Ajuste - Ara™
Manette avec Vis de
Calage - Ara^{MC}

RP61656 ▲
Addison™ Handle w/Set
Screw
Manija con Tornillo de
Ajuste - Addison™
Manette avec Vis de
Calage - Addison^{MC}

H595 ▲
Cassidy™ Handle w/Set Screw
Manija con Tornillo de Ajuste - Cassidy™
Manette avec Vis de Calage - Cassidy^{MC}

H597 ▲
Cassidy™ Handle w/Set
Screw
Manija con Tornillo de
Ajuste - Cassidy™
Manette avec Vis de
Calage - Cassidy^{MC}

RP72561 ▲
Buttons & Set Screws
Botones y Tornillos de Ajuste
Boutons et Vis de Calage

RP51917
Trim Sleeve
Manga del Accesorio
Manchon de Finition

RP51917
Trim Sleeve
Manga del Accesorio
Manchon de Finition

RP72560 ▲
Cassidy™ 6-Function Escutcheon
Chapetón (6 funciones) - Cassidy™
Rosace (6 fonctions)- Cassidy^{MC}

RP72559 ▲
Cassidy™ 3-Function Escutcheon
Chapetón (3 funciones) - Cassidy™
Rosace (3 fonctions)- Cassidy^{MC}

RP72561 ▲
Buttons & Set Screws
Botones y Tornillos de Ajuste
Boutons et Vis de Calage

H598 ▲
Cassidy™ Handle w/Set Screw
Manija con Tornillo de Ajuste - Cassidy™
Manette avec Vis de Calage - Cassidy^{MC}

RP53446 ▲
Arzo® 6-Function Escutcheon
Chapetón (6 funciones) - Arzo®
Rosace (6 fonctions)- Arzo®

RP53447 ▲
Arzo® 3-Function Escutcheon
Chapetón (3 funciones) - Arzo®
Rosace (3 fonctions)- Arzo®

RP62381 ▲
Vero® / Ara™
6-Function Escutcheon
Chapetón (6 funciones) -
Vero® / Ara™
Rosace (6 fonctions)-
Vero® / Ara^{MC}

RP62380 ▲
Vero® / Ara™
3-Function Escutcheon
Chapetón (3 funciones) -
Vero® / Ara™
Rosace (3 fonctions)-
Vero® / Ara^{MC}

RP61658 ▲
Addison™ 6-Function Escutcheon
Chapetón (6 funciones) -
Addison™
Rosace (6 fonctions)- Addison^{MC}

RP61657 ▲
Addison™ 3-Function Escutcheon
Chapetón (3 funciones) - Addison™
Rosace (3 fonctions)- Addison^{MC}

RP51917
Trim Sleeve
Manga del Accesorio
Manchon de Finition

RP72561 ▲
Buttons & Set Screws
Botones y Tornillos de Ajuste
Boutons et Vis de Calage

Using New Trim With Rough R11600

Para el uso de un accesorio nuevo
con tuberías internas R11600

Utilisation de la nouvelle finition avec les soupapes R11600

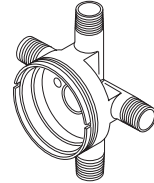

R11600

If you have **R11600** installed you will need to order **RP42410** (cartridge assembly), **RP37902** (3 function stem extender) OR **RP37903** (6 function stem extender) and **RP37890** (extension screw) to use the new trim.
Note: RP42412 (trim sleeve) may be needed for installations between 3.5 and 4.0 inches deep from the finished wall surface.

Si usted tiene instalado la pieza **R11600**, necesitará ordenar **RP42410** (ensamble del cartucho), **RP37902** (extensión de espiga de 3 funciones) o **RP37903** (extensión de espiga de 6 funciones) y **RP37890** (tornillo de extensión) para utilizar el accesorio nuevo.
Nota: La pieza RP42412 (manga de accesorio) puede ser necesaria para las instalaciones de 3.5 a 4.0 pulgadas de profundidad desde la superficial de la pared acabada.

Si vous avez installé l'article **R11600**, vous devez commander les articles **RP42410** (cartouche), **RP37902** (rallonge de tige pour soupape à 3 fonctions) OU **RP37903** (rallonge de tige pour soupape à 6 fonctions) et **RP37890** (vis de rallonge) et les utiliser avec la nouvelle finition.
Note: L'article RP42412 (manchon de finition) peut être nécessaire pour les installations présentant un écart de 3,5 à 4 pouces de profondeur par rapport à la surface finie du mur.

RP42410
Cartridge Assembly
Ensamble del Cartucho
Cartouche

RP37902
3 function stem extender
Extensión para la espiga -
Función 3
Rallonge de tige - 3 fonctions

RP37903
6 function stem extender
Extensión para la espiga -
Función 6
Rallonge de tige - 6 fonctions

RP37890
Extension Screw
Tornillos de Extension
Vis de Rallonge

RP42412
Trim Sleeve
Manga del Accesorio
Manchon de Finition

T14155, T14255-LHP, T14255-H2OLHP, T14455-LHP, & T14455-H2OLHP Models / Modelos / Modèles



RP34355 ▲
Showerhead
Cabeza de Rogadora
Pomme de Douche



RP70172 ▲
Showerhead
Cabeza de Rogadora
Pomme de Douche



RP6023 ▲
Shower Arm
Brazo de la Rogadora
Tuyau de Pomme de Douche



RP34356 ▲
Shower Flange
Pestaña de la Rogadora
Colerette

RP34353 ▲
Escutcheon
Roseta
Rosace avec Orifice

RP34359 ▲
Trim Ring
Aro de accesorio
Anneau décoratif

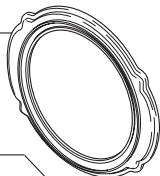

RP196 ▲
Trim Screws/Atornillos de
Franja/Vis de Finition

RP12630 ▲
For Longer Screws
Para Tornillos Más Grandes
Pour Vis Plus Longues

*** RP46074**
Valve Cartridge
Válvula de Cartucho
Cartouche

RP23336
O-Ring
Anillo "O"
Joint Torique

RP43233
Spacer
Separadores
Pièce D'espacement

RP50879 ▲
Trim Sleeve
Manga de Franja
Manchon de Finition

RP4993
Seats & Springs
Asientos y Resortes
Sièges et Ressorts

RP14414
O-Rings
Anillo "O"
Joint Toriques



RP43233
Spacer
Separadores
Pièce D'espacement

RP29569
Spacer
Separadores
Pièce D'espacement

H716 ▲
Handle Kit
Juego de herrajes
de la Manija
Manette en kit

RP26865
Set Screw
Tornillo de Ajuste
Vis de Calage

RP41898
Glide Ring
Aro para Deslizar
L'anneau de
Glissement

† Designates the accent color
on split finish models.

† Designa el color para acentuar
los modelos con acabados divididos.
† Désigne la couleur contrastante sur
les modèles à deux finis.

▲ Specify Finish
Especifique el Acabado
Précisez le Fini

H712 ▲
Handle Kit
Juego de herrajes de la Manija
Manette en kit

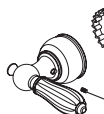

RP29569
Spacer
Separadores
Pièce D'espacement

RP26865
Set Screw
Tornillo de Ajuste
Vis de Calage

RP34349 ▲ †
Finial
Pomo
Grain



RP43028 ▲
Tub Spout/Non Diverter
Tubo de Salida para Bañera/
Sin Desviador
Bec/Sans Dérivation

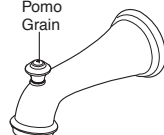

RP34357 ▲
Tub Spout/Pull-Up Diverter
Tubo de Salida para Bañera/
Botón Desviador de Alzar
Bec/avec dérivation à tirette

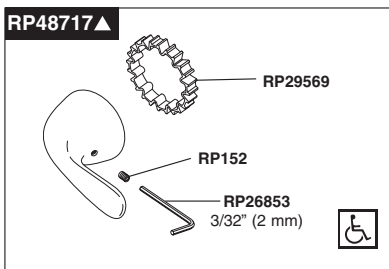
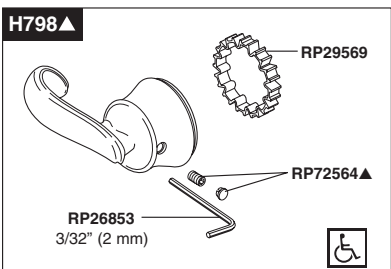
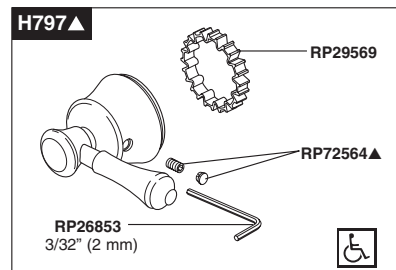
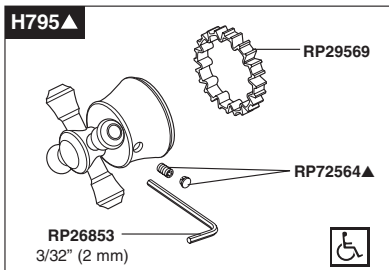
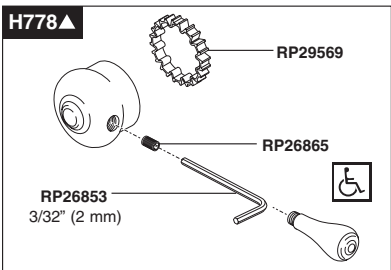
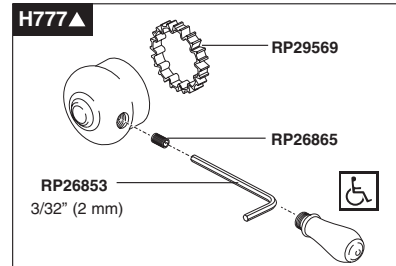
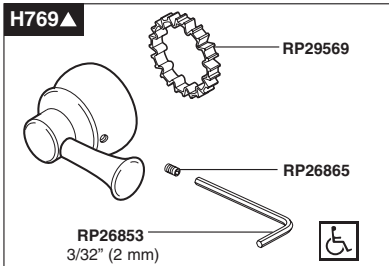
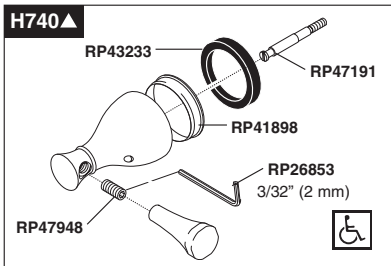
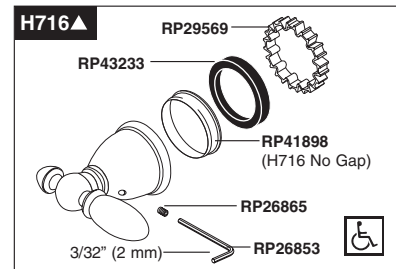
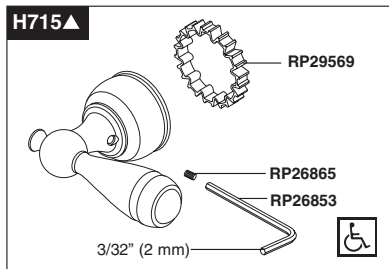
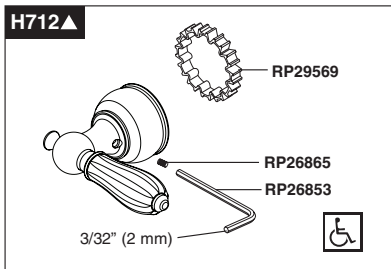
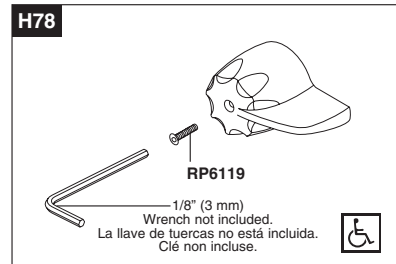
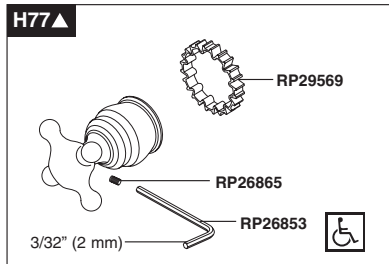
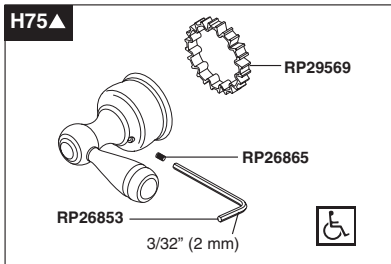
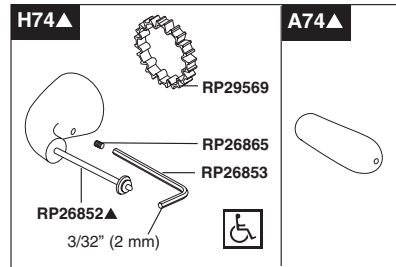
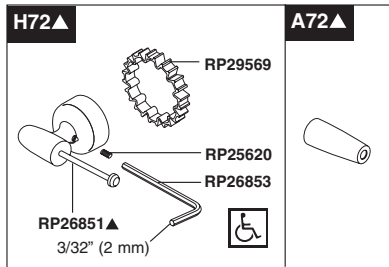
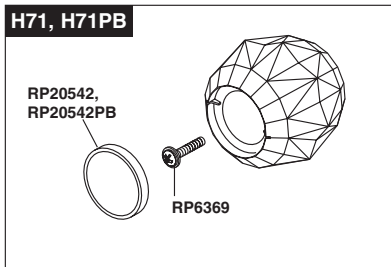

▲ Specify Finish
Especifique el Acabado
Précisez le Fini

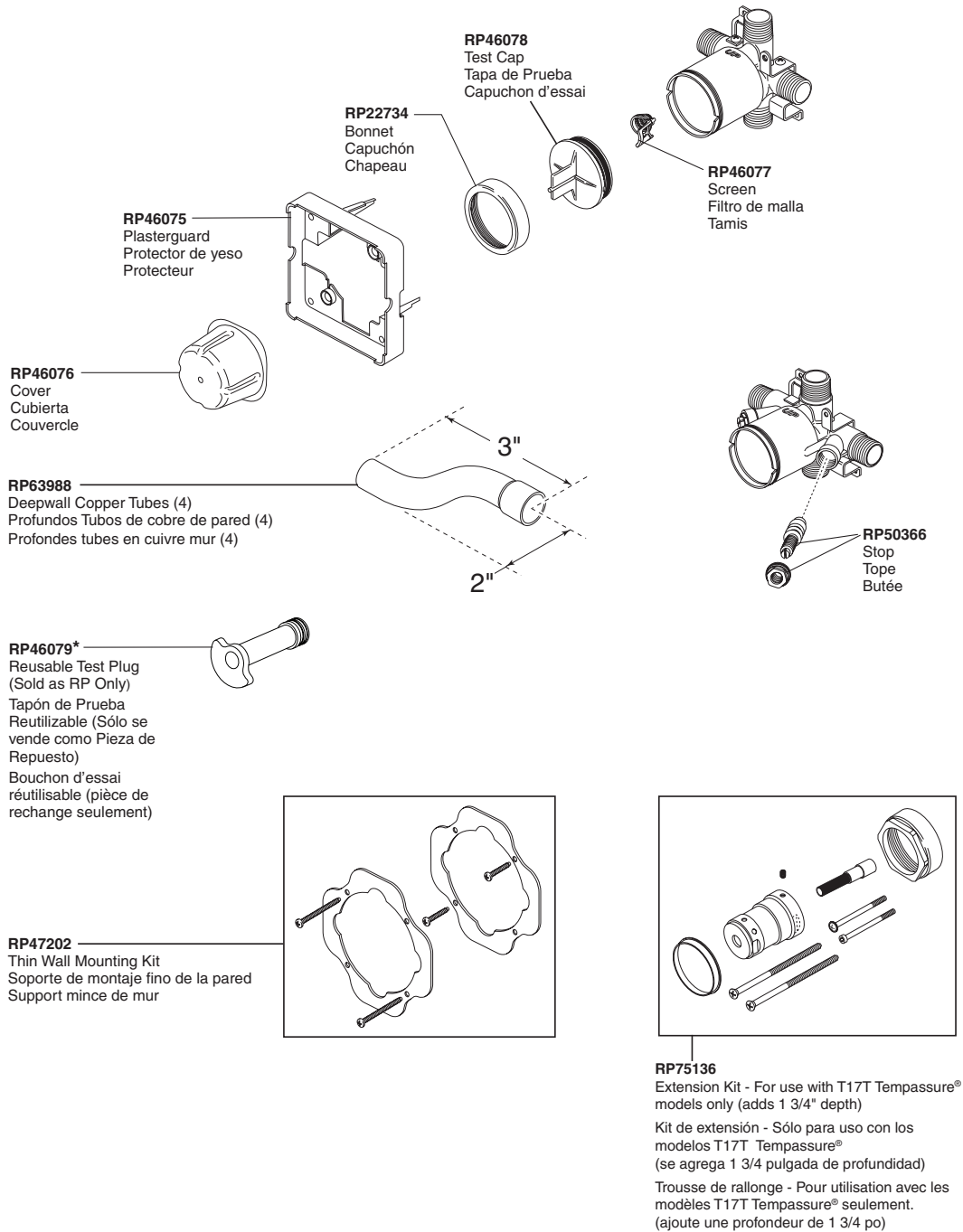

*Used to plug one inlet side (Hot or Cold) to prevent cross flow when checking for leaks before the cartridge is installed. Insert into the inlet, place test cap and use the bonnet to secure in place.

*Tapaban una entrada lateral (caliente o frío) para prevenir flujo cruzado cuando la comprobación para saber si hay escapes antes del cartucho está instalada. El relleno en la entrada, casquillo de la prueba del lugar y utiliza el capo para asegurar en lugar.

*Branchaient une admission latérale (chaud ou froid) pour empêcher l'écoulement en travers quand la vérification les fuites avant la cartouche est installée. L'insertion dans l'admission, chapeau d'essai d'endroit et emploient le capot pour fixer en place.

Model / Modelo / Modèle
R11000

