

# MONROVIA™

Models/Modelos/Modèles  
9191T-DST & 9991T-DST

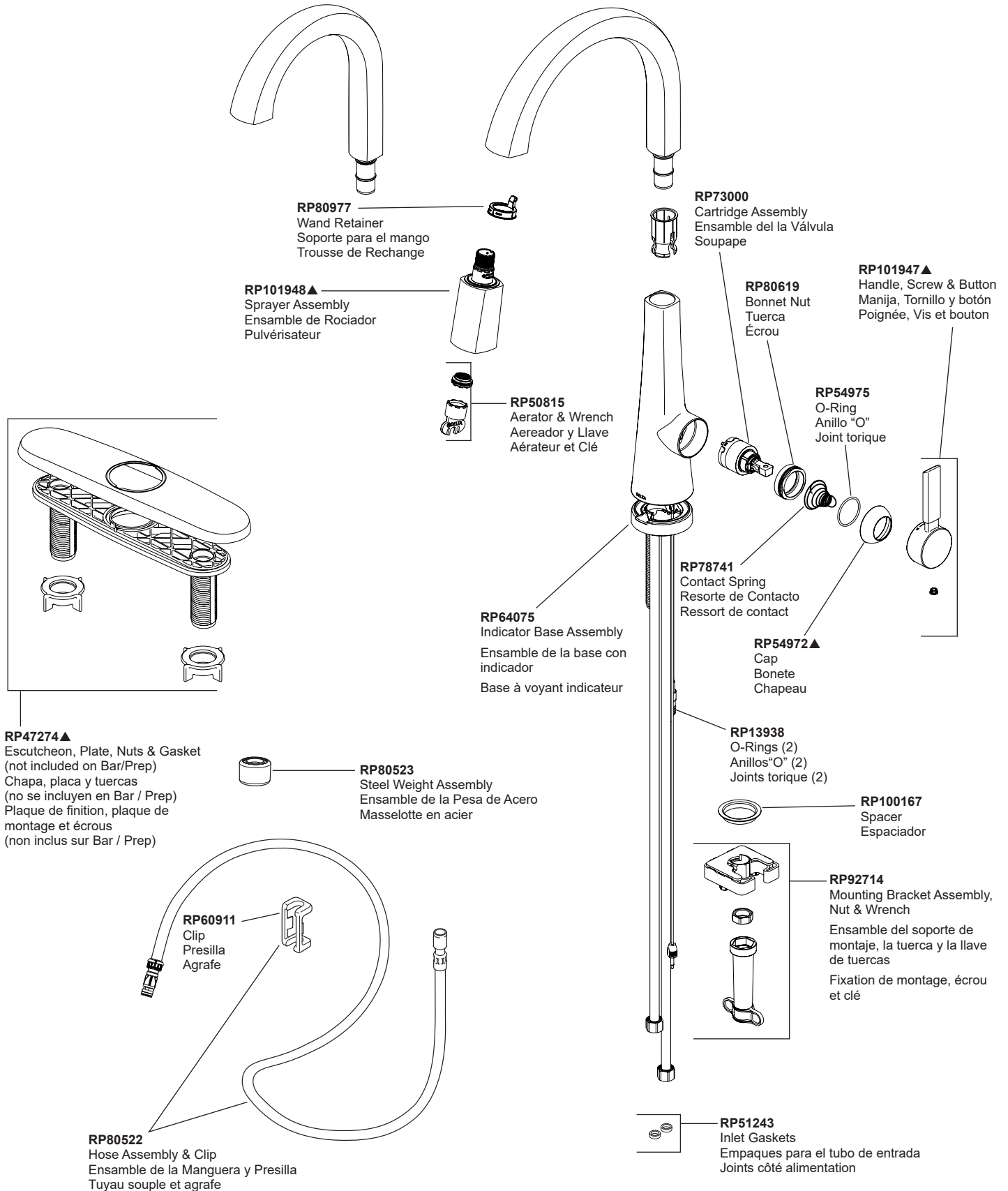

▲Specify Finish / Especificque el Acabado / Précisez le Fini

# MONROVIA™

## Models/Modelos/Modèles 9191T-DST & 9991T-DST

### EP92546

Solenoid Assembly  
Ensamble de Solenoide  
Électrovanne

For PC, SS, AR, CZ, PN & KS finishes, order **EP92546**  
For BL, MW, RB & SP finishes, order **EP92546XX**

Para acabados PC, SS, AR, CZ, PN y KS, ordene **EP92546**  
Para acabados BL, MW, RB y SP, ordene **EP92546XX**

Pour les finis PC, SS, AR, CZ, PN et KS, commandez **EP92546**  
Pour les finis BL, MW, RB et SP, commandez **EP92546XX**

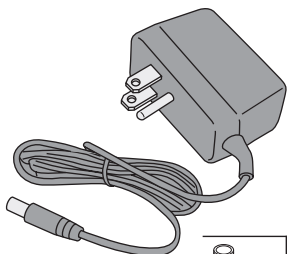

### EP73954

9 Volt Power Supply  
(Accessory Order Only)  
Fuente de alimentación de 9 voltios  
(Orden de accesorios solamente)  
Alimentation électrique 9 volts  
(L'accessoire seulement)

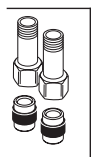

### RP53468

Check Valves  
Válvulas Checadoras  
Clapets de non-retour



### RP50952

Cut-To-Fit Plastic Sleeves  
Casquillos cortados a la medida  
Bagues d'extrémité pour tubes coupés

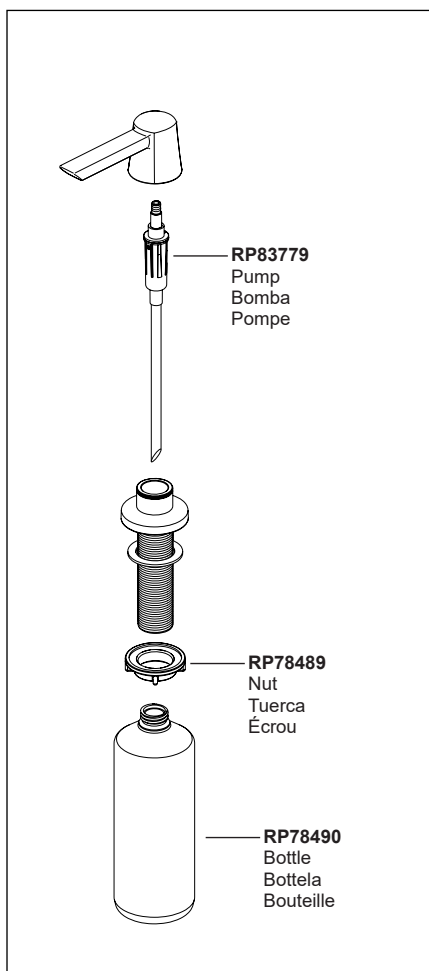

### RP83779

Pump  
Bomba  
Pompe

### RP78489

Nut  
Tuerca  
Écrou

### RP78490

Bottle  
Botella  
Bouteille

### RP101850▲

Dispenser Assembly  
Ensamble del Dispensador  
Distributeur

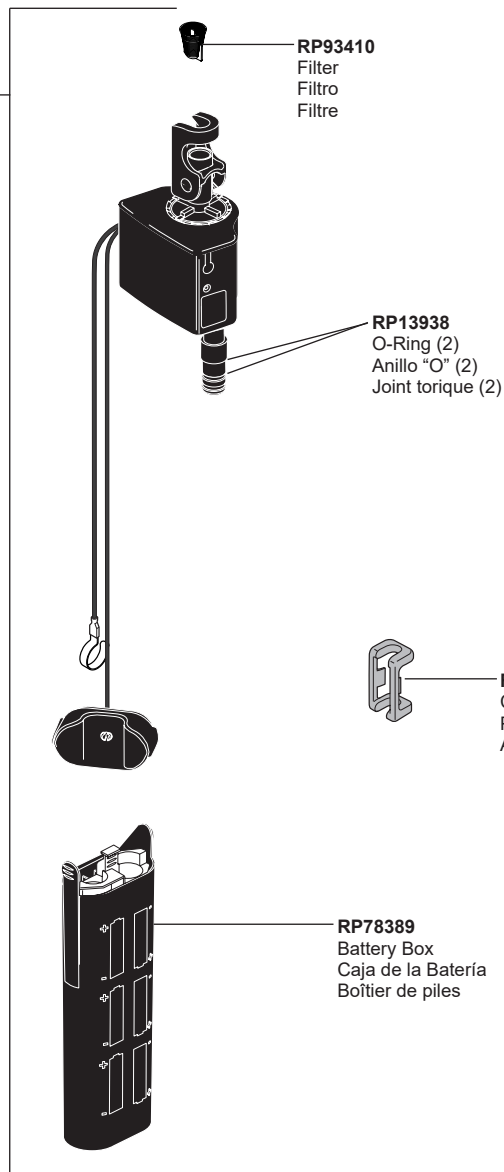

**RP93410**  
Filter  
Filtro  
Filtre

### RP13938

O-Ring (2)  
Anillo "O" (2)  
Joint torique (2)



### RP60911

Clip  
Presilla  
Agrafe

### RP78389

Battery Box  
Caja de la Bateria  
Boîtier de piles

Other useful accessories that may be purchased separately.  
Otros accesorios útiles que se pueden comprar por separado.  
Autres accessoires utiles pouvant être achetés séparément.

### RP63263

Adapters  
3/8"-24 UNEF to 1/2"-20 UN &  
3/8"-24 UNEF to 1/2"-14 NPSM  
Adaptadors  
3/8"-24 UNEF a 1/2"-20 UN &  
3/8"-24 UNEF a 1/2"-14 NPSM  
Adaptateurs  
3/8 po-24 UNEF à 1/2 po-20 UN et  
3/8 po-24 UNEF à 1/2 po-14 NPSM

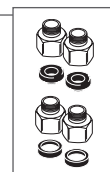

### RP63264

Adapters (10) 3/8"-24 UNEF to 1/2"-20 UN  
Adaptadors (10) 3/8"-24 UNEF a 1/2"-20 UN  
Adaptateurs (10) 3/8 po-24 UNEF à 1/2 po-20 UN

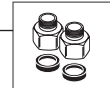

### RP63265

Adapters (10) 3/8"-24 UNEF to 1/2"-14 NPSM  
Adaptadors (10) 3/8"-24 UNEF a 1/2"-14 NPSM  
Adaptateurs (10) 3/8 po-24 UNEF à 1/2 po-14 NPSM

