

Models/Modelos/Modèles
T27899 & T27999

RP91918▲
 Diverter Handle, Set Screw & Button
 Manija desviadora, tornillo de fijación y botón
 Manette de l'inverseur, vis de calage et bouton

RP84972▲
 Set Screw & Button
 Tornillo de fijación y botón
 Vis de calage et bouton

RP84932▲
 Trim Nut
 Tuerca del accesorio
 Écrou de finition

RP84925
 Valve Seal
 Sello de la válvula
 Garniture d'étanchéité

RP84928
 Escutcheon Assembly & Screws
 Ensamble de la chapa y tornillos
 Plaque de finition et vis

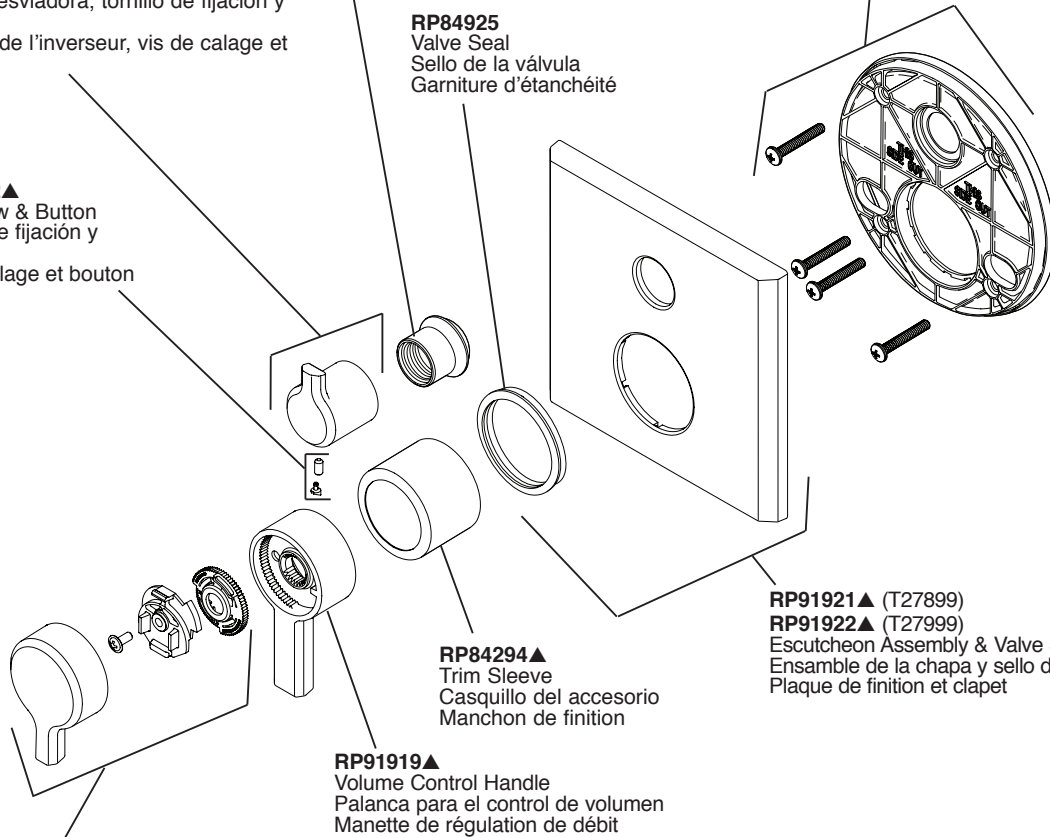

RP91921▲ (T27899)
RP91922▲ (T27999)
 Escutcheon Assembly & Valve Seal
 Ensamble de la chapa y sello de la válvula
 Plaque de finition et clapet

RP84294▲
 Trim Sleeve
 Casquillo del accesorio
 Manchon de finition

RP91919▲
 Volume Control Handle
 Palanca para el control de volumen
 Manette de régulation de débit

RP91920▲
 Temperature Handle, Screw, Limit Stop & Temperature Knob

Manija de la temperatura, tornillo, perilla del tope del límite rotacional

Manette de température, vis, butée de température maximale et bouton de température maximale

RP71717
 2 Function, Non-Shared Diverter Cartridge
 Cartucho desviador no-compartido de 2 funciones
 Cartouche d'inverseur non partage, 2 fonctions

RP51918
 3 Function Cartridge
 Cartucho del desviador, 3 funciones
 Cartouche d'inverseur, 3 fonctions

RP84933
 Sleeve & O-Rings
 Casquillo y juntas tóricas
 Manchon et joints toriques

RP71718
 3 Function, Non-Shared Diverter Cartridge
 Cartucho desviador no-compartido de 3 funciones
 Cartouche d'inverseur non partage, 3 fonctions

RP51919
 6 Function Cartridge
 Cartucho del desviador, 6 funciones
 Cartouche d'inverseur, 6 fonctions

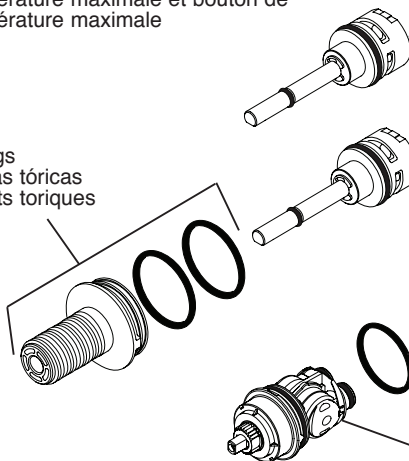

RP23340
 O-Ring
 Junta tórica
 Joint torique

RP46463
 Dual Function Pressure Balance Cartridge
 Cartucho de equilibrio de presión de doble función
 Cartouche double fonction à équilibrage de pression

Model/Modelo/Modèle
R22000
Series/Series/Seria

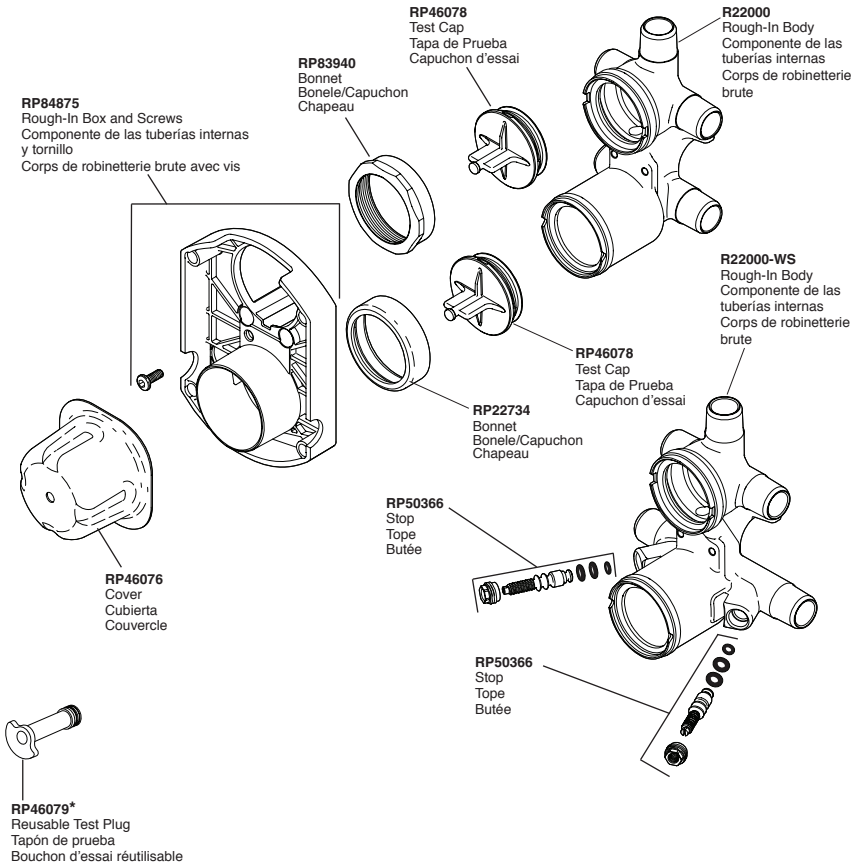

*Used to plug one inlet side (Hot or Cold) to prevent cross flow when checking for leaks before the cartridge is installed. Insert into the inlet, place test cap and use the bonnet to secure in place.

*Tapaban una entrada lateral (caliente o frío) para prevenir flujo cruzado cuando la comprobación para saber si hay escapes antes del cartucho está instalada. El relleno en la entrada, casquillo de la prueba del lugar y utiliza el capo para asegurar en lugar.

*Branchaient une admission latérale (chaud ou froid) pour empêcher l'écoulement en travers quand la vérification les fuites avant la cartouche est installée. L'insertion dans l'admission, chapeau d'essai d'endroit et emploient le capot pour fixer en place.

T50010▲

RP78987
Silicone
Silicona
Siliconé

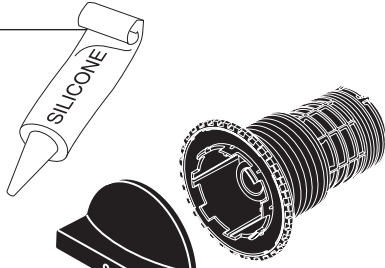

RP79269
Tool
Herramienta
Outil

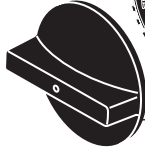

RP77546▲
Escutcheon
Chapa de cubierta
Plaque de finition

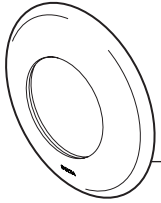

▲ Specify Finish / Especificque el Acabado / Précisez le fini

T50210▲

RP78987
Silicone
Silicona
Siliconé

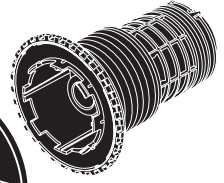

RP79269
Tool
Herramienta
Outil



RP77548▲
Escutcheon
Chapa de cubierta
Plaque de finition

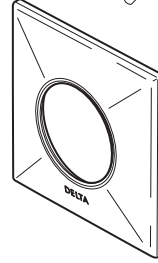

▲ Specify Finish / Especificque el Acabado / Précisez le fini

SH84100▲
SH5003▲

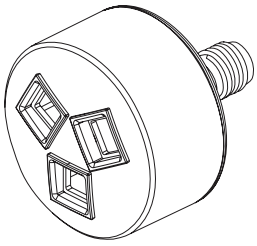

SH84101▲
SH5005▲

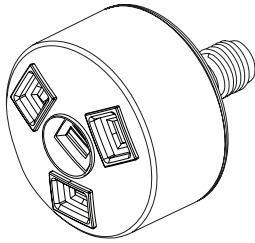

SH84102▲
SH5002▲

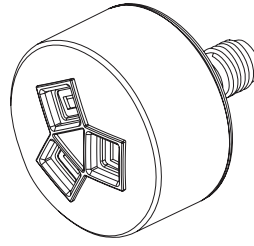

SH84103▲
SH5000▲

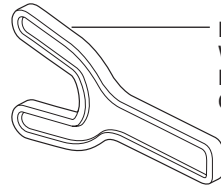
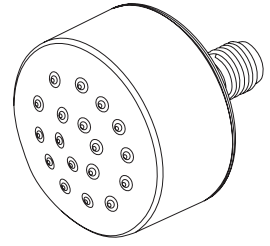

RP77544
Wrench
Llave
Clé

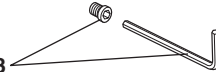

RP77543
Set Screw & Wrench
Tornillo de Ajuste y Llave
Vis de calage et clé