

T27867, T27967 Models / Modelos / Modèles

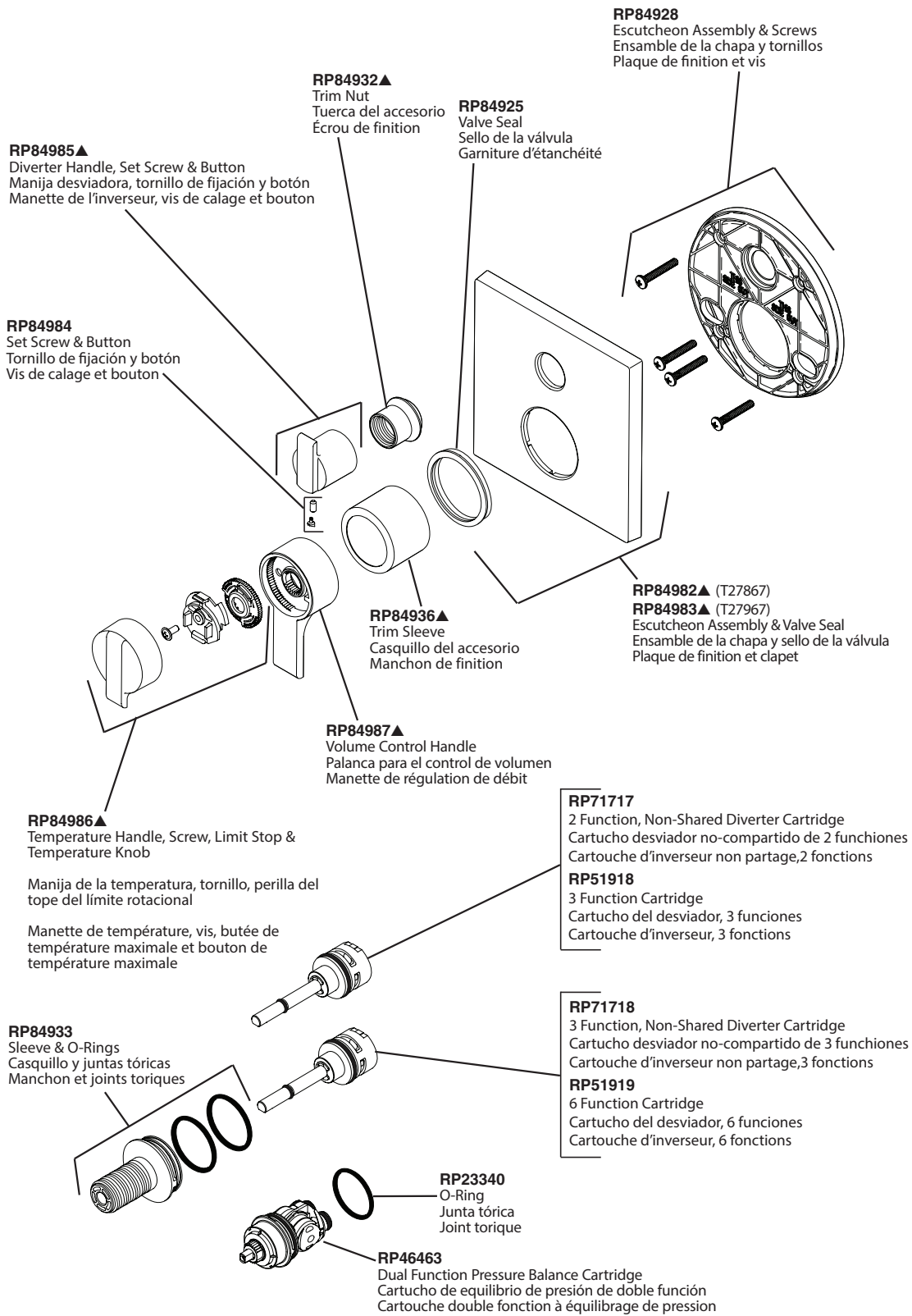

▲ Specify Finish/Especifique el Acabado/ Précisez le fini

RP90543

Thick Wall Installation Kit

Juego de piezas para la instalación en paredes gruesas

Trousse d'installation pour mur épais

For finished wall thickness over 1 1/8" up to 2 1/8" (Order Separately)

Para paredes acabadas de un grosor mayor de 1 1/8" hasta 2 1/8" (ordene por separado)

Installation dans un mur fini d'une épaisseur de 1 1/8 po à 2 1/8 po (commandez séparément)

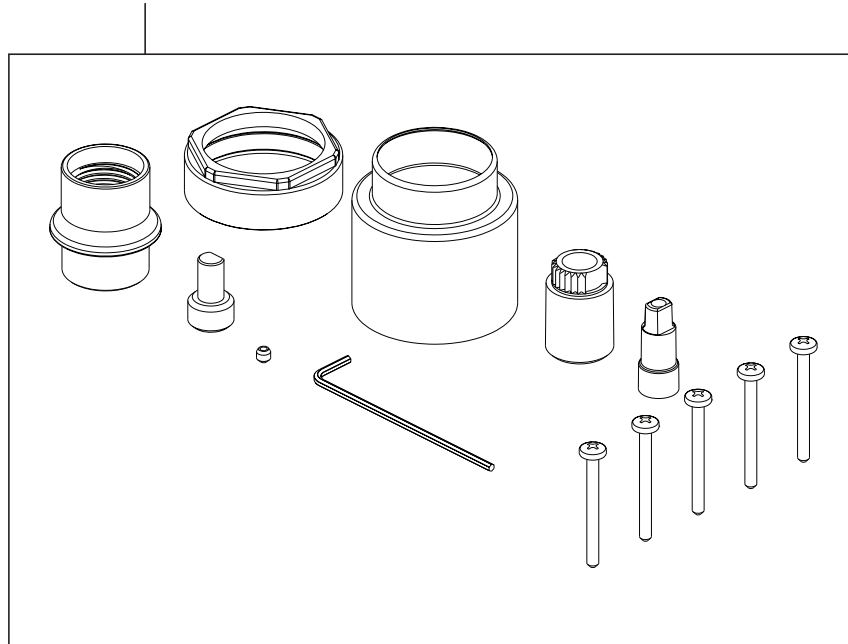

Model/Modelo/Modèle
R22000
Series/Series/Seria



*Used to plug one inlet side (Hot or Cold) to prevent cross flow when checking for leaks before the cartridge is installed. Insert into the inlet, place test cap and use the bonnet to secure in place.

*Tapaban una entrada lateral (caliente o frío) para prevenir flujo cruzado cuando la comprobación para saber si hay escapes antes del cartucho está instalada. El relleno en la entrada, casquillo de la prueba del lugar y utiliza el capo para asegurar en lugar.

*Branchaient une admission latérale (chaud ou froid) pour empêcher l'écoulement en travers quand la vérification les fuites avant la cartouche est installée. L'insertion dans l'admission, chapeau d'essai d'endroit et emploient le capot pour fixer en place.

T50010▲

RP78987
Silicone
Silicona
Siliconé

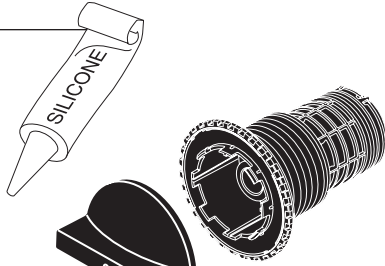

RP79269
Tool
Herramienta
Outil

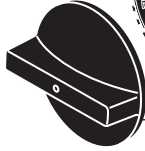

RP77546▲
Escutcheon
Chapa de cubierta
Plaque de finition

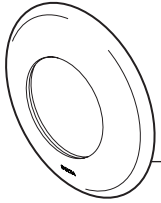

▲ Specify Finish / Especificque el Acabado / Précisez le fini

T50210▲

RP78987
Silicone
Silicona
Siliconé

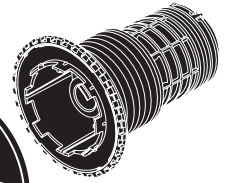

RP79269
Tool
Herramienta
Outil



RP77548▲
Escutcheon
Chapa de cubierta
Plaque de finition

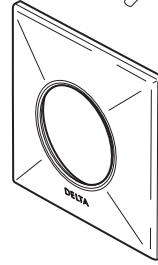

▲ Specify Finish / Especificque el Acabado / Précisez le fini

SH84100▲
SH5003▲

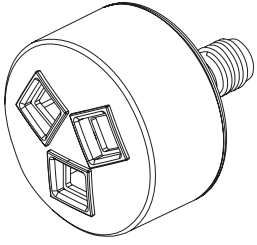

SH84101▲
SH5005▲

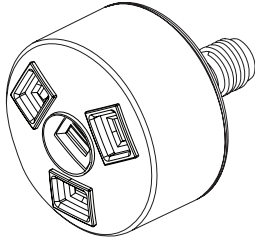

SH84102▲
SH5002▲

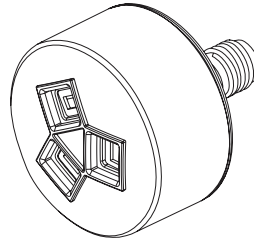

SH84103▲
SH5000▲

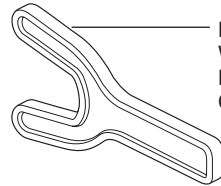
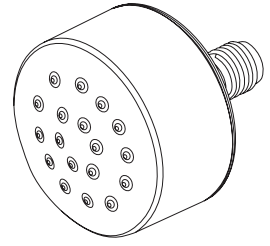

RP77544
Wrench
Llave
Clé

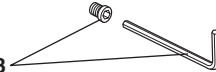

RP77543
Set Screw & Wrench
Tornillo de Ajuste y Llave
Vis de calage et clé