

Cast Centerset Faucets 4" Centers

TECK®

DELTA
COMMERCIAL

Specification: (example)

- **HEAVY DUTY CAST BRASS** centerset faucet
 - 102mm (4") centers, two handle
 - Polished chrome plated finish with polished underspout
 - Metal hold-down package
 - Color indexed metal handles with vandal resistant screws
- and ... with ... (add **CER-TECK®** 1/4 turn ceramic structures or **TUF-TECK®** compression structures)
- with ... (add product variation required)
- with ... (add outlet required)
- with ... (add handle required)
- with ... (add suffix **-TI** if required - See Back Page)

Synergy®



21C143
21T143



21C144
21T144

Engineer/Architect Approval

















Model Specified:

Approval:

Date:

DESCRIPTION	PRODUCT NO.			
	CER-TECK®	21C		
4" Centerset Faucet	TUF-TECK®	21T		



PRODUCT VARIATION	OUTLET	HANDLE
0 <input type="checkbox"/>	0 <input type="checkbox"/>	0 <input type="checkbox"/>
1 Standard Product Less Pop-up (No Pop-up Hole) <input type="checkbox"/> 	1 Vandal Resistant 1.9 USGPM (7.2 L/min.) Flow Control Rosespray <input type="checkbox"/> 	1 Five Flute Handles <input type="checkbox"/> 
2 Standard Product With Metal Pop-up <input type="checkbox"/> 	2 Vandal Resistant 1.5 USGPM (5.7 L/min.) Laminar w/Agion® Antimicrobial <input type="checkbox"/> 	2 102mm (4") Hooded Blade Handles (1) <input type="checkbox"/> 
3 Standard Product with Cast Open Grid Strainer (No Pop-up Hole) <input type="checkbox"/> 	3 Vandal Resistant 1.5 USGPM (5.7 L/min.) Flow Control Aerator <input type="checkbox"/> 	3 76mm (3") Lever Blade Handles (1) <input type="checkbox"/> 
4 Standard Product With Cast Offset Open Grid Strainer (No Pop-up Hole) <input type="checkbox"/> 	4 Standard 1.5 USGPM (5.7 L/min.) Flow Control Aerator <input type="checkbox"/> 	4 102mm (4") Blade Handles, Sanitary Hoods (1) <input type="checkbox"/> 
5 Standard Product With Chain Stay Less Plug & Chain <input type="checkbox"/> 	5 Vandal Resistant 0.5 USGPM (1.9 L/min.) Flow Control Non-Aerating Spray Outlet <input type="checkbox"/> 	5 152mm (6") Wrist Handles, Sanitary Hoods <input type="checkbox"/> 
6 <input type="checkbox"/>	6 <input type="checkbox"/>	6 <input type="checkbox"/>
7 <input type="checkbox"/>	7 <input type="checkbox"/>	7 <input type="checkbox"/>
8 <input type="checkbox"/>	8 <input type="checkbox"/>	8 76mm (3") Self-Closing Lever Blade Handles <input type="checkbox"/> 
9 <input type="checkbox"/>	9 <input type="checkbox"/>	9 Five Flute Self-Closing Handles <input type="checkbox"/> 

See Series 27C4, 27C5, 27T4, & 27T5 for 4" Gooseneck Spout Centersets.

Refer to www.specselect.com for individual models.

(1) H & C Temperature Indicator available. Add suffix **-TI**.

Delta reserves the right (1) to make changes in specifications and materials, and (2) to change or discontinue models, both without notice or obligation. Dimensions are for reference only. See current full-line price book or www.specselect.com for finish options and product availability.

Flowrates are at 60 PSI.

Note: Use this page front and back as a product submittal sheet.

Approvals:

- CSA certified
- Complies to ASME A112.18.1
- Lever Blade Handle No. 2, 3, 4 and 5, ADA Compliant and meet Handicapped Accessibility Standard ASME A117.1 of less than 5 lbs. operating force.
- IAPMO listed

(Contact Delta Representative for State and/or Local Approvals.)

HANDLE TEMPERATURE INDICATORS

- Add suffix **"-TI"** to Product Number for handle temperature indicators "H" (red), "C" (blue). Available on handle options 2, 3 or 4 only.



FLOWRATE vs PRESSURE

Outlet Flowrates

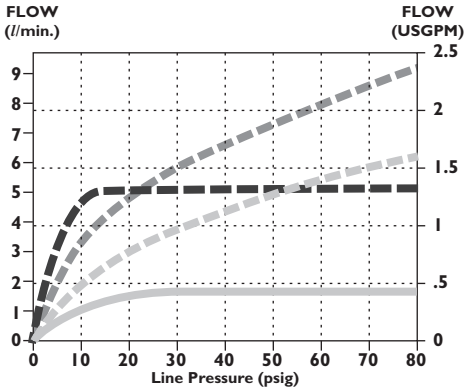

Spout Outlets

- No. 0 Aerator
- No. 2 Laminar Flow Outlet
- No. 3 & 4 Aerator
- No. 5 Low Flow Outlet

CAST SPOUT OUTLET NO.	"D"	
	mm	in.
1	19	0.75
2	11	0.45
3	11	0.45
4	11	0.45
5	11	0.45

INLETS - 1/2" MIP/Coupling Nuts

Note: Measurements may vary ± 6mm (0.25")

Refer to www.specselect.com for individual models.

FRONT VIEW

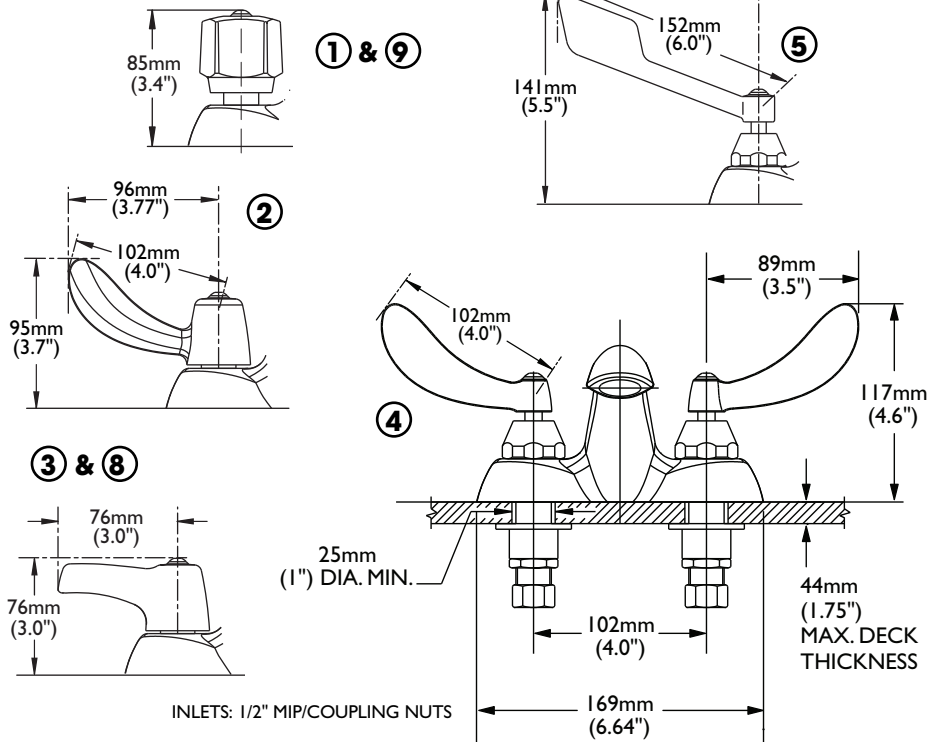

SIDE VIEW

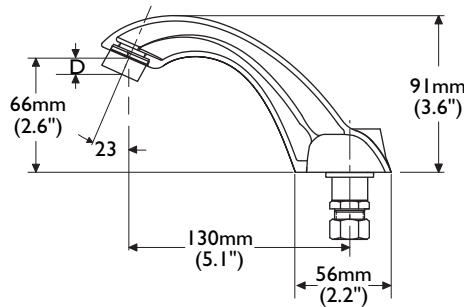

OPEN GRID STRAINER (supplied with Product Variation 3)

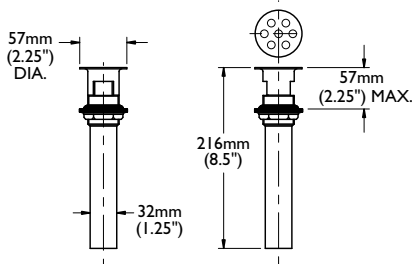

METAL POP-UP (supplied with Product Variation 2)

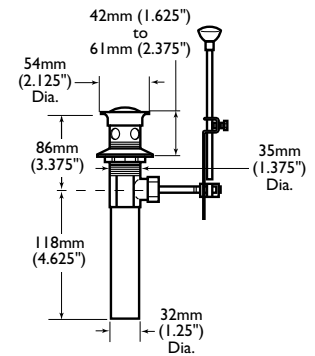

OFFSET OPEN GRID STRAINER (supplied with Product Variation 4)

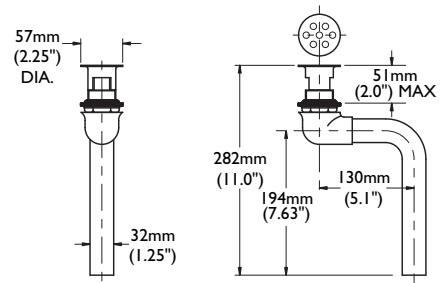

Note: Use this page front and back as a product submittal sheet.