

Model No. C2SL36



Features:

- Three high performance Coyote Infinity Burners™
- One infrared rear burner
- One Coyote RapidSear™ infrared burner
- 875 sq. in. cooking area
- Up to 90,000 BTU
- Ceramic Flavorizers
- Complete 304 stainless steel construction
- Interior grill lighting
- LED illuminated knobs
- Rotisserie kit and smoker box included
- Integrated wind guard

Dimensions:

- Cutout: (H) 10 1/4" X (W) 32 1/2" X (D) 20 1/2"
- Overall: (H) 23" X (W) 35 1/2" X (D) 25 1/2"

Accessories:

- Laser-Cut Signature Grates (CSIGRATE12)
- Charcoal trays (CCHTRAY12)
- 14" stainless steel griddle (C1GRDL)
- Stainless steel cart (C1S36CT)
- Custom fit, weather resistant cover
- Insulated jacket
- Gas conversion kit

C2SL36 PRODUCT SPECS

DIMENSIONAL RENDERINGS

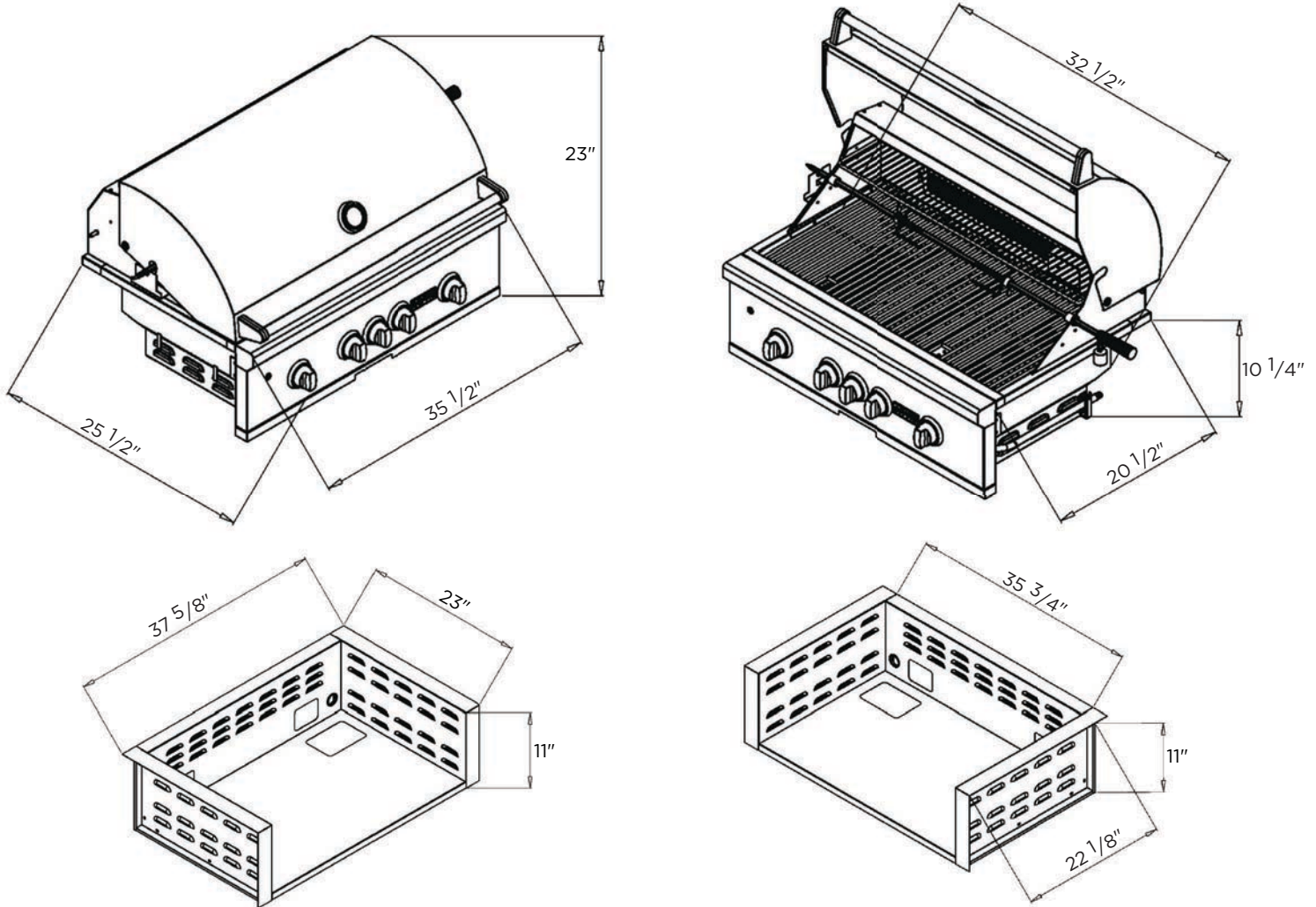

Overall Product Dimensions			
Model No.	Height	Width	Depth
C2SL36	23"	35 1/2"	25 1/2"
CJAKTCS36	11"	37 5/8"	23"

Cutout Dimensions for Island			
Model No.	Height	Width	Depth
C2SL36	10 1/4"	32 1/2"	20 1/2"
CJAKTCS36	11"	35 3/4"	22 1/8"

✓ When using a Coyote insulated jacket, you will want to build your island to the jackets Cutout and Overall Dimensions listed above. Once the jacket is installed, the grill will rest on/inside the insulated jacket

Model No.	Gas Supply	BTU's	Regulator	WC Pressure	Max PSI	Electrical Requirements
C2SL36LP	Propane	90,000	20 lb Tank Regulator	11"	.5 PSI	Qty 1 - 120 VAC 60 Hz Grounded Plug
C2SL36NG	Natural Gas	90,000	1/2" Female Pipe	4"	.5 PSI	Qty 1 - 120 VAC 60 Hz Grounded Plug

Important Note to Installer: This file is not intended to replace your Owners' Manual which contains specific safety requirements and consumer guidelines. Please refer to your Owners' Manual prior to installing or operating your built-in grill.