

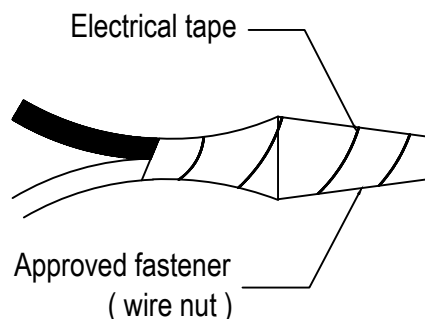

WARNING

The use of chain pliers for opening and closing links of chain is required. The use of tools other than chain pliers may damage the chain link resulting in a failure which can cause harm to the fixture, property, and/or person(s).

4. Thread the lead wire and ground wire (first) through the threaded ring, then the canopy and up through alternating links of the chain until the ceiling is reached.
5. Measure 6" of lead and ground wire beyond the top of the chain out of the excess wire. Strip the insulation off the ends of the leads, exposing approximately $\frac{1}{2}$ " of wire. Twist the stands of wire together. Push the leads and ground wire up through the screwcollar loop and into the outlet box.
6. Fasten the ground wire to the green or bare copper wire in the outlet box or to the green screw on the crossbar.



WARNING

Never fasten the ground wire to the black or "hot" wire!
Failure to follow this instruction could result in serious injury or death!

7. Fasten the fixture lead with the ridge(s) to the white wire in the outlet box. Fasten the wires together with an approved fastener (wire nut) Starting about 1" below the fastener, tightly wrap the connection with electrical tape so that the tape seals the end of the fastener.



WARNING

Make sure that there is no exposed wire or strands that could cause a dangerous short circuit!

8. Connect the smooth fixture lead to the black wire in the outlet box. Fasten the joined wires as in step 7.
9. Slide the canopy and screw collar ring up the chain and secure the canopy to the ceiling.

NOTICE:

If the fixture is being installed in a room with a hard floor (tile, wood, etc.), place a blanket or carpet below the fixture before installing the crystal trimming.

10. Install the lamps (lighting bulbs). NOTE: This fixture is rated for candelabra based, 60 watt type B, BA, C, or CA lamps.



WARNING

DO NOT EXCEED RECOMMENDED WATTAGE!

11. Hang the crystal strands following the crystal schedule.
12. Restore power to circuit at breaker or fuse box.

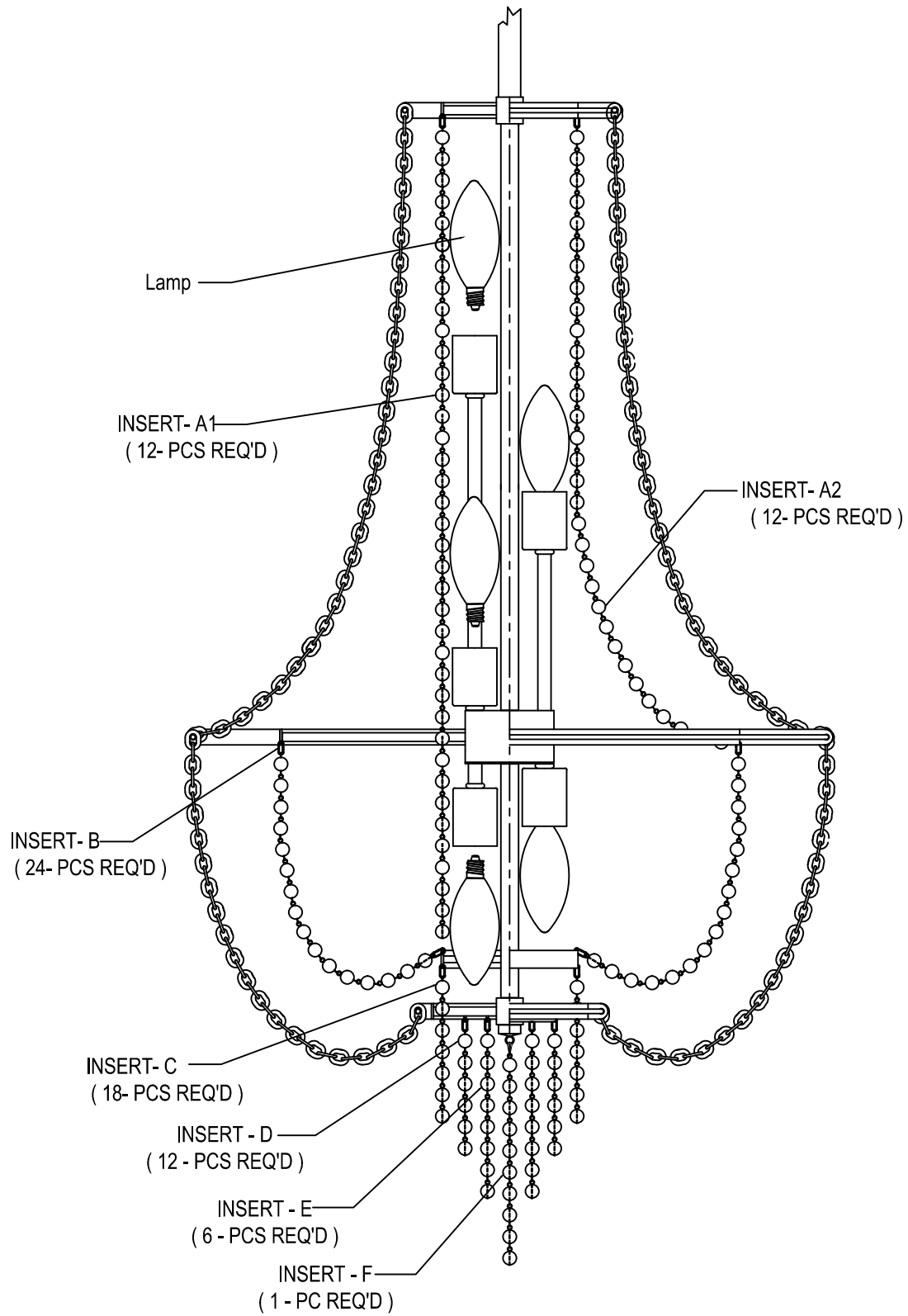

Top view

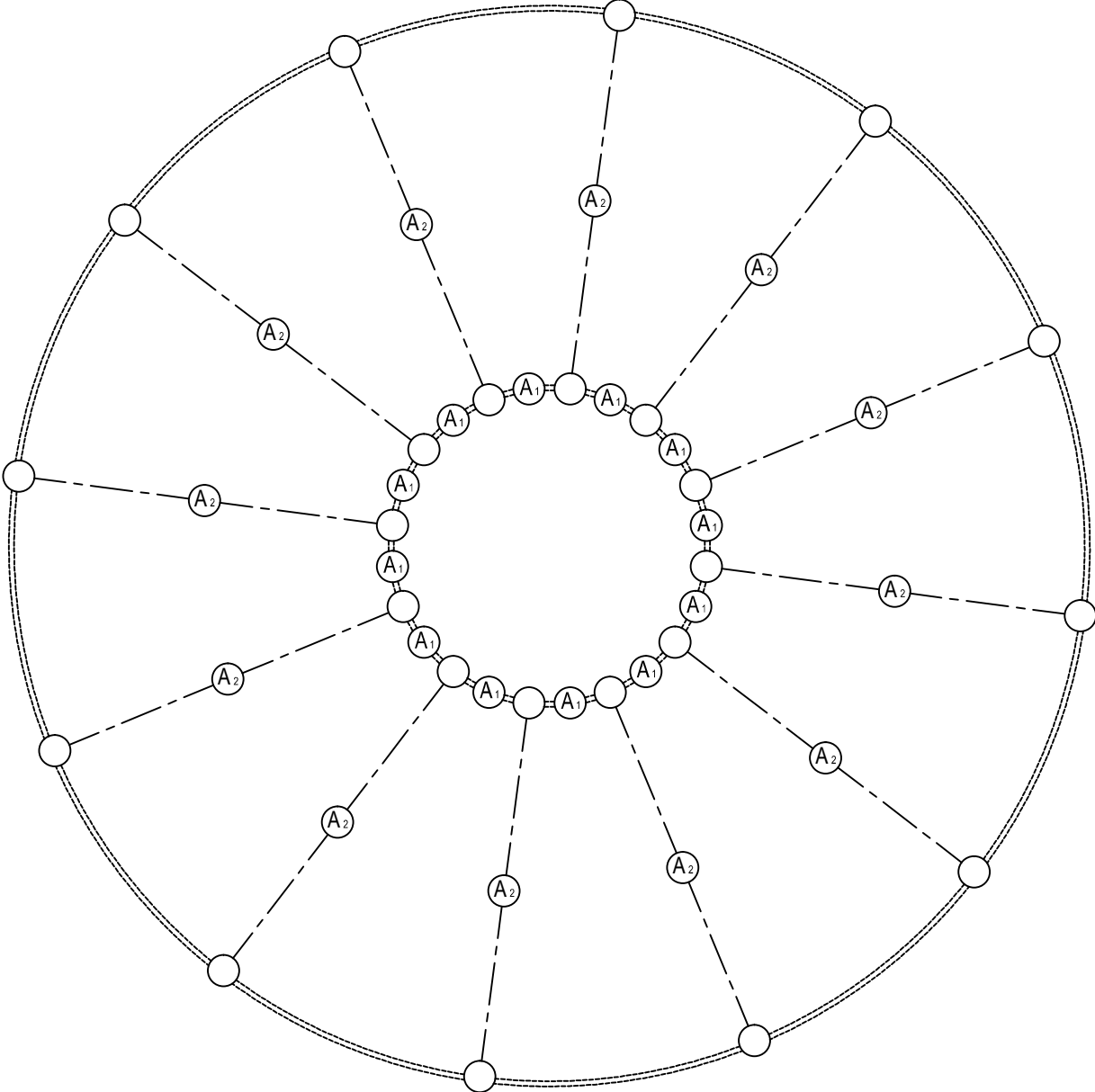

Crystal schedule

141-45 CRYSTAL INSTALLATION INSTRUCTION

Bottom view

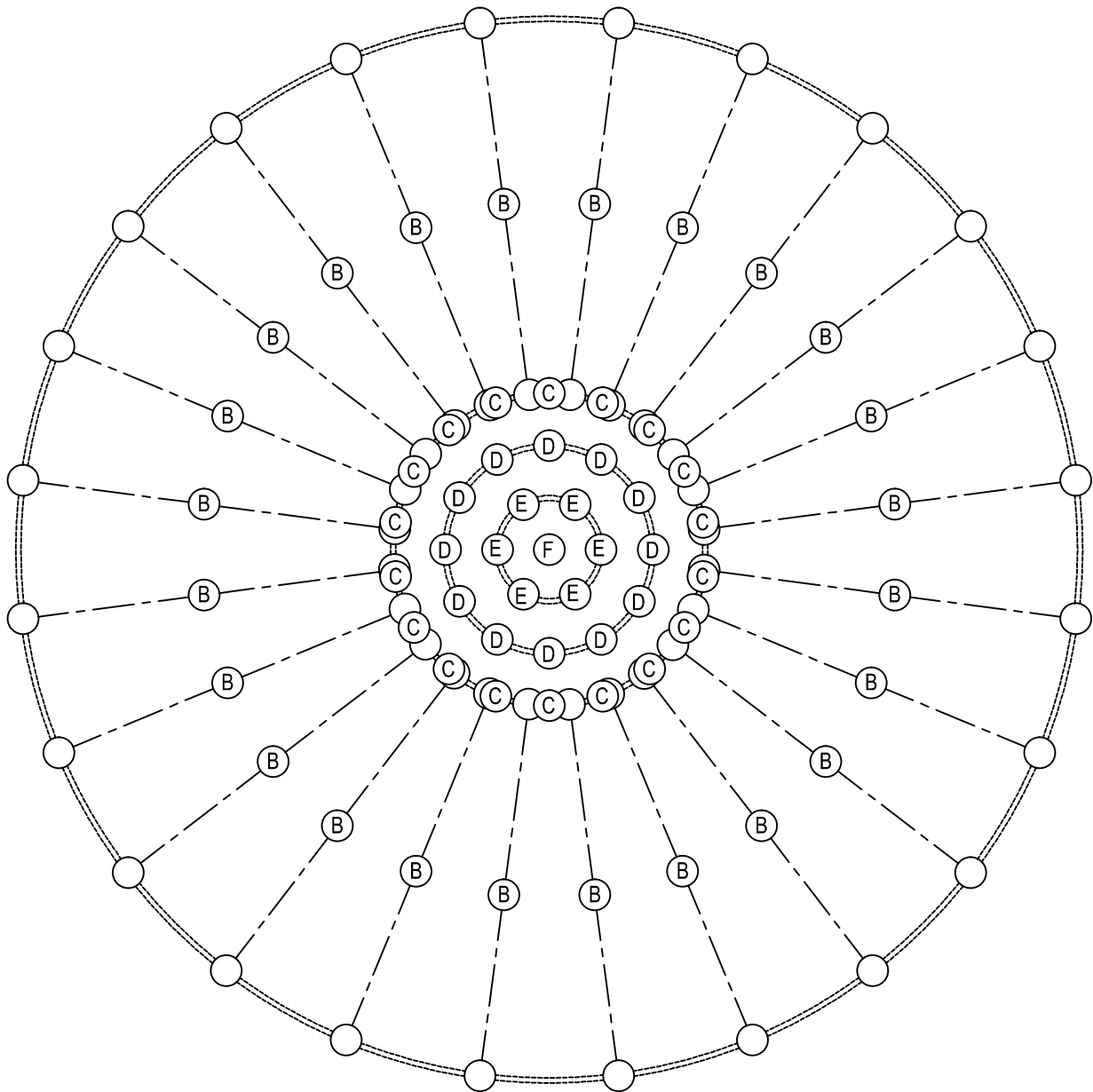

Crystal schedule

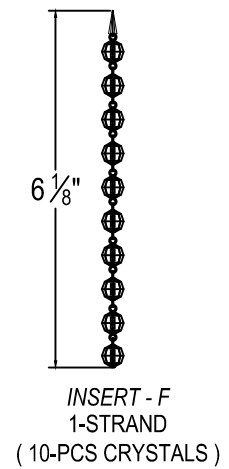
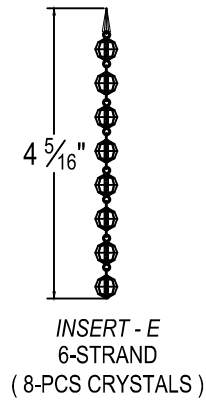
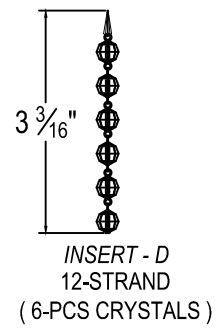
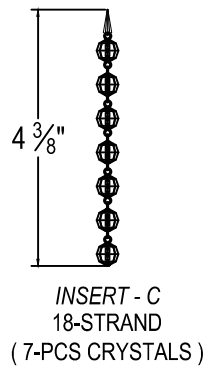
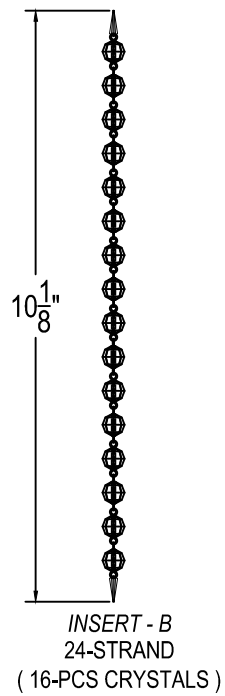
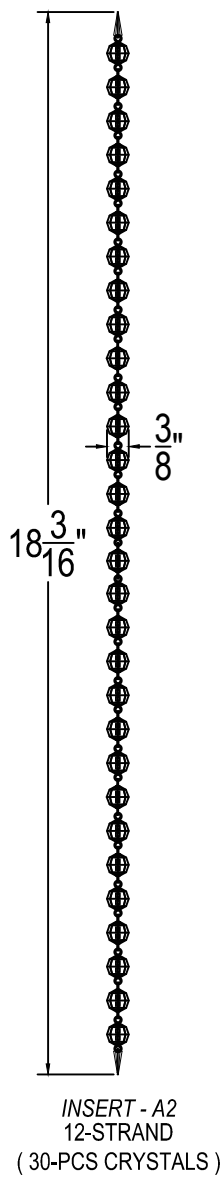
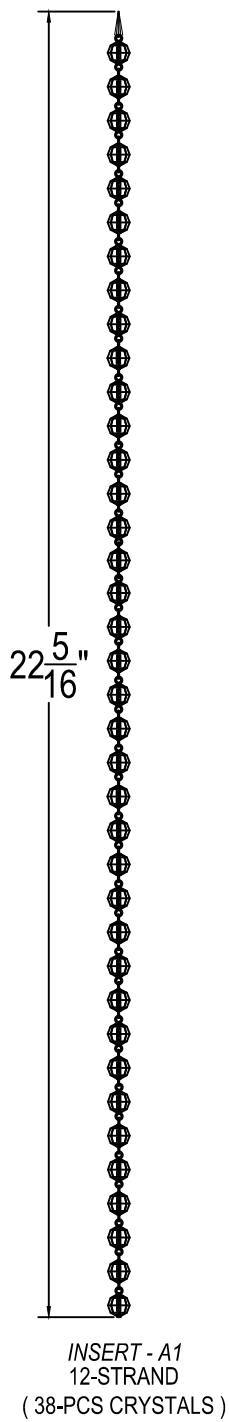

141-45 CRYSTAL INSTALLATION INSTRUCTION

141-45 VIXEN 6-LTS. ENTRY INSTALLATION INSTRUCTIONS



WARNING

**DISCONNECT POWER BEFORE RELAMPING OR WIRING THE FIXTURE
READ ALL INSTRUCTIONS COMPLETELY BEFORE STARTING INSTALLATION.**



CAUTION

- TO AVOID THE RISK OF FIRE OR SHOCK, FIXTURE MUST BE INSTALLED IN COMPLIANCE WITH ALL APPLICABLE NATIONAL AND LOCAL ELECTRICAL/BUILDING CODES.
- INSTALLATION AND MAINTENANCE OF THIS UNIT REQUIRES AN ELECTRICIAN OR CERTIFIED FACTORY TRAINED TECHNICIAN.
- If an existing fixture is being replaced, remove it and note to which of the wires in the outlet box the fixture was attached. DO NOT SEPARATE ANY OTHER WIRES THAT MAY BE IN THE BOX. DO NOT DAMAGE THE INSULATION OF OLDER WIRING. In regular circumstances the BLACK wire will be the "Hot" lead and the WHITE wire will be the "Neutral" or "Common" lead A GREEN or BARE COPPER wire is the "Ground". In older buildings it is always good practice to reconfirm the polarity of the wiring .

NOTICE

- The important safeguards and instructions outlined on this sheet cannot cover all possible conditions and situations that may occur. It must be understood that common sense, caution and care factors that cannot be built into any product. Caution and care must be supplied by the person(s) installing, operating and caring of this lighting fixture.
- This fixture is design to be mounted on a correctly installed standard round or octagon box or a through wiring box with a plaster frame. The box must be securely mounted to the structure of the building. The crossbar and hardware supplied should be used. Directly mounting the fixture to the outlet box may make it impossible to correctly align the fixture.

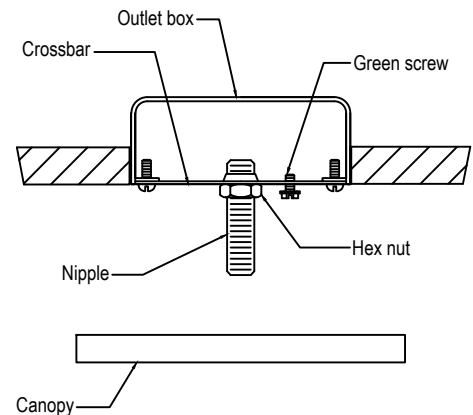

FIXTURE PREPARATION

1. Remove the fixture, crystals and parts bag(s) from the carton.

NOTICE:

**Before discarding the carton,
double check to make certain that all parts are found .**

FIXTURE INSTALLATION

1. Attach the crossbar to the outlet box. (The green screw should face the floor).
2. Remove the threaded ring from the screwcollar loop. Fully thread the screwcollar loop onto the nipple. Thread the hex nut onto the nipple and the nipple into the crossbar. Place the canopy over the screwcollar and against the ceiling/ Adjust the nipple so that $\frac{1}{4}$ " of the threads on the screwcollar loop extend beyond the canopy. Tighten the hex nut against the crossbar. Using the threaded ring, install the canopy.
3. Open the end links of the chain and attach the chain to the screwcollar loop. Hang the fixture on the chain at the desired height. Remove the excess chain close all links. Unscrew the threaded ring from the screwcollar loop. Allow the ring and canopy to side down the chain to the top of the fixture.

