

⚠ WARNING
DISCONNECT POWER BEFORE RELAMPING OR WIRING THE FIXTURE.
READ ALL INSTRUCTIONS COMPLETELY BEFORE STARTING INSTALLATION.

⚠ CAUTION

- TO AVOID THE RISK OF FIRE OR SHOCK, FIXTURE MUST BE INSTALLED IN COMPLIANCE WITH ALL APPLICABLE NATIONAL AND LOCAL ELECTRICAL/BUILDING CODES.
- INSTALLATION AND MAINTENANCE OF THIS UNIT REQUIRES AN ELECTRICIAN OR CERTIFIED FACTORY TRAINED TECHNICIAN.
- If an existing fixture is being replaced, remove it and note to which of the wires in the outlet box the fixture was attached. DO NOT SEPARATE ANY OTHER WIRES THAT MAY BE IN THE BOX. DO NOT DAMAGE THE INSULATION OF OLDER WIRING. In regular circumstances the BLACK wire will be the “Hot” lead and the WHITE wire will be the “Neutral” or “Common” lead. A GREEN or BARE COPPER wire is the “Ground”. In older buildings, it is always good practice to reconfirm the polarity of the wiring.

NOTICE

- The important safeguards and instructions outlined on this sheet cannot cover all possible conditions and situations that may occur. It must be understood that common sense, caution and care are factors that cannot be built into any product. Caution and care must be supplied by the person(s) installing, operating and caring for this lighting fixture.
- This fixture is designed to be mounted on a correctly installed standard round or octagon box or a through wiring box with a plaster frame. The box must be securely mounted to the structure of the building. The crossbar and hardware supplied should be used. Directly mounting the fixture to the outlet box may make it impossible to correctly align the fixture.

FIXTURE PREPARATION

1. Remove the fixture and parts bag(s) from the carton.

NOTICE:
Before discarding the carton, double check the contents to make certain that all parts are found.

FIXTURE INSTALLATION

1. Determine the overall desired length of the fixture. Assemble the stems one at a time onto the fixture leads. Tape the ends of the leads to a stiff wire (coat hanger) to aid in pulling them through the stems.

NOTICE:
Place the canopy onto stem BEFORE assembling the top stem section and swivel.

2. Attach the mounting ring to the outlet box. (The green screw should face the floor.) Back out the screws 1/2 turn to allow the ring to rotate.
3. Thread the studs into the mounting ring at the spacing that matches the mounting holes in the canopy. Adjust the screws so they extend 3/16" beyond the canopy.
4. Cut off the excess ground and fixture wire 6" beyond the canopy. Strip 1/2 " of insulation from the ends of the wire. Twist the wire strands together.
5. Fasten the ground wire to the green or bare copper wire in the outlet box or the green screw on the crossbar.

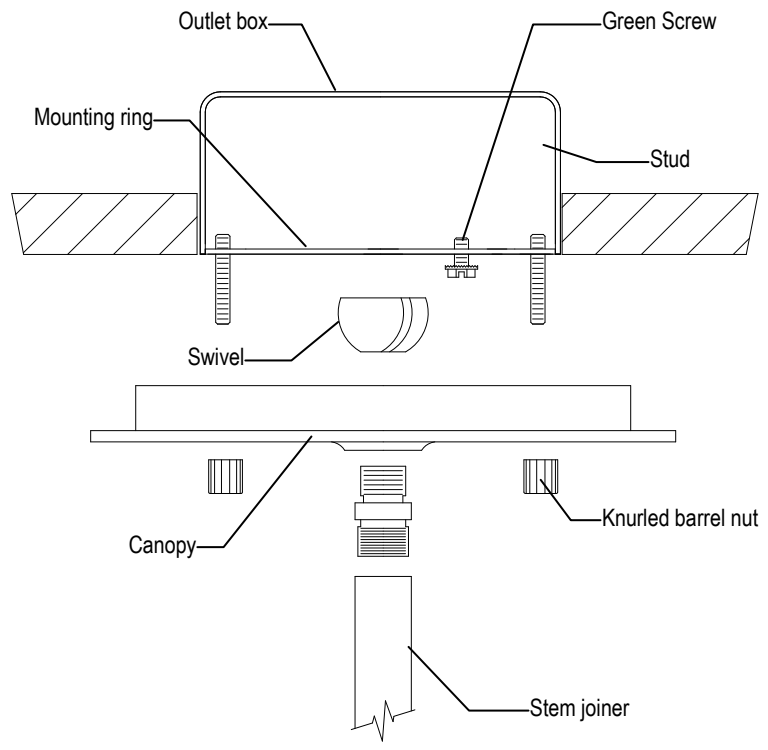



WARNING

**Never fasten the ground wire to the black or "hot" wire!
Failure to follow this instruction could result in serious injury or death!**

- 6. Fasten the white fixture lead to the white wire in the outlet box. Fasten the wires together with an approved fastener (wire nut). Starting about 1" below the fastener, tightly wrap the connection with electrical tape so that the tape seals the end of the fastener.

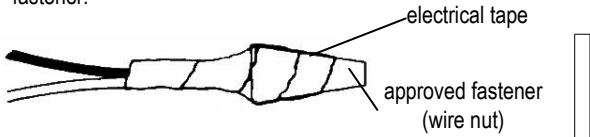

WARNING

Make sure that there is no exposed wire or strands that could cause a dangerous short circuit!

- 7. Connect the black fixture lead to the black wire in the outlet box. Fasten the joined wires as in step 6.
- 8. Using the knurled barrel nuts, loosely fasten the fixture to the outlet box. Rotate and align the canopy as necessary. Tighten the knurled barrel nuts.

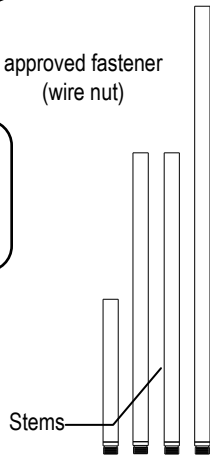

- 9. Remove the knurled screws on the frame at the bottom of the fixture. Turn the ring counterclockwise to unlatch it from the bottom of the fixture.

- 10. Remove the frame and diffuser.

- 11. Install the lamps (light bulbs).
NOTE: This fixture is rated for 60 watt medium based, type A lamps.



WARNING

**DO NOT EXCEED RECOMMENDED WATTAGE!
For saving energy, 12 watt spiral fluorescent lamps may be used.**

- 12. Reinstall the diffuser cylinder and frame. Reinstall the screws.
- 13. Install the corner panels. Insert the pins on the top edge of the panel into the matching holes in the fixture frame. Lift the panel up to allow the lower pins to clear the frame. Insert the lower pins into the frame. Push the panel down into final position.
- 14. Install the middle panels following step 13.
- 15. Restore power to circuit at breaker or fuse box.

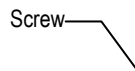
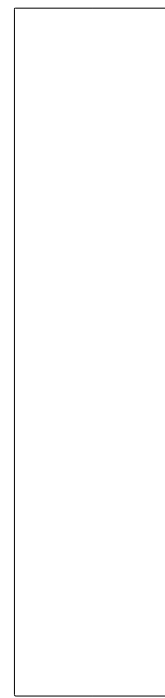
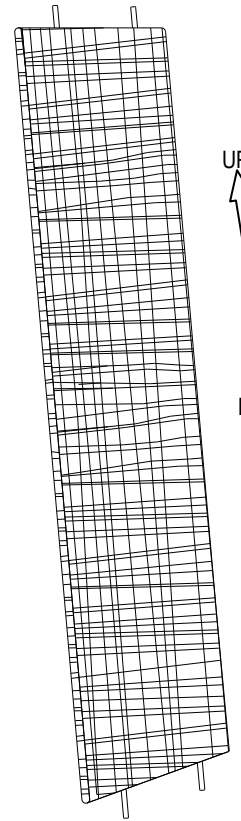
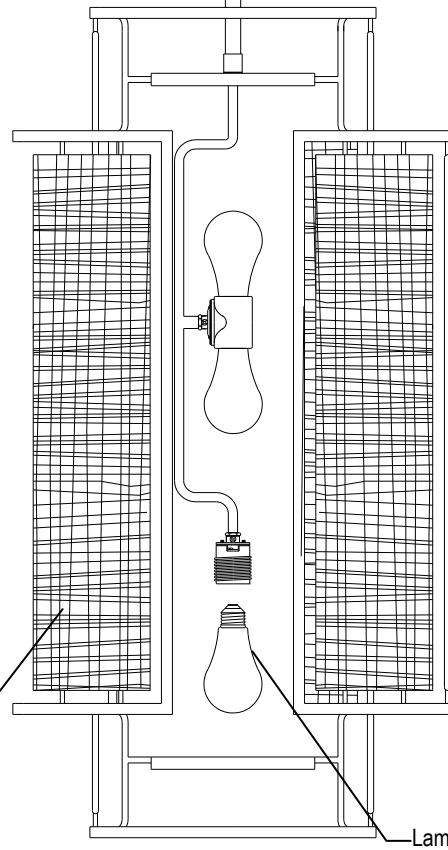
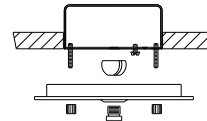

NOTE: 105-74 Shown