

INSTRUCTION FOR INSTALLATION OF LOCKSETS

1. MARK DOOR

Mark center of door edge and center hole on door face through guide on template. (Backset 60mm fitting all doors from 35mm to 45mm thickness).

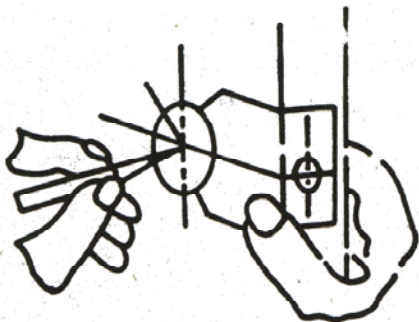

2. DRILL TWO HOLES AND INSTALL LATCH

Drill 53mm hole through door face as marked for lockset and 23mm hole in center of door edge for latch. Make sure the hole for latch can be inserted right into the door edge. Then chisel a small place until latch face is flush with door edge.

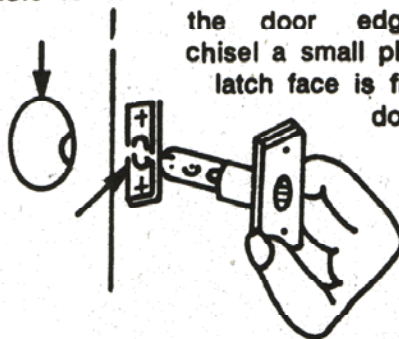

3. INSTALL STRIKE

Install strike as illustrated and make sure it is set to the same height as the latch.

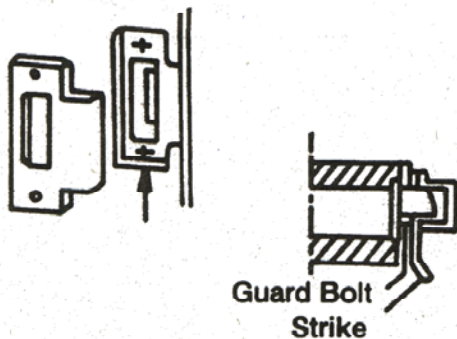

4. INSTALL EXTERIOR KNOB

Install knob with spindle into latch making certain that stems are positioned correctly through latch hole. Press flush against door.

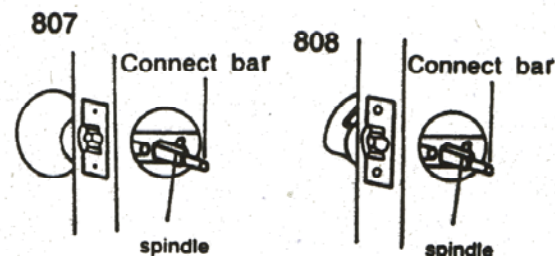

5. INSTALL INTERIOR LEVER

Turn interior lever so that assembly and rose can be placed on spindle (The knob must be placed in same level with Connect bar). Tighten screws.

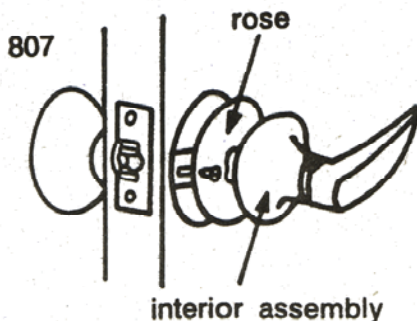

5. INSTALL INTERIOR LEVER

Turn interior lever so that assembly and rose can be placed on spindle (The lever must be placed in same level with Connect bar). Tighten screws.

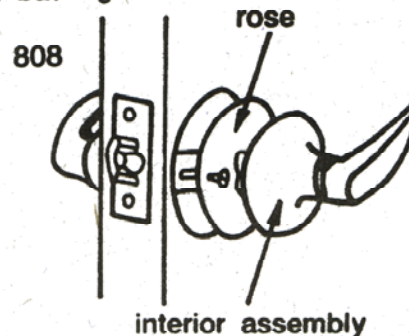

6. CHANGE LOCK HAND

If key hole is placed in erroneous position depress retainer and slide knob off. Turn exterior knob 180° and replace knob back.

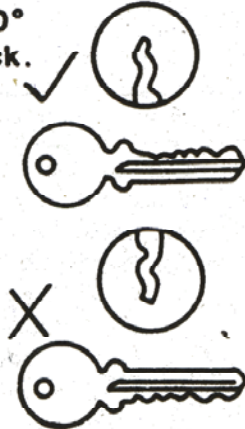

7. ACCESSORIES

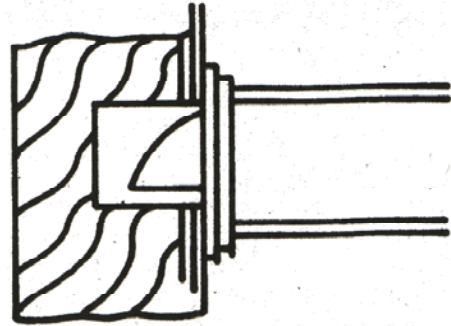

Install the strike and strike box in the proper position symmetric with the latch

8. OPENING TEST

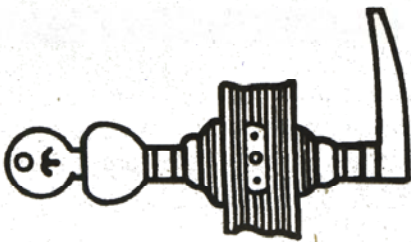

807

For checking a proper intallation just insert the key and turn both exterior knob interior lever.

8. OPENING TEST

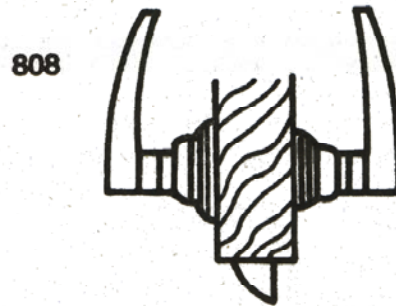

For checking a proper intallation just turn both exterior and interior levers.

PAPER MARKER

