

LED SCONCE

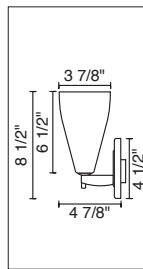

ZARA SCONCE
102 151(bz,ch,mc)
102 152(bz,ch,mc)
102 153(bz,ch,mc)
102 154(bz,ch,mc)
102 156(bz,ch,mc)
102 157(bz,ch,mc)

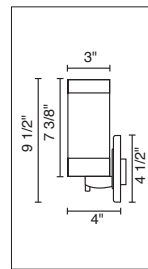

SILVA SCONCE
102 711(bz,ch,mc)
102 712(bz,ch,mc)
102 713(bz,ch,mc)
102 714(bz,ch,mc)
102 715(bz,ch,mc)
102 716(bz,ch,mc)

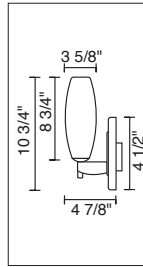

CIRO SCONCE
102 116(bz,ch,mc)
102 119(bz,ch,mc)
102 121(bz,ch,mc)
102 122(bz,ch,mc)
102 123(bz,ch,mc)
102 124(bz,ch,mc)
102 125(bz,ch,mc)

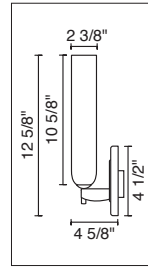

CHIANTI SCONCE
102 820(bz,ch,mc)
102 821(bz,ch,mc)
102 822(bz,ch,mc)
102 823(bz,ch,mc)

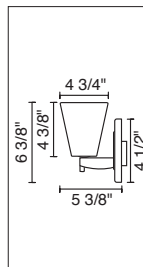

BLING I SCONCE
102 168(bz,ch,mc)
102 173(bz,ch,mc)
102 178(bz,ch,mc)
102 840(bz,ch,mc)
102 841(bz,ch,mc)
102 842(bz,ch,mc)

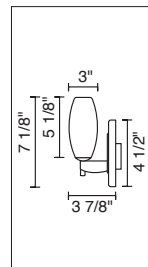

CIRO MINI SCONCE
102 830(bz,ch,mc)
102 831(bz,ch,mc)
102 832(bz,ch,mc)
102 833(bz,ch,mc)

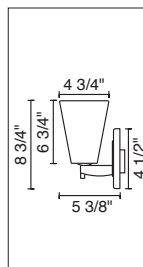

BLING II SCONCE
102 169(bz,ch,mc)
102 174(bz,ch,mc)
102 179(bz,ch,mc)
102 843(bz,ch,mc)
102 844(bz,ch,mc)
102 845(bz,ch,mc)

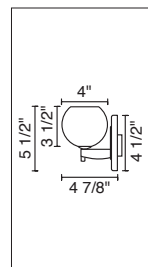

BOBO SCONCE
102 915(bz,ch,mc)
102 917(bz,ch,mc)

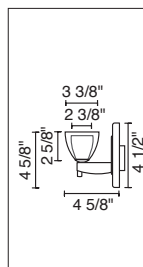

RAINBOW I SCONCE
102 721(bz,ch,mc)
102 722(bz,ch,mc)
102 723(bz,ch,mc)
102 724(bz,ch,mc)
102 913(bz,ch,mc)
102 918(bz,ch,mc)

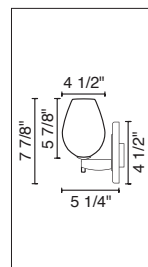

BOLERO SCONCE
102 336(bz,ch,mc)
102 337(bz,ch,mc)
102 338(bz,ch,mc)
102 339(bz,ch,mc)

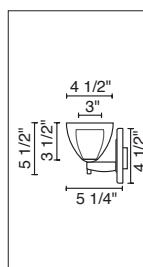

RAINBOW II SCONCE
102 725(bz,ch,mc)
102 726(bz,ch,mc)
102 728(bz,ch,mc)
102 729(bz,ch,mc)
102 816(bz,ch,mc)
102 817(bz,ch,mc)
102 916(bz,ch,mc)
102 919(bz,ch,mc)

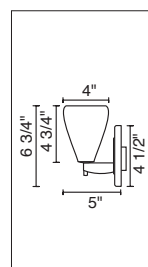

LUCY SCONCE
102 126(bz,ch,mc)
102 127(bz,ch,mc)
102 128(bz,ch,mc)

LED SCONCE

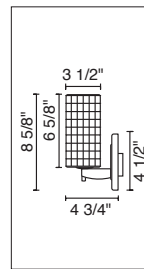

SIERRA SCONCE
102 114bz
102 114ch
102 114mc

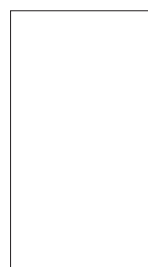
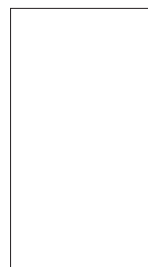
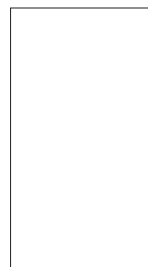
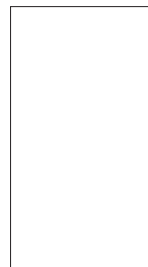
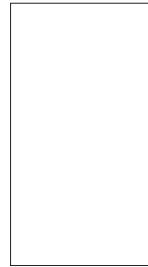
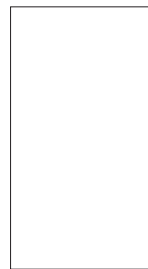
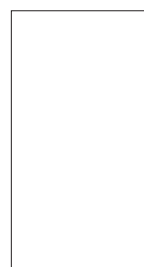
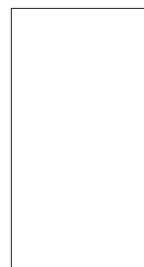
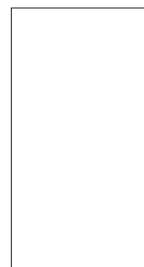
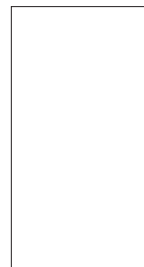
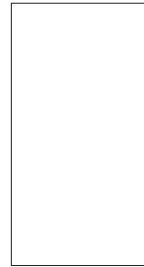

LED SCONCE

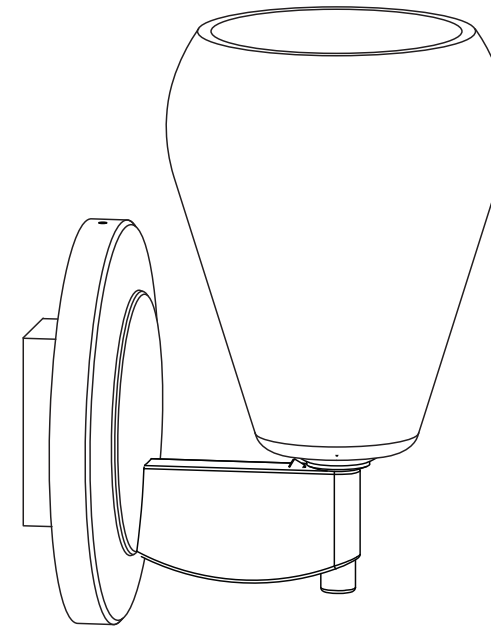

TECHNICAL SPECIFICATIONS

Description: 4" Canopy with J-Box and Glass
Design: Bruck-Team
Lamp: 3 Watt LED

CONTENTS OF DELIVERY

fixture complete



IMPORTANT SAFETY INSTRUCTIONS



1. Save these instructions and refer to them when additions to or changes to the fixture are made.
2. THIS PRODUCT MUST BE INSTALLED BY A PERSON FAMILIAR WITH THE CONSTRUCTION AND OPERATION OF THE PRODUCT AND THE HAZARDS INVOLVED, IN ACCORDANCE WITH THE APPLICABLE NEC CODE.
3. Do not install this fixture in damp or wet locations.
4. CAUTION - Do not install any fixture assembly closer than 6 inches from any curtain, or similar combustible material.
5. Turn off power prior to any work on the systems.
6. Warranty is void in case of unauthorized modifications and/ or improper use.

READ ALL OF THESE INSTRUCTIONS BEFORE INSTALLATION

INSTALLATION INSTRUCTIONS

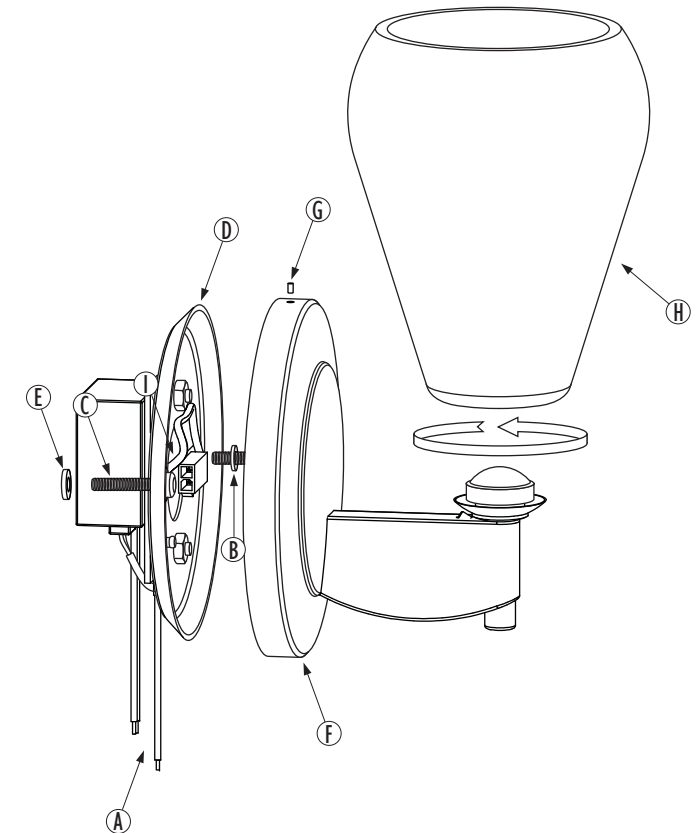

INSTRUCTIONS FOR USE

- Connect the two wires from the transformer (A) to the power cables in the wall. Then slide the notched plastic washer (B) through the mounting screw (C). Insert the screw (C) into the mounting plate (D) and slide the plastic washer (E) onto the end of the screw. Align the screws (C) with the J-box and tighten until firmly connected.

- Connect quick connect (I) then place the canopy cover (F) over the mounting plate (D) and secure it with the allen screw (G) located on the side of the base.

- Remove the glass shade (H) from the fixture by turning the glass counter-clockwise.

NOTE

Zara glass should not be removed.