

SCONCE

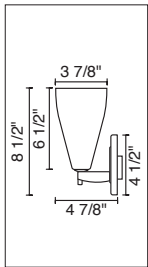

ZARA SCONCE
100 151(bz,ch,mc)
100 152(bz,ch,mc)
100 153(bz,ch,mc)
100 154(bz,ch,mc)
100 156(bz,ch,mc)
100 157(bz,ch,mc)

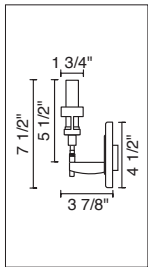

TARGIT SCONCE
100 580ch/mc
100 580mc

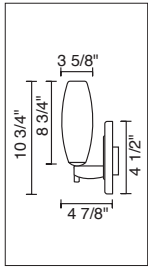

CIRO SCONCE
100 116(bz,ch,mc)
100 119(bz,ch,mc)
100 121(bz,ch,mc)
100 122(bz,ch,mc)
100 123(bz,ch,mc)
100 124(bz,ch,mc)
100 125(bz,ch,mc)

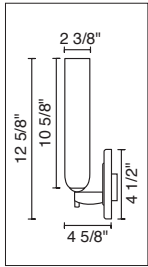

CHIANTI SCONCE
100 820(bz,ch,mc)
100 821(bz,ch,mc)
100 822(bz,ch,mc)
100 823(bz,ch,mc)

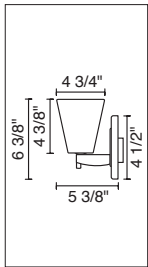

BLING I SCONCE
100 168(bz,ch,mc)
100 173(bz,ch,mc)
100 178(bz,ch,mc)
100 840(bz,ch,mc)
100 841(bz,ch,mc)
100 842(bz,ch,mc)

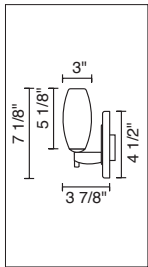

CIRO MINI SCONCE
100 830(bz,ch,mc)
100 831(bz,ch,mc)
100 832(bz,ch,mc)
100 833(bz,ch,mc)

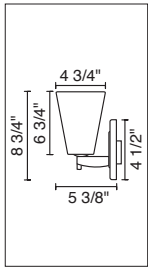

BLING II SCONCE
100 169(bz,ch,mc)
100 174(bz,ch,mc)
100 179(bz,ch,mc)
100 843(bz,ch,mc)
100 844(bz,ch,mc)
100 845(bz,ch,mc)

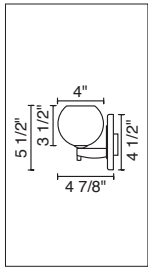

BOBO SCONCE
100 915(bz,ch,mc)
100 917(bz,ch,mc)

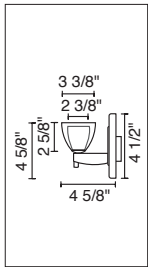

RAINBOW I SCONCE
100 721(bz,ch,mc)
100 722(bz,ch,mc)
100 723(bz,ch,mc)
100 724(bz,ch,mc)
100 913(bz,ch,mc)
100 918(bz,ch,mc)

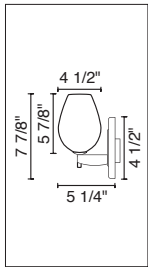

BOLERO SCONCE
100 336(bz,ch,mc)
100 337(bz,ch,mc)
100 338(bz,ch,mc)
100 339(bz,ch,mc)

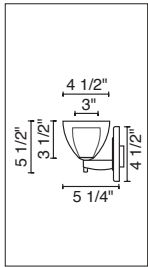

RAINBOW II SCONCE
100 725(bz,ch,mc)
100 726(bz,ch,mc)
100 728(bz,ch,mc)
100 729(bz,ch,mc)
100 816(bz,ch,mc)
100 817(bz,ch,mc)
100 916(bz,ch,mc)
100 919(bz,ch,mc)

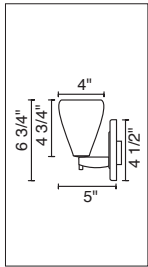

LUCY SCONCE
100 126(bz,ch,mc)
100 127(bz,ch,mc)
100 128(bz,ch,mc)

SCONCE

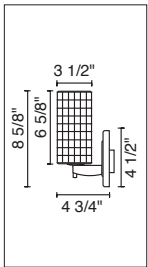

SIERRA SCONCE
100 114bz
100 114ch
100 114mc

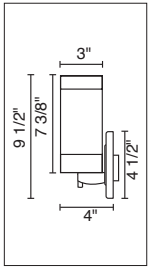

SILVA SCONCE
100 711(bz,ch,mc)
100 712(bz,ch,mc)
100 713(bz,ch,mc)
100 714(bz,ch,mc)
100 715(bz,ch,mc)
100 716(bz,ch,mc)

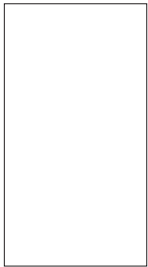
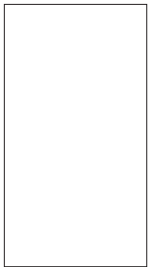
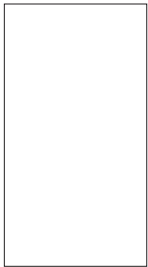
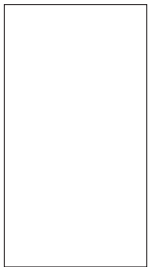

SCONCE

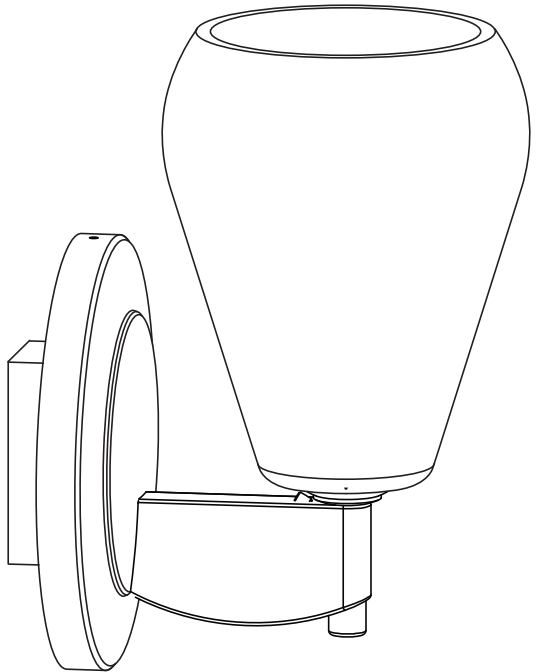

TECHNICAL SPECIFICATIONS

Description: 4" Canopy with J-Box and Glass
Design: Bruck-Team
Lamp: 50 Watt GY6.35

CONTENTS OF DELIVERY

canopy and fixture complete without lamp

IMPORTANT SAFETY INSTRUCTIONS

1. Save these instructions and refer to them when additions to or changes to the fixture are made.
2. THIS PRODUCT MUST BE INSTALLED BY A PERSON FAMILIAR WITH THE CONSTRUCTION AND OPERATION OF THE PRODUCT AND THE HAZARDS INVOLVED, IN ACCORDANCE WITH THE APPLICABLE NEC CODE.
3. Do not install this fixture in damp or wet locations.
4. CAUTION - Do not install any fixture assembly closer than 6 inches from any curtain, or similar combustible material.
5. Turn off power prior to any work on the systems.
6. Warranty is void in case of unauthorized modifications and/ or improper use.

READ ALL OF THESE INSTRUCTIONS BEFORE INSTALLATION

INSTALLATION INSTRUCTIONS

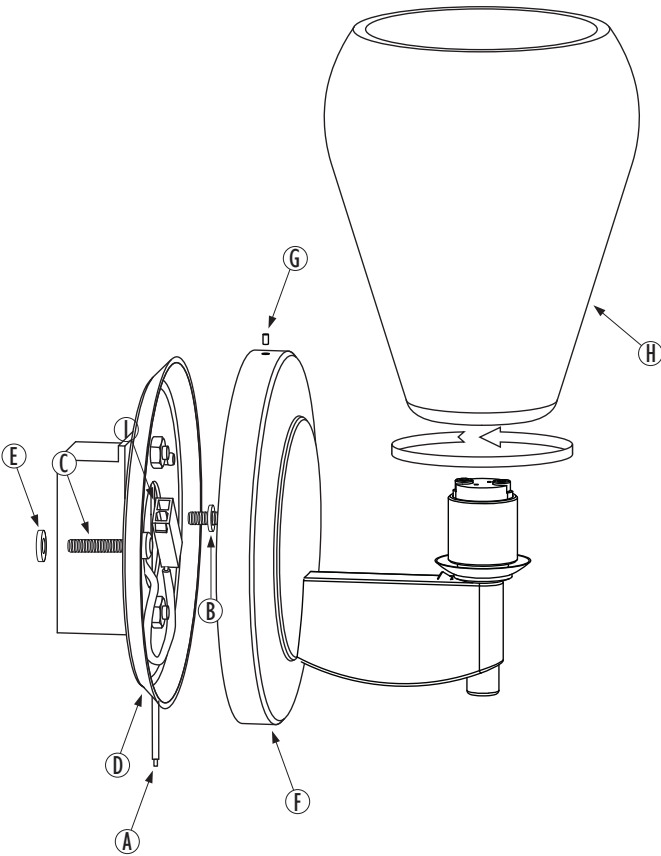

INSTRUCTIONS FOR USE

- The Sconce can be mounted directly to any wall with access to the power cables. Begin by connecting the two wires from the transformer (A) to the power cables in the wall.
- Slide the notched plastic washer (B) through the mounting screw (C). Insert the screw (C) into the mounting plate (D) and slide the plastic washer (E) onto the end of the screw. Align the screws (C) with the J-box and tighten until firmly connected.
- Connect quick connect (I) then place the canopy cover (F) over the mounting plate (D) and secure it with the allen screw (G) located on the side of the base.
- Remove the glass shade (H) from the fixture by turning the glass counter-clockwise. Insert a Bi-Pin lamp into the socket head to complete the installation.

NOTE

Zara glass should not be removed.