

## PENDANTS

### TECHNICAL SPECIFICATIONS

Description: Pendant fixture with coax cable and plug  
Design: Bruck-Team  
Lamp: Low pressure bi-pin: GY6.35, GX5.3, G4

### CONTENTS OF DELIVERY

fixture complete without lamp



### IMPORTANT SAFETY INSTRUCTIONS



1. Save these instructions and refer to them when additions to or changes to the fixture are made.
2. Do not install this fixture in damp or wet locations.
3. CAUTION - Do not install any fixture assembly closer than 6 inches from any curtain, or similar combustible material.
4. Turn off power prior to any work on the systems.
5. Please check that the total lamp wattage does not exceed 50W or wattage specified by fixture.
6. Warranty is void in case of unauthorized modifications and/ or improper use.

### READ ALL OF THESE INSTRUCTIONS BEFORE INSTALLATION

### INSTRUCTIONS FOR USE

- Insert the lamp into the socket as far as it will go. Make sure the pin spacing and wattage are correct for your fixture.

- Mount the fixture to the canopy or adaptor by plugging in the Uni-Plug. The Uni-Plug will 'click' when properly inserted. Turn the retaining collar to complete the installation (see diagram).

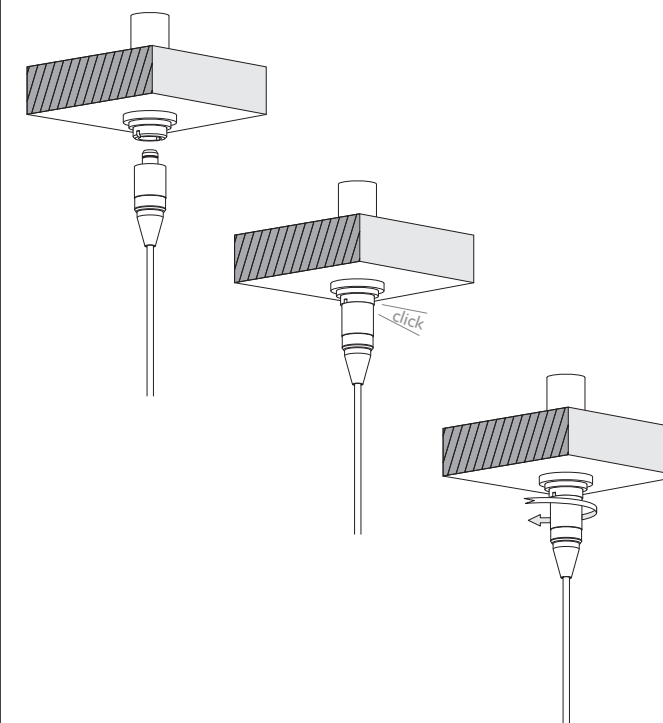

## INSTALLATION INSTRUCTIONS

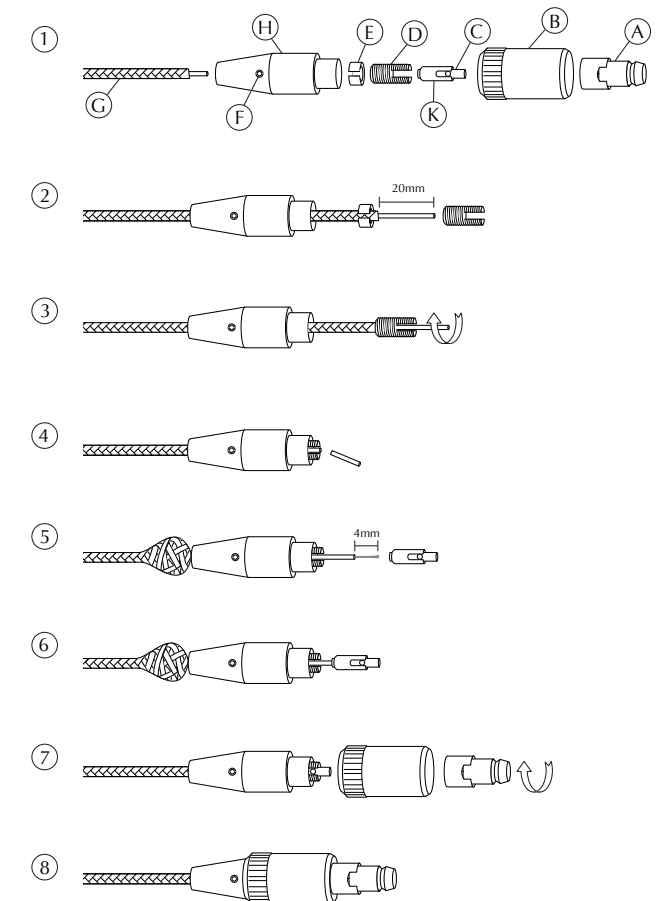

### INSTRUCTIONS FOR USE

1. Disassemble the uni-plug by:
  - removing plug A with the hexagonal key.
  - removing the knurled screw B.
  - loosening screw C.
  - unscrew part D with the hexagonal screw.
  - loosening screw F.
  - pushing the cable G through the plug reception H.
  - removing the clamp conus E.
2. Shorten the cable G to the desired length. Push the clamp conus E on. Push the stranded exterior of the cable G so that the interior cable is exposed.
3. Place the cable G with clamp conus E into the plug reception H. Screw in the interior part D.
4. Cut the excess interior cable so that it is flush with part D.
5. Push the stranded cable G through the plug reception to re-expose the interior cable. Strip away 4mm of insulation away from the interior cable.
6. Attach screw plug with plastic sleeve K; fasten screw C firmly.
7. Pull the exterior cable G back. Push the screw plug with plastic sleeve K into the interior part D. Place the knurled nut on to the plug reception. Screw the plug A on and fasten it firmly.
8. Fasten the screw F.

PENDANTS

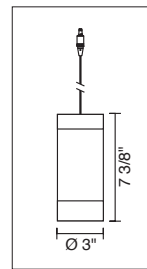

**SILVA DOWN**  
220 711(bz,ch,mc)  
220 712(bz,ch,mc)  
220 713(bz,ch,mc)  
220 714(bz,ch,mc)  
220 715(bz,ch,mc)  
220 716(bz,ch,mc)

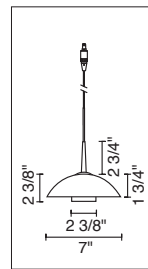

**JAS DOWN**  
222 910(bz,mc)/am  
222 910(bz,mc)/bl  
222 910(bz,mc)/wh

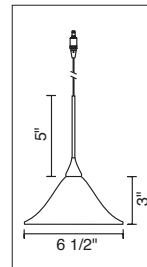

**BELLA DOWN**  
220 091(bz,ch,mc)  
220 092(bz,ch,mc)  
220 094(bz,ch,mc)  
220 096(bz,ch,mc)  
220 099(bz,ch,mc)

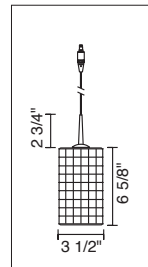

**SIERRA DOWN**  
220 114bz  
220 114ch  
220 114mc

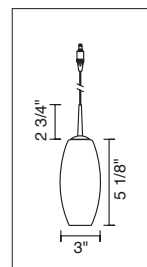

**CIRO MINI DOWN**  
220 830(bz,ch,mc)  
220 831(bz,ch,mc)  
220 832(bz,ch,mc)  
220 833(bz,ch,mc)

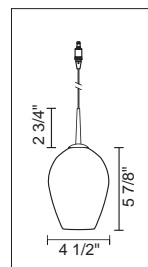

**BOLERO DOWN**  
220 336(bz,ch,mc)  
220 337(bz,ch,mc)  
220 338(bz,ch,mc)  
220 339(bz,ch,mc)

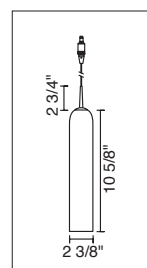

**CHIANTI DOWN**  
220 820(bz,ch,mc)  
220 821(bz,ch,mc)  
220 822(bz,ch,mc)  
220 823(bz,ch,mc)

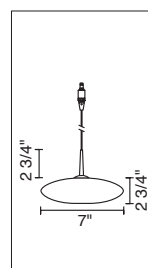

**MYSTIQUE DOWN**  
220 190(bz,ch,mc)  
220 191(bz,ch,mc)

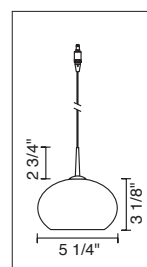

**LAGUNA DOWN**  
220 810(bz,ch,mc)  
220 811(bz,ch,mc)  
220 812(bz,ch,mc)  
220 813(bz,ch,mc)  
220 814(bz,ch,mc)  
220 815(bz,ch,mc)

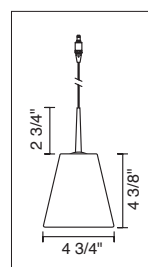

**BLING I DOWN**  
220 168(bz,ch,mc)  
220 173(bz,ch,mc)  
220 178(bz,ch,mc)  
221 840(bz,ch,mc)  
221 841(bz,ch,mc)  
221 842(bz,ch,mc)

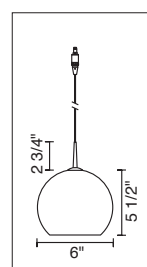

**ZON DOWN**  
220 801bz  
220 801ch  
220 801mc

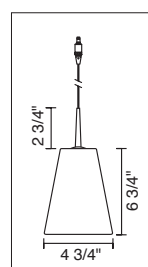

**BLING II DOWN**  
220 169(bz,ch,mc)  
220 174(bz,ch,mc)  
220 179(bz,ch,mc)  
221 843(bz,ch,mc)  
221 844(bz,ch,mc)  
221 845(bz,ch,mc)

PENDANTS

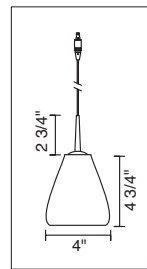

**LUCY DOWN**  
220 126(bz,ch,mc)  
220 127(bz,ch,mc)  
220 128(bz,ch,mc)

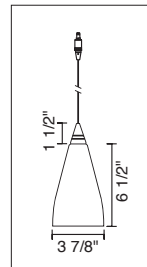

**ZARA DOWN**  
220 151(bz,ch,mc)  
220 152(bz,ch,mc)  
220 154(bz,ch,mc)  
220 156(bz,ch,mc)  
220 157(bz,ch,mc)

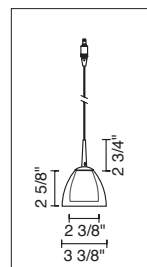

**RAINBOW I DOWN**  
220 721(bz,ch,mc)  
220 722(bz,ch,mc)  
220 723(bz,ch,mc)  
220 724(bz,ch,mc)  
220 913(bz,ch,mc)  
220 918(bz,ch,mc)

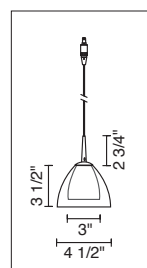

**RAINBOW II DOWN**  
220 725(bz,ch,mc)  
220 726(bz,ch,mc)  
220 728(bz,ch,mc)  
220 729(bz,ch,mc)  
220 816(bz,ch,mc)  
220 817(bz,ch,mc)  
220 916(bz,ch,mc)  
220 919(bz,ch,mc)

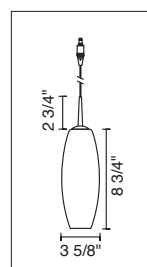

**CIRO DOWN**  
220 116(bz,ch,mc)  
220 119(bz,ch,mc)  
220 121(bz,ch,mc)  
220 122(bz,ch,mc)  
220 123(bz,ch,mc)  
220 124(bz,ch,mc)  
220 125(bz,ch,mc)

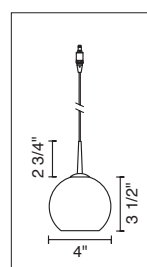

**BOBO DOWN**  
220 915(bz,ch,mc)  
220 917(bz,ch,mc)

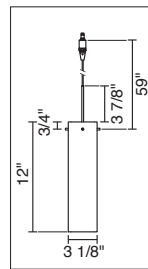

**HOUSTON DOWN**  
221 850(bz,ch,mc)  
221 851(bz,ch,mc)  
221 852(bz,ch,mc)  
221 853(bz,ch,mc)

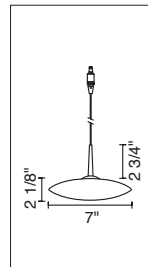

**POISE DOWN**  
220 297bz  
220 297ch  
220 297mc

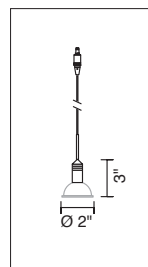

**PIA II DOWN**  
220 144ch  
220 144mc

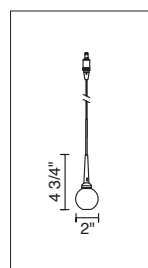

**BAMBOLINO DOWN**  
220 910mc/am  
220 910mc/bl  
220 910mc/rd  
220 910mc/wh

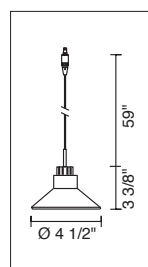

**KIM DOWN**  
220 640(bz,ch,mc)  
220 641(bz,ch,mc)

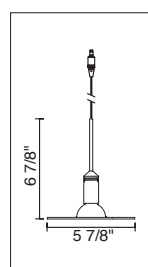

**PIA I DOWN**  
220 097(bz,ch,mc)  
220 140ch  
220 141(bz,mc)  
220 142ch  
220 143(bz,mc)  
220 146(bz,ch,mc)  
220 147(bz,ch,mc)  
220 148(bz,ch,mc)  
220 149(bz,ch,mc)

PENDANTS

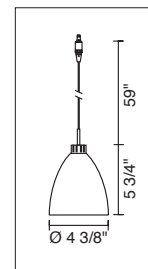

**TARA DOWN**  
220 941bz  
220 941ch  
220 941mc

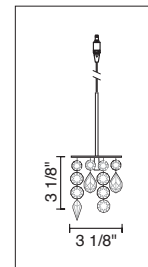

**CRISTELLO DOWN**  
220 209(ch,mc)  
220 235(bz,ch,mc)  
220 236(ch,mc)

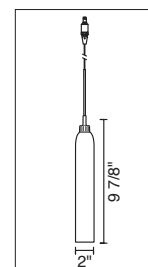

**CANDLE DOWN**  
220 642bz  
220 642ch  
220 642mc

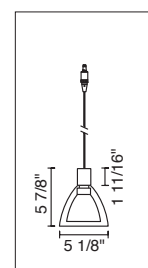

**CANTO DOWN**  
220 945ch  
220 945mc

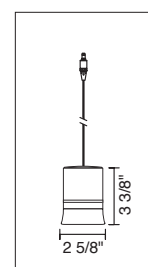

**APOLLOS DOWN I**  
220 445mc

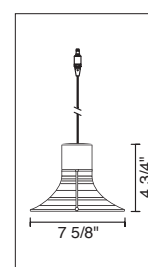

**APOLLOS DOWN II**  
220 447mc

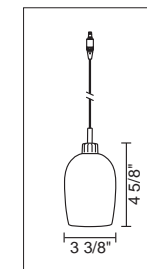

**QUEENY I DOWN**  
220 321(bz,ch,mc)  
220 322(bz,ch,mc)  
220 323(bz,ch,mc)  
220 324(bz,ch,mc)  
220 325(bz,ch,mc)  
220 370(bz,ch,mc)  
220 371(bz,ch,mc)  
220 372(bz,ch,mc)  
220 373(bz,ch,mc)

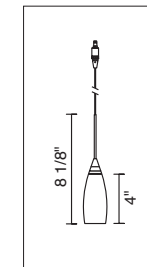

**KANE DOWN**  
220 050mc

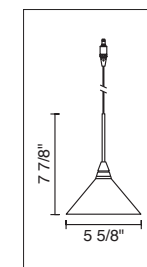

**NIKAI DOWN**  
220 060mc

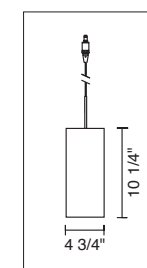

**CANTARA I DOWN**  
220 008(bz,ch,mc)  
220 009(bz,ch,mc)

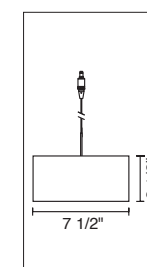

**CANTARA II DOWN**  
220 001(bz,ch,mc)  
220 002(bz,ch,mc)

PENDANTS

