

# **Blomberg**

## **Electric Range**

### User Manual

#### **IMPORTANT**

**Installer** should leave these instructions with appliance.

**Consumer** should read these instructions before using the appliance and should retain them for future reference.

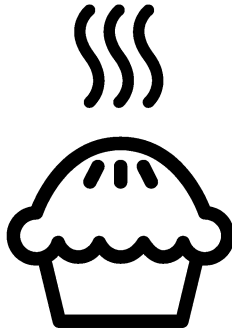

BIR34452SS

**EN**

285.6002.28/R.AC/25.01.2021/3-1

7732187990

# **IMPORTANT SAFETY INSTRUCTIONS**

## **READ AND SAVE THESE INSTRUCTIONS**



**WARNING:** Read all safety instructions before using the product. If the information in this manual is not followed exactly, a fire or explosion may result causing property damage, personal injury or death.

**TO PREVENT TIPPING:** If the information in this manual is not followed exactly, a fire or explosion may result causing property damage, personal injury or death.



## WARNING:

"A child or adult can tip the range and be killed.

Install the anti-tip device packed with range to the structure floor."

"Engage the range to the anti-tip device by sliding range so that rear foot of the range slides in to the bracket as shown in figures."

"Re-engage the anti-tip device if the range is moved. "

See installation instructions.

"Failure to follow these instructions can result in death or serious burns to children or adults."

Do not operate the range without anti-tip device in place and engaged.



## WARNING:

- **DO NOT OPERATE THE RANGE WITHOUT ANTI-TIP DEVICE IN PLACE AND ENGAGED**

"After installation cautiously grip the rear of the range to ensure the anti-tip bracket is engaging the rear foot of range."

Check for proper installation and use of the anti-tip bracket. Carefully tip the range forward pulling from the back to ensure that the anti-tip bracket engages the range leg and prevents tip-over. Range should not move more than 1" (25 mm).



## IMPORTANT:

This appliance is intended for normal household use only. It is not approved for outdoor or other non-household uses (including sea or air-going vessels). See the Statement of Limited Warranty. If you have any questions, contact the manufacturer.

Do not repair or replace any part of the appliance unless specifically recommended in this manual. Refer all servicing to a factory authorized service center.

## Explanation of symbols

Throughout this User Manual the following symbols are used:

 Important information or useful hints about usage.

 Warning for hazardous situations with regard to life and property.

 Warning for electric shock.

 Warning for risk of fire.

 Warning for hot surfaces.

**DANGER** indicates a hazardous situation which, if not avoided, will result in death or serious injury.

**WARNING** indicates a hazardous situation which, if not avoided, could result in death or serious injury.

**CAUTION** indicates a hazardous situation which, if not avoided, could result in minor or moderate injury.

**NOTICE** is used to address practices not related to physical injury.

 **Please read these instructions before installation  
or using your appliance!**

**Dear Customer,**

We would like you to obtain best performance with your product that has been manufactured in modern facilities and passed through strict quality control procedures.

Therefore, we advise you to read through this user manual carefully before using your product and keep it for future reference. If you hand over the product to someone else, deliver the user manual as well.

The user manual will help you use the product in a fast and safe way.



**IMPORTANT:**

**Save these instructions for the local electrical inspectors use.**



**IMPORTANT:**

**This product can only be used in the rooms which incorporates a properly adjusted and functioning Carbon Monoxide sensor. Make sure the Carbon Monoxide sensor works properly and its maintenance done frequently. Carbon Monoxide sensor should be installed maximum 6.5 feet away from the product.**

**The instructions will help you to operate the appliance quickly and safely.**

- Upon delivery, please check that the appliance is not damaged. If you note any transport damage, please contact your point of sale immediately and do not connect and operate the appliance!
- Before you connect and start using the appliance, please read this manual and all enclosed documents. Please note in particular the safety instructions.
- Keep all documents so that you can refer to the information again later on.  
Please keep your receipt for any repairs which may be required under warranty.
- When you pass on the appliance to another person, please provide all documents including original date of purchasing. Warranty is not valid if the product is sold second hand.
- If you should decide not to use this appliance any longer (or decide to substitute an older model), before disposing of it, it is recommended that it be made inoperative in an appropriate manner in accordance to health and environmental protection regulations, ensuring in particular that all potentially hazardous parts be made harmless, especially in relation to children who could play with old appliances. Remove the door before disposal to prevent entrapment.

## TABLE OF CONTENTS

### **1 Safety Instructions - Read before use**

**7**

Basic safety instructions .....	7
Safety for children .....	13
Safety when working with electricity .....	14
Intended use.....	14
Disposal .....	15
Packaging material.....	15
Future transportation.....	15

### **2 Installation**

**16**

Installation and connection.....	16
Connection to the main supply .....	22

### **3 Preparation**

**26**

Tips for saving energy .....	26
First cleaning of the appliance.....	26
Initial heating .....	26

### **4 How to use the hob**

**28**

General information about cooking .....	28
Using the burners/plates.....	31
Using the hobs.....	31
Turning on the cooking zones .....	31

### **5 How to operate the oven**

**35**

General information on baking, roasting and broiling .....	35
How to use the electric oven .....	36
Cooking times table.....	38
How to operate the broil.....	39

### **6 Maintenance and care**

**40**

General information .....	40
Cleaning the burner/plate .....	40
Cleaning the control panel .....	40
Cleaning the oven .....	40
Removing the oven door .....	42
Replacing the oven lamp.....	42

### **7 General information**

**44**

Overview.....	44
Technical specifications.....	45
Package contents.....	46

### **8 Troubleshooting**

**47**

### **9 Removing the Package**





**48**









### **10 WARRANTY STATEMENT FOR BLOMBERG ELECTRIC AND GAS RANGES**

**50**

## **1 Safety Instructions - Read before use**

### **Basic safety instructions**

- This appliance is not intended for use by persons (including children) with reduced physical, sensory or mental capabilities, or lack of experience and knowledge, unless they have been given supervision or instruction concerning use of appliance by a person responsible for their safety.
- Children should be supervised to ensure that they do not play with the appliance.
- Be sure your range is installed and grounded properly by a qualified installer or service technician.
- If the supply cord damaged, it must be replaced by a special cord or assembly available from the manufacturer or its service agent or similarly qualified persons.
- ** WARNING:** Never use your appliance for warming or heating the room.
- Do not repair or replace any part of the appliance unless specifically recommended in the manual. All other servicing should be referred to a qualified technician.
- ** CAUTION:** Use proper pan size - this appliance is equipped with one or more surface units of different size. Select utensils having flat bottoms large enough to cover the surface unit heating element. The use of undersized utensils will expose a portion of the heating element to direct contact and may result in ignition of clothing. Proper relationship of utensil to heating element will also improve efficiency.
- ** WARNING:** Never leave surface units unattended at high heat settings. Boil over causes smoking and greasy spill overs that may ignite.
- ** CAUTION:** Do not use aluminum foil to line drip pans or anywhere in the oven, except as described in this manual. Foil can trap heat or melt, resulting in damage to the product and a shock or fire hazard.
- ** WARNING:** Glazed cooking utensils - only certain types of glass, glass/ceramic, ceramic, earthenware, or other glazed utensils are suitable for range-top service without breaking due to the sudden change in temperature.

-  **WARNING:** Utensil handles should be turned inward and not extend over adjacent surface units - to reduce the risk of burns, ignition of flammable materials, and spillage due to unintentional contact with the utensil, the handle of a utensil should be positioned so that it is turned inward, and does not extend over adjacent surface units.
- The appliance is not intended to be operated by means of an external timer or separate remote-control system.
-  **WARNING:** Accessible parts may become hot during use. Young children should be kept away.
-  **CAUTION:** Do not use harsh abrasive cleaners or sharp metal scrapers to clean the oven door glass since they can scratch the surface, which may result in shattering of the glass.
-  **WARNING:** This appliance can be used by children aged from 8 years and above and persons with reduced physical, sensory or mental capabilities or lack of experience and knowledge if they have been given supervision or instruction concerning use of the appliance in a safe way and understand the hazards involved.
- Children shall not play with the appliance. Cleaning and user maintenance shall not be made by children without supervision.
-  **WARNING:** The appliance and its accessible parts become hot during use. Care should be taken to avoid touching heating elements. Children less than 8 years of age shall be kept away unless continuously supervised.
-  **WARNING:** Appliance must be placed directly on the floor. It must not be placed onto a base or a pedestal.
-  **WARNING:** Rear surface of the oven gets hot when it is in use. Make sure that the electrical connection does not contact the rear surface; otherwise, connections can get damaged.
-  **WARNING:** Only use the connection cable specified in the “Technical specifications”. If the supply cord damaged, it must be replaced by a special cord or assembly available from the manufacturer or its service agent or similarly qualified persons in order to avoid a hazard.
-  **WARNING:** During self-cleaning, surfaces may become





hotter than with standard use.  
Keep children away.



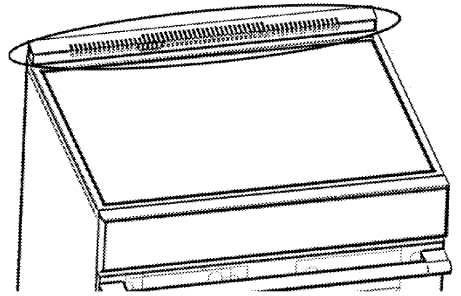





- **⚠ WARNING:** Metallic objects such as knives, forks, spoons and lids should not be placed on the hob surface since they can get hot.
- **⚠ CAUTION:** Only use the temperature probe recommended for this oven.
- **⚠ CAUTION:** Use care when opening door- let hot air or steam escape before removing or replacing food.
- **⚠ CAUTION:** Placement of oven racks -always place oven racks in desired location while oven is cool. If rack must be moved while oven is hot, do not let potholder contact hot heating element in oven.
- **⚠ CAUTION:** Use only dry potholders- moist or damp potholders on hot surfaces may result in burns from steam. Do not let potholder touch hot heating elements.  
Do not use a towel or other bulky clothes.
- Your body accidentally can turn the knobs, please make sure that your body do not touch to knobs not for use.
- **⚠ WARNING:** Never cover the top of grates with any kind of







cover. Use only cooking utensils with recommended diameters. Make sure ventilation and oven fume outlets shown below are not closed. Otherwise fire hazard can occur.



- Do not heat closed food containers and glass jars. Pressure that may build-up in the jar can cause it to burst.
- **⚠ WARNING:** Food Poisoning Hazard: Do not let food sit in oven for more than 1 hour before or after cooking. Doing so can result in food poisoning or sickness.
- **⚠ WARNING:** To avoid permanent damage to the oven bottom finish do not line the oven bottom with any type of foil or liner.
- **⚠ WARNING:** Do not cook on broken cook-top - if cook-top should break, cleaning solutions and spillovers may penetrate the broken cook-top and create a risk of electric shock. Contact a qualified technician immediately.

-  **CAUTION:** If a wet sponge or cloth is used to wipe spills on a hot cooking area, be careful to avoid steam burn. Some cleaners can produce noxious fumes if applied to a hot surface. Utensil handles should be turned inward and not extend over adjacent surface units. To reduce the risk of burns, ignition of flammable materials, and spillage due to unintentional contact with the utensil, the handle of a utensil should be positioned so that it is turned inward, and does not extend over adjacent surface units.
- Ensure that no flammable materials are adjacent to the appliance as the sides become hot during use.
-  **CAUTION:** Do not store or use flammable materials in an oven or near the cook top, including paper, plastic, pot holders, linens, wall coverings, curtains, drapes and gasoline or other flammable vapors and liquids.
-  **WARNING: "Do not touch heating elements or interior surfaces of oven** - Heating elements may be hot even though they are dark in color. Interior surfaces of an oven become hot enough to cause burns. During and after use, do not touch, or let clothing or other flammable materials contact heating elements or interior surfaces of oven until they have had sufficient time to cool. Other surfaces of the appliance may become hot enough to cause burns - among these surfaces are oven vent openings and surfaces near these openings, interior surfaces of the oven cavity, oven doors, and window."
- Never use when judgment or coordination is impaired by the use of alcohol and/or drugs.
- Do not operate the appliance if it is defective or shows any visible damage.
- Do not carry out any repairs or modifications on the appliance. However, you may remedy some malfunctions; see Troubleshooting.
- Be careful when using alcoholic drinks in your dishes. Alcohol evaporates in high temperatures and may cause fire since it will catch fire when it gets in contact with hot surfaces.
- Do not heat unopened food containers. Pressure could build up and the container could burst, causing an injury.

- Do not use the oven for a storage area. Items stored in an oven can ignite.
-  **WARNING:** Storage in or on Appliance- Flammable materials should not be stored in an oven or near surface units.
-  **WARNING:** Keep appliance area clear and free from combustible materials, gasoline, and other flammable vapors.
-  **WARNING:** Do not use water on grease fires. Never pick up a flaming pan. Turn the controls off. Smother a flaming pan on a surface unit by covering the pan completely with a well-fitting lid or a fire blanket, cookie sheet or flat tray. Use a multi-purpose dry chemical or foam-type fire extinguisher. If there is a fire in the oven during baking, smother the fire by closing the oven door and turning the oven off or by using a multi-purpose dry chemical or foam-type fire extinguisher.
-  **WARNING:** Keep the oven free from grease buildup. Grease in the oven may ignite.
-  **WARNING:** Do not use the oven to dry newspapers. If overheated, they can catch on fire.
-  **WARNING:** Do not leave paper products, cooking utensils or food in the oven when not in use.
- Do not leave empty pots or pans on plates that are switched on. They might get damaged.
- Since it may be hot, do not leave plastic or aluminum dishes on the surface of appliance. These kind of dishes should not be used to keep food either.
- Do not place baking trays, dishes or aluminum foil directly onto the bottom of the oven. The heat accumulation might damage the bottom of the oven.
-  **WARNING:** After broiling, always take any broiler pan out of the oven and clean it. Leftover grease in a broiler pan can catch fire next time you use the pan.
- Check that all controls on the appliance are switched off after use.
-  **WARNING:** Keep all ventilation slots clear of obstructions.
- Only authorized replacement parts may be used in performing service on the range. Replacement parts are available from factory authorized parts distributors. Contact the nearest parts distributor in your area.

- Rear surface of the oven gets hot when it is in use. Electric connection should not touch the rear surface, otherwise the main cable may get damaged. Do not trap the main cable between the hot oven door and frame. Do not route the main cable over the hot cooking section. Otherwise, cable insulation may melt and cause fire as a result of short circuit.
-  **WARNING:** Use this appliance for its intended purpose as described in this owner's manual.
- The manufacturer declines all liability for injury to persons or damage to property caused by incorrect or improper use of the appliance.
-  **CAUTION:** Always use heat-resistant gloves when putting or removing the dishes into/from your oven.
-  **CAUTION:** Always use Only Dry Potholders or heat-resistant gloves when putting or removing the dishes into/from your oven. Do not let potholder touch hot heating elements.
-  **WARNING:** Never cover any slots, holes or passages in the oven bottom or cover an entire rack with materials such as aluminum foil. Doing so blocks airflow through the oven and may cause carbon monoxide poisoning. Aluminum foil linings may also trap heat, causing a fire hazard.
- Do not use the oven with front door glass removed or broken.
-  **WARNING:** Heating element may be hot even though they are dark in color. Interior surfaces of an oven become hot enough to cause burns. During and after use, do not touch or let clothing or other flammable materials contact heating elements or interior surfaces of oven until they have had sufficient time to cool. Other surfaces of the appliance may become hot enough to cause burns- among these surfaces are (identification of surfaces – for example, oven vent openings and surfaces near these openings, oven door, and windows of oven doors).
-  **WARNING:** Avoid scratching or impacting glass doors, cook tops or control panels. Doing so may lead to glass breakage. Do not cook on a product with broken glass. Shock, fire or cuts may occur.
-  **WARNING:** Rear surface of the oven gets hot when it is in

use. Electric connection should not touch the rear surface, otherwise the mains cable may get damaged. Do not trap the mains cable between the hot oven door and frame. Do not route the mains cable over the hot cooking section. Otherwise, cable insulation may melt and cause fire as a result of short circuit.

- If the surface is cracked, switch off the appliance to avoid the possibility of electric shock.
- Vapour pressure that build up due to the moisture on the hob surface or at the bottom of the pot can cause the pot to move. Therefore, make sure that the oven surface and bottom of the pots are always dry.
- After use, switch off the hob element by its control and do not rely on the pan detector.
- Metallic objects such as knives, forks, spoons and lids should not be placed on the hob surface since they can get hot.
- Hotplates are equipped with "Induction" technology. Your induction hob that provides both time and money savings must be used with pots suitable for induction cooking; otherwise hotplates will not operate. See.

*General information about cooking, selecting the pots.*

- As induction hobs create a magnetic field, they may cause harmful impacts for people who use devices such as insulin pump or pacemaker.
- Check all controls on the appliance are switched off after use.
- ** IMPORTANT:** Call the authorized service for installation of the appliance to be used. After this procedure, guarantee period will be started.



### **Safety for children**

- **WARNING:** Stepping, leaning or sitting on the door or drawers of this range can result in serious injuries and also cause damage to the range. Do not allow children to climb or play around the range. The weight of a child on an open door may cause the range to tip, resulting in serious burns or other injury.
- Accessible parts may be hot when the broil is in use. Young children should be kept away.
- Surface units may be hot even though they are dark in color. Areas near surface units may become hot enough to cause burns. During and after use, do not touch or let clothing or other flammable materials contact

surface units until they have had sufficient time to cool. Among these areas are (identification of areas) for example, the cook-top and surfaces facing the cook-top.

-  **WARNING:** Do not store items of interest to children in the cabinets above the range or on back guard of a range. Children climbing on the range to reach items could be seriously injured.
- The packaging materials will be dangerous for children. Keep the packaging materials away from children. Please dispose of all parts of the packaging according to environmental standards.

### **Safety when working with electricity**

-  **WARNING:** Before installing, turn power OFF at the service panel. Lock service panel to prevent power from being turned ON accidentally.
-  **WARNING:** Personal injury or death from electrical shock may occur if the range is not installed by a qualified installer or electrician.
- Any additions, changes or conversions required in order for this appliance to satisfactorily meet the application needs must be made by a qualified technician.

- Before performing any service, unplug the range or disconnect the power supply at the household distribution panel by removing the fuse or switching off the circuit breaker.
- Ensure that the fuse rating is correct.
- Do not operate the appliance barefooted.
- Never touch the appliance with wet hands or feet.

### **Intended use**

-  **WARNING:** Use this appliance only for its intended use as described in this manual. NEVER use this appliance as a space heater to heat or warm a room. Doing so may result in carbon monoxide poisoning and overheating the appliance. Never use the appliance for storage.
- This appliance should not be used for warming the plates under the broil, hanging towels and dish cloths on the handles, for drying and the space heating purposes.
- All openings in the wall behind the appliance and in the floor under the appliance shall be sealed.
- This appliance is not intended to use at mobile homes, recreational vehicles.

-  **WARNING:** Do not obstruct the flow of ventilation air.
- The manufacturer shall not be held liable for any damage caused by improper use or handling errors.
- The appliance can be used for defrosting, baking, roasting and broiling food.

## Disposal

### Packaging material



**DANGER:**  
Risk of suffocation by the packaging materials!  
Packing elements (i.e. plastic bags, polystyrene foam, nails, packing straps, etc.) should not be left around within easy reach of children, as these may cause serious injuries.

The packaging material and transport locks are made from materials that are not harmful to the environment. Please dispose of all parts of the packaging according to environmental standards. This is beneficial to the environment.



**CAUTION:**  
If product will be given to someone for personal use or given to someone for second hand use, User manual, product labels, other related documents, mounting parts etc. should be given with product.

## Future transportation

Do not carry out cleaning or maintenance operations on the appliance without having previously disconnected it from the electric power supply.



**NOTICE:**  
Do not place other items on the top of the appliance. The appliance must be transported upright.

Store the appliance's original box and transport the appliance in its original carton. Follow the guidance marks that are printed on the carton.



**IMPORTANT:**  
Verify the general appearance of your equipment by identifying possible damage during the transportation.

To prevent the wire shelf and tray inside the oven from damaging the oven door, place a strip of cardboard onto the inside of the oven door that lines up with the position of the trays. Tape the oven door to the side walls.

### If you do not have the original carton

Pack the appliance in bubble wrap or thick cardboard and tape it securely in order to prevent damage during transportation.

## 2 Installation

The kitchen floor must be able to carry the weight of the appliance plus the additional weight of cookware and bake ware and food.

- If an appliance hood is to be fitted, refer to the manufacturer's instructions regarding fixing height.
- Any kitchen furniture next to the appliance must be heat-resistant (212°F/100°C min.).

### Installation and connection



#### IMPORTANT:

Do not install the appliance next to refrigerators or freezers. The heat emitted by the appliance will lead to an increased energy consumption of cooling appliances.

- For installation the appliance must be connected in accordance with all local electrical regulations.



#### CAUTION:

Unit is heavy (approximately 150 kg (330 lbs) and requires at least two persons or proper equipment to move. Do not move more than 3 meters without any instrument. Otherwise, you can cause injury..



#### NOTICE

**Material damage!**

The door and/or handle must not be used for lifting or moving the appliance. The appliance must be placed directly on the floor. It must not be placed onto a base or a pedestal.

- To align the appliance with the worktop, adjust the feet turning right or left hand as required.
- Hidden surfaces may have sharp edges. Use caution when reaching behind or under appliance.
- Do not use the oven or warming drawer (if equipped) for storage.



#### NOTICE

**Material damage!**

Do not place other items on the top of the appliance. The appliance must be transported upright. The door and/or handle must not be used for lifting or moving the appliance. Take care not to touch the oven heating element also located at the top of the oven cavity, just behind the ridged area. It is recommended to wear gloves and long sleeves to protect hands and forearms from abrasion and potential scratches during the lifting process. It is also recommended to take off watches and jewelry and to wear work shoes during installation for foot protection. Remove the oven door for easier handling and installation.

- The appliance must be placed directly on the floor. It must not be placed onto a base or a pedestal.



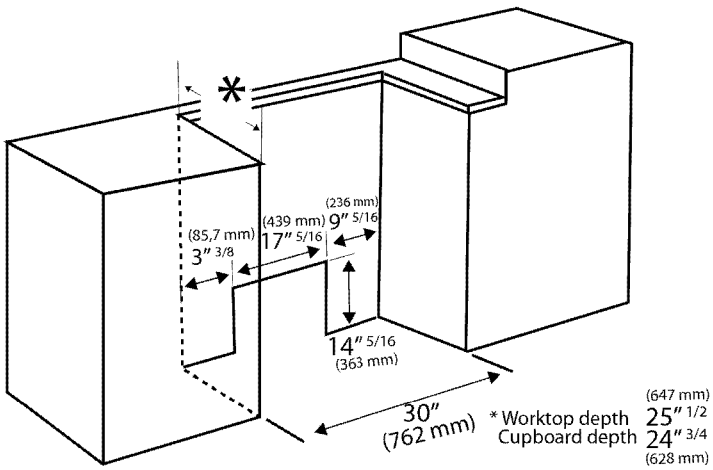
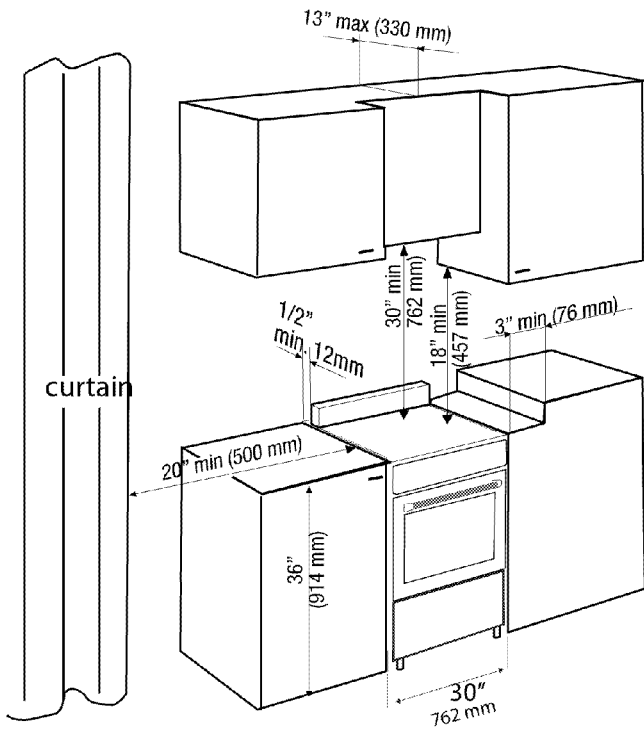

## Clearances & Dimensions

Dimensions that are shown in figure must be used. Given dimensions provide minimum clearance. There needs to be a 30-inch (762mm) minimum clearance between the top of the cooking surface and the bottom of unprotected wood or metal cabinets or a 24-inch (609mm) minimum when bottom of wood or metal cabinets are protected by not less than a 1/4-inch (6mm) flame retardant millboard covered with not less than no. 29 msg sheet-steel, 0.015-inch (38mm) stainless steel, 0.024-inch (0.6mm) aluminum or 0.020-inch (0.05mm) copper.

To eliminate the risk of burns or fire by reaching over heated surface units, cabinet storage space located above the surface units should be avoided. If cabinet storage is to be provided, the risk can be reduced by installing a range hood that projects horizontally a minimum of 5 inches (127mm) beyond the bottom of the cabinets.



### Important notes to the consumer

Keep this manual for future reference.

- As when using any range generating heat, there are certain safety precautions you should follow. These are listed in the front of this manual. Read and follow carefully.
- Be sure your range is installed and grounded properly by a qualified installer or service technician.
- To eliminate the need to reach over the cook top, cabinet storage space above the cook top should be avoided.



### Important notes to the installer

Read manual before installing the range.

Observe all governing codes and ordinances.

Be sure to leave these instructions with the consumer.

Be sure your range is installed and grounded properly by a qualified installer or service technician.



### IMPORTANT:

Before installing the range in an area covered with linoleum or any other synthetic floor covering, make sure the floor covering can withstand heat at least 90°F (32.2°C) above room temperature without shrinking, warping or discoloring.

Do not install the range over carpeting unless you place an insulating pad or sheet of 1/4 inch (0.64cm) thick plywood between the unit and carpeting.



### WARNING:

All ranges can tip and injury to persons could result.

- A child or adult can tip the range and be killed.
- Anti-Tip stability devices are fixed on wooden plate. During the removing packaging materials, the Anti-Tip stability devices should be unscrewed from wooden plate and should not be thrown away.
- A risk of tip-over may exist if the appliance is not installed in accordance with these instructions.
- If the range is pulled away from the wall for cleaning, service or any other reason, ensure that the Anti-Tip Device is properly re-engaged when the range is pushed back against the wall. In the event of abnormal usage (such as a person standing, sitting or leaning on an open door), failure to take this precaution can result in tipping of the range. Personal injury might result from spilled hot liquids or from the range itself.

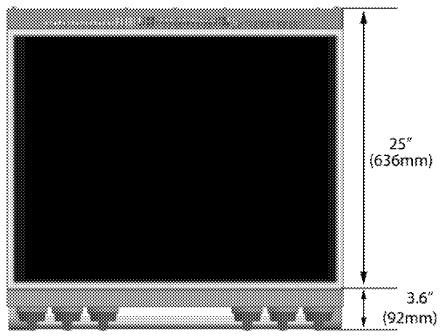
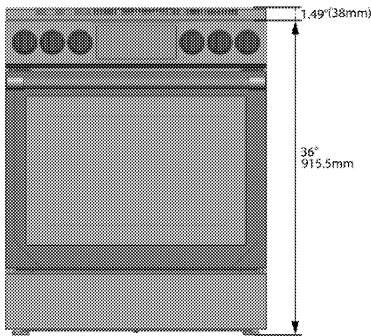
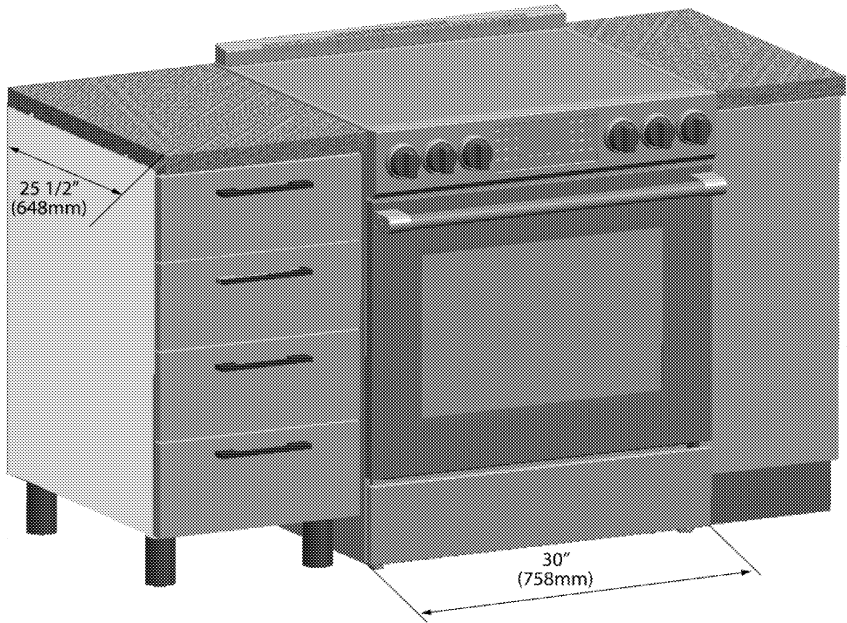

## Anti-Tip stability device installation instructions

1. Fix the bracket 1 to the floor with 4 screws (5) in accordance with the dimensions and direction indicated in Picture 1.
2. Measure dimension A of the product indicated in Picture 2 according to the height of counter. Decide the hole on bracket 1 to which the

- bracket 2 will be secured. Complete the installation by tightening parts 3 and 4.
3. Position the appliance on its place after completing the installation.
4. Check whether the appliance is locked with bracket by gently lifting it up from rear side of front side.

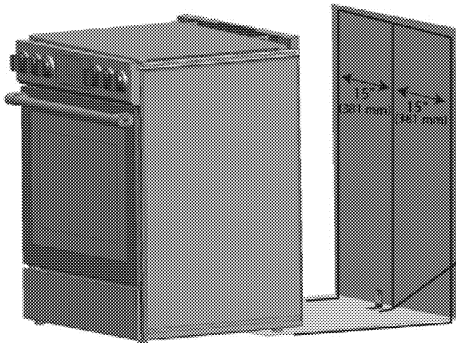

PICTURE - 1

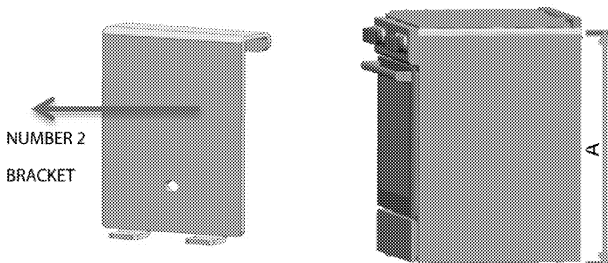
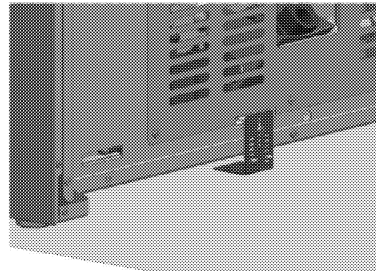
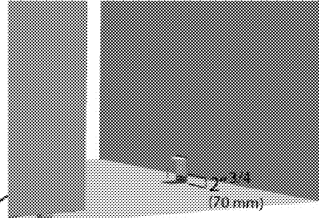

PICTURE - 2

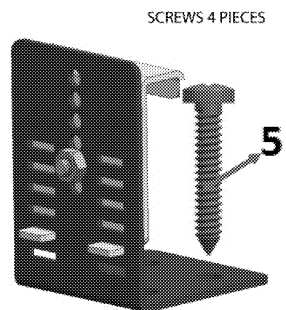
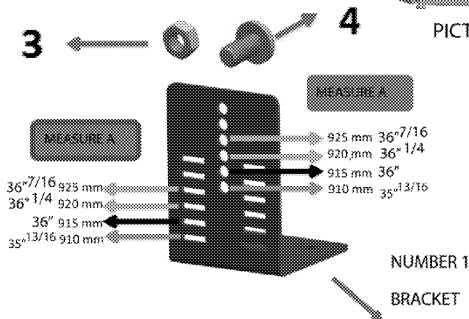

## How to move the appliance

Movement of your appliance is most easily achieved by lifting the front as indicated in the drawing. Open the oven door sufficiently to allow a comfortable and safe grip on the underside of the oven roof avoid causing any damage to the grill element or any internal parts of the oven. Do not move by pulling on the door handle or knobs. Move the appliance a bit at a time until placed in the position required.

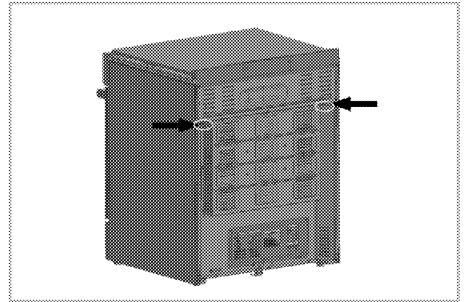
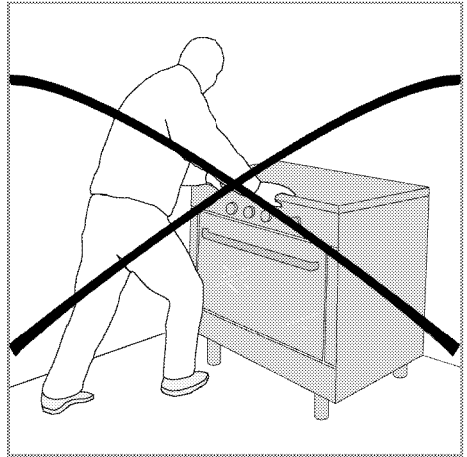
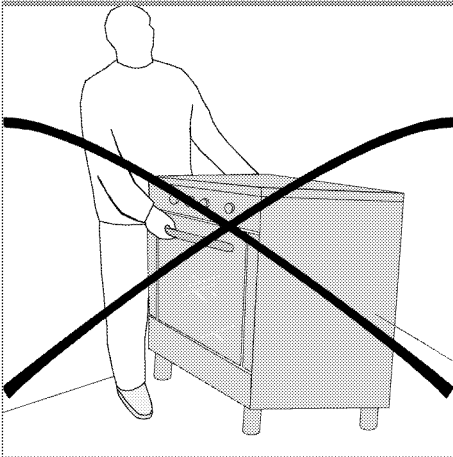
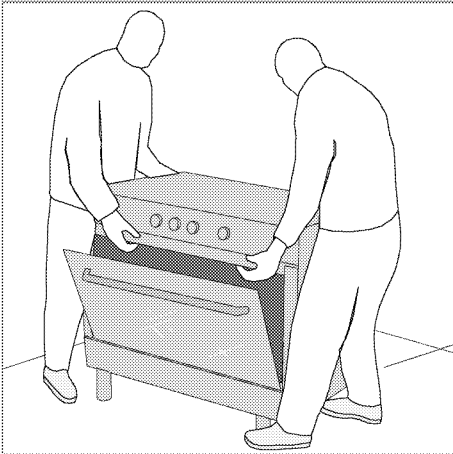

### **WARNING: Tip Over Hazard**

A child or adult can tip the range and be killed. Connect anti-tip bracket to anti-tip hole at the back of the range. Reconnect the anti-tip bracket, if the range is moved. Failure to follow these instructions can result in death or serious burns to children and adults.



### **WARNING: Electrical shock hazard!**

- Use extreme caution when drilling holes into the wall or floor. There may be concealed electrical wires located behind the wall or under the floor.
  - Identify the electrical circuits that could be affected by the installation of the Anti Tip Device, then turn off power to these circuits.
- Failure to follow these instructions may result in electrical shock or other personal injury.**

The California Safe Drinking Water and Toxic Enforcement Act requires the Governor of Cali-

ifornia to publish a list of substances known to the State of California to cause cancer, birth defects, or other reproductive harm, and requires businesses to warn of potential exposure to such substances.

 **WARNING:** This product can expose you to chemicals including Nickel (Metallic) which is known to the State of California to cause cancer. For more information go to [www.P65Warnings.ca.gov](http://www.P65Warnings.ca.gov)  
Note: Nickel is a component in all stainless steel and some other metal components.

 **IMPORTANT:** This product contains a chemical known to the State of California to cause cancer, birth defects, or other reproductive harm.

The fiberglass insulation in self-clean ovens gives off a very small amount of carbon monoxide, benzene, formaldehyde and toluene during the cleaning cycle. Exposure can be minimized by venting with an open window or using ventilation fan or hood.

### Connection to the main supply

 **IMPORTANT:** Electrical installation should comply with national and local codes.

 **IMPORTANT:** This appliance must be grounded!

 **WARNING**  
Avoid fire hazard or electrical shock. Do not use an adapter plug, an extension cord, or remove grounding prong from electrical power cord, have a qualified electrician install an outlet near the appliance. Failure to follow this warning can cause serious injury, fire or death.

 **WARNING**  
Risk of Electric Shock or Fire. Grounding through the neutral conductor is prohibited for new branch circuit installations (1996 NEC), mobile homes, and recreational vehicles, or in an area where local codes prohibit grounding through the neutral conductor.

Before starting any work the electrical installation, the electrical power to the range must be shut off while line connections are being made.

Failure to follow these instructions can result in death, fire, or electrical shock.

### Provide Electrical connection

Install the junction box under the cabinet and run 120/240 or 120/208 Volt, AC wire from the main circuit panel. DO NOT connect the wire to the circuit panel at this time.

### Electrical requirements

This appliance must be supplied with the proper voltage and frequency and connected to an individual, properly grounded branch circuit, protected by a circuit breaker or fuse. A circuit breaker or fuse is required by your appliance. The circuit breaker or fuse amperage recommended for your appliance is 40A or 50A.

### Observe all governing codes and local ordinances

A 3 wire or 4 wire single phase 120/240 or 120/208 Volt, 60 Hz AC only electrical supply is required on a separate circuit fused on both sides of the line (red and black wires). A time-delay fuse or circuit breaker is recommended. DO NOT fuse neutral (white wire).

NOTE: Wire sizes and connections must conform with the fuse size and rating of the appliance in accordance with the American National Electrical Code ANSI/ NFPA No. 70-latest edition.

 **IMPORTANT:** This appliance must be properly grounded to avoid shock hazard!

Our company shall not held responsible for any damage caused by using the appliance without grounded receptacle.

This range must be electrically grounded in accordance with local codes, or in their absence, with the National Electrical Code ANSI/NFPA No. 70-latest edition in United States. Installation should be made by a Licensed electrician.

**WARNING:**  
 Risk of electric shock, short circuit or fire by damage of the main power supply!  
 The main power supply lead must not be clamped, bent or trapped or come into contact with hot parts of the appliance. If the main power cable is damaged, it must be replaced by a qualified electrician.

This range may be connected by means of permanent "hard wiring" (flexible armored or nonmetallic shielded copper or aluminum cable), or by means of a power supply cord kit. Only a power supply cord kit rated at 120/ 240 volts and 40 or 50 amperes terminating in tinned leads and marked for use with ranges shall be used. If a 50 Ampere cord is used it must be marked for use with a 1 3/8 inches (35 mm) diameter opening. Cord must have either 3 or 4 conductors to match electric receptacle (Use copper or Aluminum Conductors).

**WARNING:**  
 Risk of fire or electrical shock exists if an incorrect size appliance cord kit is used or the installation manual or strain relief clamp are disregarded.

**WARNING:**  
 Do not loosen the nuts which secure the factory-installed range wiring to the terminal block while connecting range. Electrical failure or loss of electrical connection may occur.

When installed where it is not permitted to ground through the neutral, a 4-conductor cord must be used or cable assembly. See manufacturer's instructions.

The main supply data must correspond to the data specified on the rating plate of the appliance. The rating plate is either seen when the door is opened.

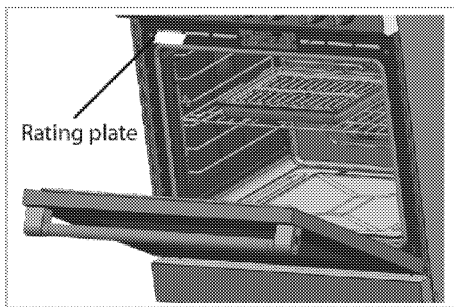

### 3 & 4 -wire electrical wall receptacle types & recommended mounting orientation on wall

Figure A illustrates 4-wire receptacle required for new branch circuit installation (1996 NEC) mobile homes, and recreational vehicles or where local codes do not allow grounding thru the neutral. Figure B illustrates 3-wire receptacle that is allowed in areas that allow grounding through neutral.

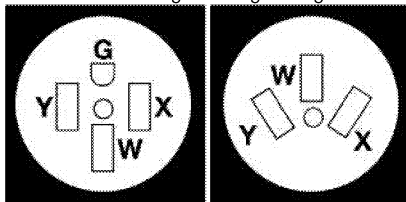

A) 4-wire wall receptacle

B) 3-wire wall receptacle (10-50R)

### Access to terminal block

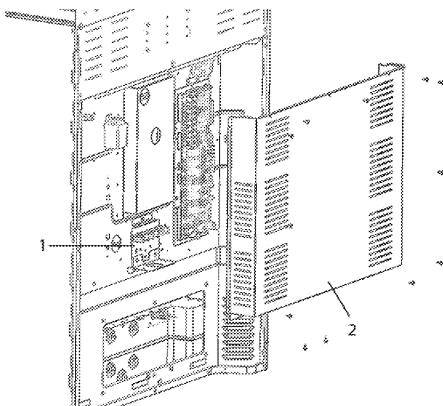

- 1 Terminal block
- 2 Cover

Loosen the screws on rear access cover and take off the terminal block cover.

After completing connections put terminal block cover to the original location and tighten the screws.

### Power cord connections



#### WARNING

Risk of electric shock!

Frame grounded to neutral of appliance through a link. Grounding through the neutral conductor is prohibited for new branch-circuit installations (1996 NEC); mobile homes; and recreational vehicles, or in an area where local codes prohibit grounding through the neutral conductor. For installations where grounding through the neutral conductor is prohibited:

- a- Disconnect the link from the neutral;
  - b- Use grounding terminal or lead to ground unit; and
  - c- Connect neutral terminal or lead to branch circuit neutral in usual manner (when the appliance is to be connected by means of a cord kit, use 4-conductor cord or conduit for this purpose) See fig.9.
- Do not use an extension cord.



#### IMPORTANT:

Do not loosen the factory installed nut connections which secure the range wiring to terminal block. Electrical failure or loss of electrical connection may occur if these 3 nuts are loosened or removed.

### Power cord

#### Train relief installation

A ground strap is installed on this range which connects the center terminal of the neutral terminal block to the range chassis. The ground strap is connected to the range by the center, lowest screw. See Figure 9. The ground strap must not be removed unless National, State or Local Codes do not permit use of a ground strap.

Note: If the ground strap is removed for any reason, a separate ground wire must be connected to the separate ground screw attached to the range chassis and to an adequate ground source.

3 & 4-wire permanent wire connections

3-wire permanent connection - follow steps in, 2 and 5 below. 4-wire permanent connection — follow all steps below.

Before wiring the range, review the suggested power source location drawings in Figure 2. If connecting to a 4-wire electrical system

1. Follow the manufacturer's Installation Instructions supplied with the strain relief clamp and install.
2. Strip insulation away from the ends of the permanent wiring for line 1, line 2 and neutral; also strip ground wire on 4-wire connections. Tighten all 3 or 4-wire leads to the terminal block. Follow wire locations shown in Figure 10.

**IMPORTANT DO NOT LOOSEN** the factory installed at connections which secure the range wiring to the terminal block. Electrical failure or loss of electrical connection may occur if these 3 nuts are loosened or removed.

Note: For 3-wire permanent connection skip steps 3 and 4 and continue with step 5.

3. Disconnect the ground strap. Remove the factory installed ground screw and plate to release the factory installed copper ground strap from frame of the range. Cut and discard the copper strap from the terminal block. KEEP the ground screw, ground plate and go to step 4.
4. Connect the green ground wire lead to the frame of the range using the ground screw and plate as shown in Figure . Be sure to install using the same hole in the frame where the ground screw was originally installed.
5. Make sure all connections are tightened securely and replace the rear access cover. See Figure .  
Note: Non-terminated field wire compression connections must be set at approximately 90 in./lbs.



### 4-wire connection

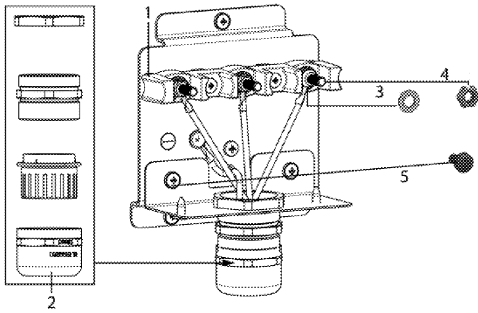

- 1 Terminal block
- 2 Power cord/conduit plate
- 3 Washer
- 4 Nut
- 5 Screw

### 3-wire connection

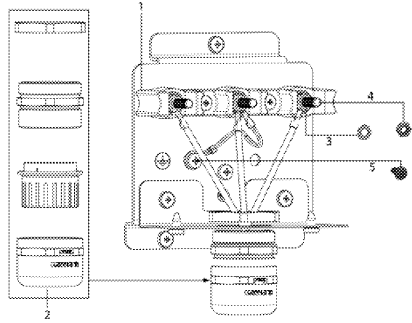

- 1 Terminal block
- 2 Power cord/conduit plate
- 3 Washer
- 4 Nut
- 5 Screw

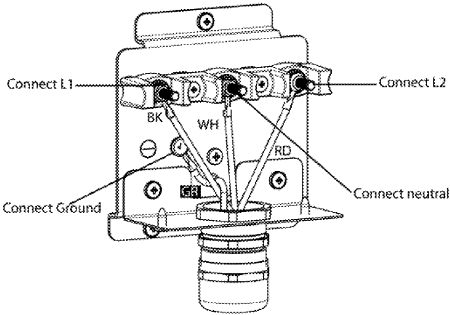

- BK Black
- WH White
- RD Red
- GR Green

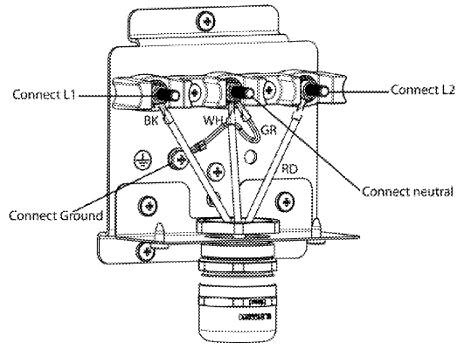

- BK Black
- WH White
- RD Red
- GR Green

### 3 Preparation



#### Tips for saving energy

The following information will help you to use your appliance in an ecological way, and to save energy:

- Use dark colored or enamel coated cookware in the oven since the heat transmission will be better.
- While cooking your meals, perform a preheating operation if it is advised in the user manual or cooking instructions.
- During cooking, do not open the oven door frequently.
- Try to cook more than one type of meal with in the oven at the same time (You can cook two different meals at the same time by locating cooking bowls on the same shelf). It will be suitable to cook more than one meal after each other. The oven will already be hot.
- Defrost frozen meals before cooking them.
- You can save energy by switching off your oven a few minutes before the end of the cooking time. (The oven door should not be opened).
- Use pots/pans with lids for cooking, without a lid, the energy consumption may be up to 4 times higher.
- Choose the burner/plate which is suitable to the saucepan base. Always choose the correct size of saucepans for your meals. For larger burners/plates more energy is needed.
- Take care to use flat base saucepans while cooking on electrical cookers.
- Pots with an even and thick bottom provide better thermal conduction. You can save up 1/3 of electricity.
- Pots and pans should match the size of plates. The bottom of the pot or pan should not be smaller than the plate.
- Keep plates and pan bottoms clean, dirt will reduce the heat transmission between plate and pan bottoms.
- In case of longer cooking times, switch off the plate 5 to 10 minutes before the end of

the cooking time. When you use the residual heat, you can save up to 20 % of electricity.

#### First cleaning of the appliance

	<b>IMPORTANT:</b> When removing appliance for cleaning and/or service; Disconnect AC power supply. Carefully remove the range by pulling outward. Range is heavy, use care in handling.
	The surface might get damaged by some detergents or cleaning materials. Do not use aggressive detergents, cleaning powders/creams or any sharp objects during cleaning. Be careful to avoid steam burn. Some cleaners can produce noxious fumes if applied to a hot surface.

1. Remove all packaging materials.
2. Wipe the surfaces of the appliance with a damp cloth or sponge and dry with a cloth.

#### Initial heating

	<b>IMPORTANT:</b> Smoke and smell may emit for a couple of hours during the initial operation. This is quite normal. Ensure that the room is well ventilated to remove the smoke and smell. Avoid directly inhaling the smoke and the smell that emits.
-----------------------------------------------------------------------------------	------------------------------------------------------------------------------------------------------------------------------------------------------------------------------------------------------------------------------------------------------------

Heat up the product for about 30 minutes and then switch it off. Thus, any production residues or layers will be burnt off and removed.

	<b>WARNING</b> Hot surfaces cause burns! Product may be hot when it is in use. Never touch the hot burners, inner sections of the oven, heaters and etc. Keep children away. Always use heat resistant oven gloves when putting in or removing dishes into/from the hot oven.
-------------------------------------------------------------------------------------	-------------------------------------------------------------------------------------------------------------------------------------------------------------------------------------------------------------------------------------------------------------------------------------

#### Electric oven

1. Take all baking trays and the wire grill out of the oven.
2. Close the oven door.
3. Select the bake function.
4. Set the temperature 175 °C (350° F).

5. Operate the oven about 30 minutes.
6. Turn off your oven.

### **Broil**

1. Take all baking trays and the wire grill out of the oven.
2. Select the broil function.
3. Set the broil level to "HI".
3. Operate the broil about 30 minutes.
4. Turn off your oven.



Smoke and smell may emit for a couple of hours during the initial operation. This is quite normal. Ensure that the room is well ventilated to remove the smoke and smell. Avoid directly inhaling the smoke and the smell that emits.

## 4 How to use the hob

### General information about cooking



#### DANGER

##### Risk of fire over by overheated oil!

When you heat oil, do not leave it unattended.



#### WARNING

Do not use water on grease fires. Never pick up a flaming pan. Turn the controls off. Smother a flaming pan on a surface unit by covering the pan completely with a well-fitting lid or a fire blanket, cookie sheet or flat tray. Use a multi-purpose dry chemical or foam-type fire extinguisher.



#### WARNING

Do not place or store items that can melt or catch fire on the glass cook top, even when it is not being used. If the cook top is inadvertently turned on, they may ignite. Heat from the cook top or oven vent after it is turned off may cause them to ignite also.

- Always position pans centrally over the heating element. When transferring pans from one heating element to another always lift the pans do not slide them.
- Before frying foods, always dry them well and gently place into the hot oil. Ensure complete thawing of frozen foods before frying.
- Do not cover the vessel you use when heating oil.
- Place the pans and saucepans in a manner so that their handles are not over the hob to prevent heating of the handles. Do not place unbalanced and easily tilting vessels on the hob.
- Do not place empty vessels and saucepans on cooking zones that are switched on. They might get damaged.
- Operating a cooking zone without a vessel or saucepan on it will cause damage to the product. Turn off the cooking zones after the cooking is complete.
- As the surface of the product can be hot, do not put plastic and aluminum vessels on it.

Clean any melted such materials on the surface immediately.

Such vessels should not be used to keep foods either.

- Use flat bottomed saucepans or vessels only.
- Put appropriate amount of food in saucepans and pans. Thus, you will not have to make any unnecessary cleaning by preventing the dishes from overflowing.  
Do not put covers of saucepans or pans on cooking zones.
- Place the saucepans in a manner so that they are centered on the cooking zone. When you want to move the saucepan onto another cooking zone, lift and place it onto the cooking zone you want instead of sliding it.



#### WARNING

Never leave surface units unattended at high heat settings. Boil over causes smoking and greasy spillovers that may ignite.

- Make sure reflector pans or drip bowls are in place. Absence of these pans or bowls during cooking may subject wiring or components underneath to damage.

#### Tips for glass ceramic plate

- The glass ceramic surface is heat-resistant and insensitive to large temperature deviations.
- Do not use the glass ceramic plate for keeping objects or as cutting surface.



#### WARNING

Do not cook popcorn in prepackaged aluminum containers on the cook top. They could leave aluminum marks that cannot be removed completely.

- Use pot and pans with ground bottoms. Sharp edges cause scratches on the surface.
- Do not use aluminum pots and pans. Aluminum damages the glass ceramic surface.



### WARNING

Glazed cooking utensils - only certain types of glass, glass/ceramic, ceramic, earthenware, or other glazed utensils are suitable for range-top service without breaking due to the sudden change in temperature.

- For foods containing sugar in any form, clean up all spills and soils as soon as possible. Allow the cook- top to cool down slightly. Then, while wearing oven mitts, remove the spills while the surface is still warm. If sugary spills are allowed to cool down, they can adhere to the cook-top and can cause pitting and permanent marks.



### WARNING

Use pot and pans with ground bottoms. Sharp edges cause scratches on the surface.



### WARNING

Avoid scratching the glass cook top. The cook top can be scratched with items such as knives, sharp instruments, rings or other jewelry and rivets on clothing.



### WARNING

If a wet sponge or cloth is used to wipe spills on a hot cooking area, be careful to avoid steam burn. Some cleaners can produce noxious fumes if applied to a hot surface. Utensil handles should be turned inward and not extend over adjacent Face units. To reduce the risk of burns, ignition of flammable materials, and spillage due to unintentional contact with the utensil, the handle of a utensil should be positioned so that it is turned inward, and does not extend over adjacent surface units.



### DANGER

#### Tipping of pan

Make sure that the handles of cookware do not stick out over the edge of the appliance, to avoid them being knocked over by accident. This also makes it more difficult for children to reach the cooking pans.

- Ensure handles of pans cannot accidentally be caught or knocked and do not get hot by adjacent heating zones. Avoid pans that are unstable and easily tipped. Pans that are too

heavy to move easily when filled can also be a hazard.



### WARNING

Do not store items of interest to children in cabinets above a range or on the back guard of a range – children climbing on the range to reach items could be seriously injured.

### Saucepan selection

- Glass ceramic surface is heatproof and is not affected by big temperature differences.
- Do not use the glass ceramic surface as a place of storage or as a cutting board.
- Use only the saucepans and pans with machined bottoms. Sharp edges create scratches on the surface.

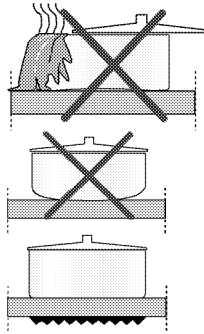

Spills may damage the glass ceramic surface and cause fire.

Do not use vessels with concave or convex bottoms.

Use only the saucepans and pans with flat bottoms. They ensure easier heat transfer.

### For induction hobs, use only vessels suitable for induction cooking.

#### Saucepan test

Use following methods to test whether your saucepan is compatible with the induction hob or not.

1. Your saucepan is compatible if its bottom holds magnet.
2. Your saucepan is compatible if "L" does not flash when you place your saucepan on cooking zone and start the hob.

You can use steel, teflon or aluminium saucepans with special magnetic bottom that contains labels or warnings indicating that the saucepan is compatible with induction cooking. Glass and ceramic vessels, pots and the stainless steel

vessels with non-magnetic aluminium bottom should not be used.

### Saucepan recognition-focusing system

In induction cooking, only the area covered by the vessel on the relevant cooking zone is energised. The vessel's bottom is recognised by the system and only this area is heated automatically. Cooking stops if the cooking vessel is lifted from the cooking zone during cooking. Selected cooking zone and "L" symbol flashes alternately.

### Safe use

Do not select high heating levels when you will use a non-sticking (teflon) saucepan with no oil or with very little oil.

Do not put metal items such as forks, knives or saucepan covers onto your hob since they can get heated.

Never use aluminium foil for cooking. Never place food items wrapped with aluminium foil onto the cooking zone.



If there is an oven under your hob and if it is running, sensors of the hob can decrease the cooking level or turn off the oven.



When the hob is running, keep items with magnetic properties such as credit cards or cassettes away from the hob.

### Selecting cooking zone suitable to the vessel

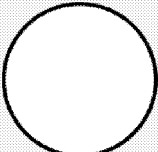
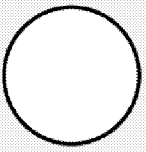
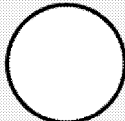
Large cooking zone	Normal cooking zone	Small cooking zone
<p>26 cm / 11"</p> 	<p>21 cm / 9"</p> 	<p>14,5 cm / 6"</p> 
<p><b>Large cooking zone</b></p> <ul style="list-style-type: none"> <li>Automatically fits to the saucepan.</li> <li>Distributes the power ideally.</li> <li>Provides perfect heat distribution. Used to cook dishes such as large crepes or large fishes rare or very rare.</li> </ul>	<p><b>Normal cooking zone</b></p> <ul style="list-style-type: none"> <li>Automatically fits to the saucepan.</li> <li>Distributes the power ideally.</li> <li>Provides perfect heat distribution. Used for all kinds of cookings.</li> </ul>	<p><b>Small cooking zone</b></p> <ul style="list-style-type: none"> <li>Used for slow cookings (sauces, creams)</li> <li>Used to prepare small portions or portions based on number of persons.</li> </ul>

## Using the burners/plates



### DANGER:

Avoid scratching or impacting glass doors, cook tops or control panels. Doing so may lead to glass breakage. Do not cook on a product with broken glass. Shock, fire or cuts may occur.

Do not let any objects fall onto the plate. Even small objects (e.g. salt shaker) may damage the burner/ plate.



### DANGER:

Do not use glass surface with cracks. Water may enter into the cracks and cause a short circuit.



### DANGER:

If the surface is damaged in any way (e. g. visible cracks), switch off the device immediately to reduce the risk of an electric shock.  
If cooktop should break, cleaning solutions and spillovers may penetrate the broken cooktop and create a risk of electric shock. Contact a qualified technician immediately.

## Using the hobs



### DANGER

**Broken glass!**  
Do not let any objects fall onto the hob. Even small objects (e.g. salt shaker) may damage the hob.  
Do not use glass ceramic hobs with cracks. Water may enter into the cracks and cause a short circuit.  
If the surface is damaged in any way (e. g. visible cracks), switch off the device immediately to reduce the risk of an electric shock.

## Turning on the cooking zones



Graphics and figures are for informational purposes only. Actual displays and functions may vary according to the model of your hob.

Turning the hob control knob counterclockwise the power of the according cooking zone can be increased. To reduce the power of the cooking zone again it is necessary to turn the hob control knob clockwise.

The current power level is on the display unit of the hob.

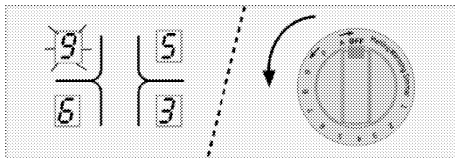

## Turning off the cooking zones:

The hob control knob is turned from the locked "OFF" position to switch a cooking zone on as well as when the hob control knob is turned back to the OFF position to switch a cooking zone off.



If all knobs are turned to OFF locked position the display disappears after several times. If a buzzer is implemented a signal is played when the control is switched off.

## Cooking levels

There are 10(1-9 level with booster(p)) cooking levels on the hob control hobs. Additionally the hob has 3 different cooking levels as melting, warming and simmer.

Level	Symbol	Temperature (°F/°C)
melting	"☉" symbol flashes	107/42
warming	"☽" symbol flashes	158/70
simmer	"☼" symbol flashes	201/94



The melting and warming levels can be defined dependently of variant. The simmer level 94°C (201°F) is fixed temperature value.

## Residual heat indicator

"H" symbol that appears on the cooking zone display indicates that the hob is still hot and may be used to keep a small amount of food warm. The symbol will disappear when the cooking zone cools down or when it is activated.



When power is cut off, residual heat indicator will not light up and does not warn the user against hot cooking zones.

## High Power (Booster)

Booster is a function which facilitates cooking. All cooking zones indicated with "P" symbol in the Technical Specifications table are equipped with Booster function.

### Turning on High Power (Booster):

1. Push and turn the related hob control knob counter clockwise to position "P".

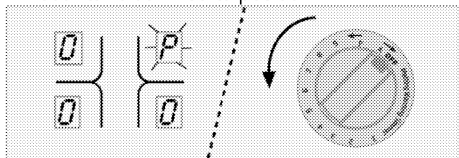

2. Turn the hob control knob in the left overwind position to activate High power (Booster "P"). "P" will appear on related cooking zone display.



The hob will drop to level 9 after several minutes (optional) automatically.



Not each pan suitable to reach the full boost power due its magnetic and electrical characteristic.

### Turning off High Power (Booster):

Turn the hob control knob in the left overwind position to turn off High power (Booster "P"). "9" will appear on related cooking zone display.

## Child Lock

You can protect the hob by child lock to prevent children from changing hob functions.

### Activating the Child Lock

1. Turn the first two hob control knobs from the left simultaneously in to the right overwind and hold in that position at least 2 second.  
» Child lock function will be activated.

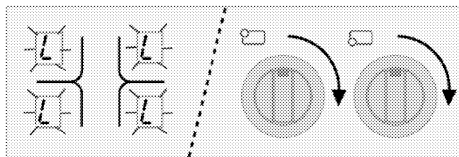

If any key is pressed when the child lock is active, "L" symbol will appear on cooking zone displays.

## Deactivating child lock

Turn the first two hob control knobs from the left simultaneously in to the right overwind and hold in that position at least 2 second.

Child lock function will be deactivated.



If the hob is turned off and on in this condition, child lock will be still active.



If any hob control knob was in a position different from "OFF", after unlocking all hob control knobs have to be turned back in the "OFF" position

## Quick Heating Function

Quick heating is a function which facilitates cooking. All cooking zones are equipped with Quick heating function. This function can be operated by setting temperature level beforehand.

### Turning on Quick Heating Function:

1. Turn the related hob control knob in to the right overwind and hold in that position at least 2 second.  
» "A" will appear on related cooking zone display.

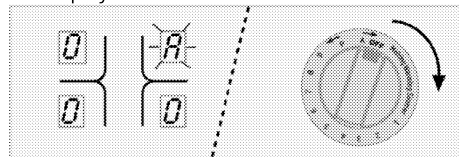

2. Turn the hob control knob counter-clockwise to set heating level (it is supposed that level 7 is selected for the example).

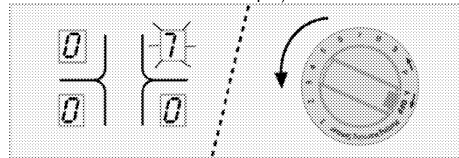

- » "A" and "7" will appear on related cooking zone display alternately.



Within the next 10 seconds a valid cooking level has to be selected.



When the Quick operation time is up, the hob will continue operating at the set temperature level.



### Turning off Quick Heating Function:

The hob control knob is turned from the locked "Off" position to turn off the Quick Heating function.

**Table:** Quick Heating Operation Times

Temperature level	Quick Heating Operation Times - Second
0	0
melting	-
warming	-
simmer	-
1	48
2	144
3	230
4	312
5	408
6	120
7	168
8	216
9	-

### Using induction cooking zones safely and efficiently

**Operating principles:** Induction hob heats directly the cooking vessel as a feature of its operating principles. Therefore, it has various advantages when compared to other hob types. It operates more efficiently and the hob surface does not heat up.

Induction hob is equipped with superior safety systems that will provide you maximum usage safety.



Your hob can be equipped with induction cooking zones with a diameter of 145 (6"), 210 (9") and 260(11") mm depending on the model. With induction feature, each cooking zone detects each vessel placed on them. Energy builds up only where the vessel contacts with the cooking zone and thus, minimum energy consumption is achieved.

### Operation time constraints

The hob control is equipped with an operation time limit. When one or more cooking zones are left on, the cooking zone will automatically be deactivated after a certain period of time (see Table-1). If there

is a timer assigned to the cooking zone, the timer display will also turn off later.

Operation time limit depends on the selected temperature level. Maximum operation time is applied at this temperature level.

The cooking zone may be restarted by the user after it is turned off automatically as described above.

**Table-1:** Operation time limits

Temperature level	Operation time limit - minutes
0	0
Melting	120
Warming	120
Simmer	120
1	360
2	360
3	300
4	300
5	240
6	90
7	90
8	90
9	90
Booster	10 (*)

(\*) The hob will drop to level 9 after 10 minutes (optional)

### Overheating protection

Your hob is equipped with some sensors ensuring protection against overheating.

Following may be observed in case of overheating:

- Active cooking zone may be turned off.
- Selected level may drop. However, this condition cannot be seen on the indicator.
- E2 error might be given.

### Power management

The power management is independently done by the induction system. The latest set cooking level has priority. If it is not possible to output the required power on a cooking zone it will not be displayed. The display changes only when the actual cooking level is reached by turning the knob left.

### Precise power setting

Induction hob reacts the commands immediately as a feature of its operating principles. It changes the power settings very fast. Thus, you can prevent a cooking pot (containing water, milk and

etc.) from overflowing even if it was just about to overflow.

### Operating noisy



Some noises may arise from the induction hob. These sounds are normal and a part of induction cooking.

- Noise becomes prominent in high temperature levels.
- Alloy of the saucepan can cause noise.
- In low levels, a regular on/off sound can be heard because of the operating principles.
- Noise can be heard if an empty saucepan is heated. When you put water or food in it, this sound will clear away.
- The noise of the fan that cools electric system can be heard.

### Error messages

**Table-2:** Error codes and error sources

Cause of error	Indicator	Display
Overheat error	"E2" symbol flashes	Cooking zone display
Hob overheated	"H" symbol flashes	Cooking zone display
Mains errors	"E6" symbol flashes	Cooking zone display
Sensor failure	"E9" symbol flashes	Cooking zone display
Permanent use of knobs	"  " symbol flashes	Cooking zone display
Incorrect fan speed	"E8" symbol flashes	Cooking zone display
Component failure	"EA" symbol flashes	Cooking zone display
Inapplicable pot	"E3" symbol flashes	Cooking zone display
Cooking zone does not exist	"E4" symbol flashes	Cooking zone display
Error on filter board	"E5" symbol flashes	Cooking zone display

	For further information about error messages that may appear on the touch control panel, see Table-2.
	If the surface of the touch control panel is exposed to intense vapor, entire control system may become deactivated and give error signal.
	Keep the surface of the touch control panel clean. Erroneous operation may be observed.

## 5 How to operate the oven

### General information on baking, roasting and broiling



#### WARNING

Hot surfaces cause burns!  
Product may be hot when it is in use. Never touch the hot burners, inner sections of the oven, heaters and etc. Keep children away. Always use heat resistant oven gloves when putting in or removing dishes into/from the hot oven.



#### DANGER:

Be careful when opening the oven door as steam may escape.  
Exiting steam can scald your hands, face and/or eyes.

### Tips for baking

- Use non-sticky coated appropriate metal plates or aluminum vessels or heat-resistant silicone moulds.
- Make best use of the space on the rack.
- Place the baking mould in the middle of the shelf.
- Select the correct rack position before turning the oven or Broil on. Do not change the rack position when the oven is hot.
- Always place oven racks in desired location while oven is cool. If rack must be moved while oven is hot, do not let potholder contact hot heating element in oven.
- Keep the oven door closed.

### Tips for roasting

- Seasoning with lemon juice and black pepper will improve the cooking performance when cooking a whole chicken, turkey or a large piece of meat.
- Meat with bones takes about 15 to 30 minutes longer before it is cooked than a roast of the same size without bones.
- You should calculate about 4 to 5 minutes cooking time per centimeter height of the meat.
- Let meat rest in the oven for about 10 minutes after the cooking time. The juice is better distributed all over the roast and does not run out when the meat is cut.

- Fish in a fire-resistant dish should be placed on the rack at the medium or lower level.

### Tips for broiling

Broiling is ideal for cooking meat, fish and poultry and will achieve a nice brown surface without it drying out to much. Flat pieces, meat skewers and sausages are particularly suited for broiling as are vegetables with a high water content such as tomatoes and onions.

- Distribute the pieces to be broiled on the wire shelf.
- If the broiling is on the wire shelf, locate a dripping pan under it in order to collect the fat.
- Add some water in dripping pan for easy cleaning.



#### Fire danger due to food which is unsuitable for grilling!

Only use food for grilling which is suitable for intensive grilling heat.  
Do not place the food too far in the back of the grill. This is the hottest area and fat food may catch fire.



#### WARNING

Do not insert your finger or any other object in the holes of the back wall of the oven.



Fan only runs if necessary for improving performance of cooking and saving the energy of the oven.

### Tips for cooking vegetables

1. If the vegetable dish runs out of juice and gets to dry,  
» Since using a lid during cooking will keep the juice of the dish in the pan, cook your vegetable dishes in a pan with a lid instead of a tray.
2. If a vegetable dish does not get cooked,  
» Boil the vegetables beforehand or prepare them like canned food and put in the oven.

### Shelf positions

For optimum broil coverage, position the wire shelf towards the front of the oven just out of contact with the glass door. Placing the wire shelf fully to the rear of the oven will reduce the broil coverage. It is important to position the wire shelf on side rack correctly. The wire shelf must be placed so that it

will fit into the opening of the wire shelf as illustrated in the figure.

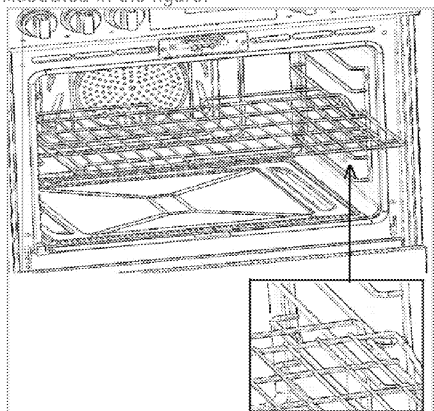

## How to use the electric oven

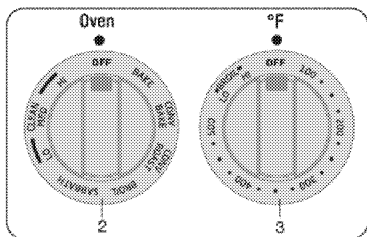
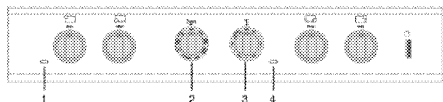

- 1 Function indicator light
- 2 Function knob
- 3 Thermostat knob
- 4 Temperature indicator light

1. Set the Function knob to the desired operating mode. The function indicator light (1) will be ON when you turn the function knob.
2. Set the Temperature knob to the desired temperature.
  - » Oven heats up to the adjusted temperature and maintains it. The temperature indicator light (4) will be ON and the buzzer beeps 3 times for once when the oven has reached the set temperature.

**i** Buzzer has no effect on the oven functions. It is used for information purposes. As soon as the desired temperature you set has reached, the buzzer gives you an audible warning and the temperature indicator light (4) turns ON.

## Switch off the electric oven

1. Turn the function and thermostat knobs to off (upper) position.

## Preheating

Preheating is necessary for selected dishes and this is indicated in the cooking table.

If the oven temperature is below the set temperature, the temperature indicator light (4) is OFF. This indicates that the temperature has not yet reached the desired value.

When the oven reaches the set temperature, the temperature indicator light(4) will be ON and the buzzer beeps 3 times for once.

As long as the temperature does not fall below the set value, the temperature indicator light(4) remains ON.

If the oven temperature drops due to changing the set temperature or opening the oven door, the temperature indicator light(4) turns OFF until it reaches the desired temperature again.

## Cooking Functions

### Bake

Only bottom heat is on. The bake mode can be used for a variety of food items, from cakes to casseroles.

Bake food on a single rack with the pans are positioned in the middle of the oven. Bake foods with 1" (25mm) to 1.5" (38mm) space between pans and oven walls.

When using the Bake mode, preheat the oven for best results.

Baking time will vary with the size, shape and material of the pan used.

### Convection Bake

Only ring heater is on. The heat comes from back of steel plate and is circulated throughout the oven by the convection fan. The convection bake mode can be used for a variety of food items, from cakes to breads.

It is also ideal for sponge cakes, pasties and biscuits on multiple racks (3 and 5) at the same time and large quantities of baked foods.

The cakes are positioned with the top rack cakes towards the back of the oven and the lower rack cakes towards the front of the oven. Bake foods with 1" (25mm) to 1.5" (38mm) space between pans and oven walls.

When using the Convection Bake mode, preheat the oven for best results.

Baking time will vary with the size, shape and material of the pan used.

### Convection Roast

Top and bottom heat are on. The heat comes from top and bottom and is circulated throughout the oven by the convection fan. The convection roast mode can be used for meat, poultry and large quantities of roasted foods.

Roast food on a single rack with the pan is positioned in the middle of the oven.

When using the Convection Roast mode, preheat the oven for best results.

For best performance, use a pan and grid (roasting tray or broiler tray) under the meat or poultry. The pan catches grease spills.

	<b>WARNING</b> Do not cover meat or use roasting bags in this mode.
----------------------------------------------------------------------------------	------------------------------------------------------------------------

### Broil

Top heat is on. The broil mode can be used for cuts of meat, poultry and fish. It can also be used to brown breads. The food must be put on a grid in a pan (broiler tray).

Broil food on a single rack with the broiler tray are centrally located with respect to the heating element.

The broil mode has two settings: low "LO" and high "HI".

When using the Broil mode, preheat the oven 5-6 minutes for best results.









Turn foods once during the recommended cook time.

The size, weight, thickness, starting temperature and personal preference of doneness will affect broiling times.

### Sabbath

Only bottom heat is on.

Cook food on a single rack with the pans are positioned in the middle of the oven. Cook foods with 1" (25mm) to 1" ½ "(38mm) space between pans and oven walls.

	In sabbath mode function indicator light(1) and temperature indicator light (4) remain ON until the end of the program while the mode is running.
	The maximum time for Sabbath mode is 75 hours.
	<b>IMPORTANT:</b> Light is off when the Sabbath function in use. No change in light if you press the button without Sabbath mode.
	<b>WARNING:</b> Food Poisoning Hazard: Do not let food sit in oven for more than 1 hour before or after cooking. Doing so can result in food poisoning or sickness.
	<b>WARNING:</b> To avoid permanent damage to the oven bottom finish do not line the oven bottom with any type of foil or liner.
	<b>WARNING:</b> Sabbath mode should be used only on the Jewish Sabbath and Holidays.
	<b>WARNING:</b> The health of some birds and pets is extremely sensitive to the fumes given off during the Sabbath mode. Always move birds and pets to another closed and well ventilated room. Keep the kitchen well-ventilated during the Sabbath mode also for your health.
	All food should be placed in the oven before the Sabbath begins, since none may be placed in the oven during the Sabbath.
	On the Sabbath the oven door may only be opened once, all the food removed and then closed. On the Holidays, the oven door may be opened/closed at any time as often as desired.

## Cooking times table



1st rack of the oven is the **bottom** rack.



The timings in this chart are meant as a guide. Timings may vary due to temperature of food, thickness, type and your own preference of cooking.

## Baking and roasting

Food	Cooking Mode	Oven Temperature (°F/°C)	Number of Racks	Rack Position	Time (min.)	Pan Size&Type	Explanation
Sponge Cake	Bake	350/175	Single	3	20-30	8" or 9" (200-230 mm) round	The cakes are positioned in the middle of the oven. Bake foods with 1" (25mm) to 1.5" (38mm) space between pans and oven walls.
Sponge Cake	Convection Bake	325/160	Multiple	3&5	20-30	8" or 9" (200-230 mm) round	The cakes are positioned with the top rack cakes towards the back of the oven and the lower rack cakes towards the front of the oven. Bake foods with 1" (25mm) to 1.5" (38mm) space between pans and oven walls.
Loaf (leavened*)	Bake	400/205	Single	3	30-40	Baking tray	-
Loaf (leavened*)	Convection Bake	400/205	Single	3	25-35	Baking tray	-
Puff pastry	Convection Bake	375/190	Multiple	3&5	15-20	Cookie sheet	The sheets are positioned with the top rack sheet towards the back of the oven and the lower rack sheet towards the front of the oven. Bake foods with 1" (25mm) to 1.5" (38mm) space oven walls.
Fresh pizza, thin	Bake	425/220	Single	2	8-15	Pizza pan or Baking tray	-
Fresh pizza, thick	Bake	425/220	Single	2	12-20	Pizza pan or Baking tray	-
Frozen pizza, thick	Bake	425/220	Single	2	10-15	Pizza pan or Baking tray	-
Chicken, whole (4-4.5 lbs.)	Convection Roast	375/190	Single	2	120-140	Roasting pan or broiler tray	Minimum internal temperature is 180°F (82 °C) in thigh
Turkey, whole, unstuffed (18-20 lbs.)	Convection Roast	325/160	Single	1	150-180	Roasting pan	Minimum internal temperature is 180°F (82 °C) in thigh. Foil the top surface of turkey to prevent over-browning in last 30 minutes of the cooking, if necessary.
Sirloin, boneless (4-4.5 lbs.)	Convection Roast	325/160	Single	3	90-120	Broiler tray	Internal temperature is 145°F (62 °C) (medium rare), 160°F (71 °C) (medium)
Toast bread	Broil	High	Single	5	2-2:30	Broiler tray	Place broiler tray centrally located with respect to the heating element.
Chicken thigh (2-2.5 lbs)	Broil	High	Single	4	Side 1: 16-20 Side 2: 8-12	Broiler tray	Place broiler tray centrally located with respect to the heating element. Minimum internal temperature is 180°F (82 °C) in thigh.
Chicken thigh (2-2.5 lbs)	Broil	Mid	Single	4	Side 1: 20-24 Side 2: 14-16	Broiler tray	Place broiler tray centrally located with respect to the heating element. Minimum internal temperature is 180°F (82 °C) in thigh.
Ground beef (0.3"-0.5" thick, 6 patties)	Broil	High	Single	4	Side 1: 5-7 Side 2: 3-5	Broiler tray	Place broiler tray centrally located with respect to the heating element.

Hamburger, frozen (0.3"-0.5" thick, 6 patties)	Broil	High	Single	4	Side 1: 7-10 Side 2: 2-4	Broiler tray	Place broiler tray centrally located with respect to the heating element.
*Leavening	Bake	100/40	Single	3	30-40	Bowl or pan with cover	

\*\*It is suggested to perform preheating for all foods cooking.  
It is suggested to perform 5-6 minutes preheating for all foods broiling.

## How to operate the broil



### WARNING

Hot surfaces may cause burns! Keep children away from the product.  
Close oven door during grilling.

The broil is operated by the function and thermostat knob.

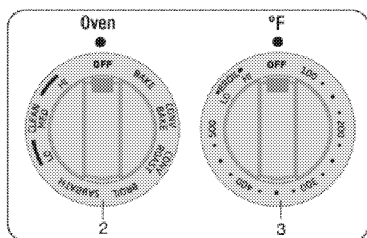
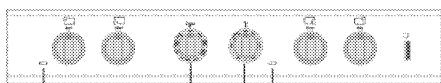

- 1 Function indicator light
- 2 Function knob
- 3 Thermostat knob
- 4 Temperature indicator light

## Switching on Broil

1. Keep the function knob pressed and turn it **clockwise** to the "Broil".
2. Keep the thermostat knob pressed and turn it **clockwise** to the "HI" or "LO" level on "Broil".
3. After 30-75 seconds, the burner will operate.



### CAUTION:

When thermostat knob is turned to the "Broil-LO" or "Broil-HI", functions except "Broil" and "Self-Clean" will not operate.

## Switch off broil

1. Turn the function and thermostat knobs to off (upper) position.

## For equipment with a cooling fan

The cooling fan cools the front of the products.

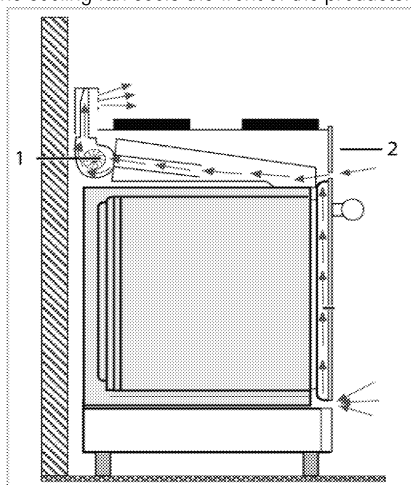

- 1 Cooling fan motor
- 2 Front door



### IMPORTANT:

The cooling fan continues to operate for about 20-30 minutes after the oven is switched off.

## 6 Maintenance and care

### General information

Service life of the product will extend and the possibility of problems will decrease if the product is cleaned at regular intervals.

**DANGER:****Risk of electric shock!**

Switch off the electricity before cleaning appliance to avoid an electric shock.

**DANGER:****Hot surfaces may cause burns!**

Allow the appliance to cool down before you clean it.

**IMPORTANT:**

The surface might get damaged by some detergents or cleaning materials.

Do not use aggressive detergents, cleaning powder/cream or any sharp objects. Do not use aggressive detergents, cleaning powder/cream or any sharp objects.

- Clean the appliance thoroughly after each use; in this way it will be possible to remove cooking residues more easily, thus avoiding these from burning the next time the appliance is used.

**IMPORTANT:**

No special cleaning agents are required for cleaning the appliance. It is recommended to use warm water with washing liquid, a soft cloth or sponge and use a dry cloth for drying.

- **Do not use any abrasive cleaning materials!**



The surface might get damaged by some detergents or cleaning materials.

Do not use aggressive detergents, cleaning powders/creams or any sharp objects during cleaning.

Do not use harsh abrasive cleaners or sharp metal scrapers to clean the oven door glass since they can scratch the surface, which may result in shattering of the glass.

**WARNING:**

Do not use steam cleaners to clean the appliance as this may cause an electric shock.

### Cleaning the burner/plate

#### Ceramic hobs

Always rinse off fully with a clean cloth wrung out in clean water (as residue could damage the ceramic glass surface next time the hob is used). In no case should crusts be scratched off with serrated edge knives, steel wool or the like. Remove calcium stains (yellow staining) with small amounts of decalcifying agents such as Durgol, vinegar or lemon juice.

Do not allow vinegar, coffee, milk, saltwater, lemon or tomato juice to remain in contact with enamel parts (i.e. inside the oven).

Apply agent with a sponge and, in the event of heavier soiling, let it work in for a longer period of time. Afterwards, wash off hob with water.

**WARNING:**

Sugar-based food such as custard and syrup should immediately be scraped off without waiting for the surface to cool down. Otherwise the burner/plate may be permanently damaged.

#### Cleaning the control panel

Clean the control panel and knobs with a damp cloth and wipe them dry.

**IMPORTANT:**

Damage of the control panel!  
Do not remove the control knobs for control panel cleaning.

#### Cleaning the oven

No oven cleaner or any other special cleaning agent is required for cleaning the oven. It is recommended to wipe the oven with a damp cloth while it is still warm.

**WARNING:**

Do not use oven cleaners. No commercial oven cleaner or oven liner protective coating of any kind should be used in or around any part of the oven.



## Self-cleaning function



### WARNING:

If the oven is hot, self cleaning mode can not be operated until the oven is cold. If the self cleaning mode malfunctions (powercut), turn the oven off and disconnect the power supply, and call the service.

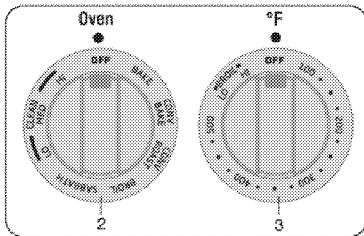
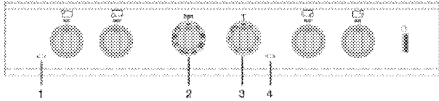

- 1 Function indicator light
- 2 Function knob
- 3 Thermostat knob
- 4 Temperature indicator light



### DANGER:

Hot surfaces cause burns!

Do not touch the product during self cleaning step and keep children away from it. Keep at least 30 minutes before removing the remnants.

The oven is equipped with self-cleaning function. The oven is heated to approx. (790 °F) 421°C and existing dirt is burned to ashes. A strong smoke development may arise. Provide for good ventilation. The self-cleaning should be used after approx. every 10th oven usage.

The self-cleaning has three levels. It can be selected according to level of dirtiness.

**Low (LO):** it takes 3 hours.

**Medium (MED):** it takes 4 hours.

**High (HI) :** it takes 5 hours.

1. Remove all accessories from the oven.
2. Before the self-cleaning cycle, remove dirt from exterior surfaces and oven interior with a damp cloth.



### WARNING:

If the self-cleaning mode malfunctions, turn the oven off and disconnect the power supply. Have it serviced by a qualified technician.



### WARNING:

Before operating the self-clean cycle, Wipe grease and food soils from the oven. Excessive amount of grease may ignite, leading to smoke damage to your home.



### WARNING:

Do not clean the door gasket. Fiberglass gasket is highly sensitive and can get damaged easily. In case of a damage on the oven door gasket, replace with the new one from the authorized service.



### WARNING:

Before operating the self-clean cycle, remove dirt from exterior surfaces and oven interior with a damp cloth, wipe grease and food soils from the oven. Excessive amount of grease may ignite, leading to smoke damage to your home. Remove all accessories from the oven.

3. Keep the function knob pressed and turn it **clockwise** to desired level of "Clean". (LO, MED or HI).

This duration cannot be changed.



In self-cleaning function indicator light(1) and temperature indicator light (4) remain OFF until the end of the program while the mode is running.



### WARNING:

The health of some birds and pets is extremely sensitive to the fumes given off during the Self-Cleaning cycle. Always move birds and pets to another closed and well ventilated room. Keep the kitchen well-ventilated during the Self-Cleaning cycle also for your health.

4. Oven door cannot be opened during self cleaning. It remains locked for a while after the self-cleaning function ends. Do not force the door lock with handle until the oven get cool.
5. After a clean cycle, remove soil deposits with vinegar water.



During the Self-Cleaning cycle, the gas flow to hob burners will be cut. After turning the function and thermostat knob to off position, the door lock will be automatically opened. When the oven gets cool, the gas flow to hob burners will be started.



During the Self-Cleaning cycle, the lamp cannot be operated.



**WARNING:**  
If there is a fire in the oven during self-clean, turn the oven off and wait for the fire to go out. Do not force the door open. Introduction of fresh air at self-clean temperatures may lead to a burst of flame from the oven. Failure to follow this instruction may result in severe burns.

### Clean oven door

To clean the oven door, use warm water with washing liquid, a soft cloth or sponge to clean the product and wipe it with a dry cloth.



Don't use any harsh abrasive cleaners or sharp metal scrapers for cleaning the oven door. They could scratch the surface and destroy the glass.

### Removing the oven door

When removing the oven door, make sure oven is cool and power to the oven has been turned off before removing the door.

Failure to do so could result in electrical shock or burns.

The oven door is heavy and parts of it are fragile. Use both hands to remove the oven door. The door front is glass. Handle carefully to avoid breakage.

Grasp only the sides of the oven door. Do not grasp the handle as it may swing in your hand and cause damage or injury.

Failure to grasp the oven door firmly and properly could result in personal injury or product damage.

To avoid injury from hinge bracket snapping closed, be sure that both levers are securely in place before removing the door. Also, do not force door open or closed—the hinge could be damaged and injury could result.

Do not lay removed door on sharp or pointed

objects as this could break the glass. Lay on a flat, smooth surface, positioned so that the door cannot fall over.

Oven door can be removed in order to clean the inside of oven easily

1. Open the oven door completely.
2. Press the hinge clamps located at both sides of the door backwards.

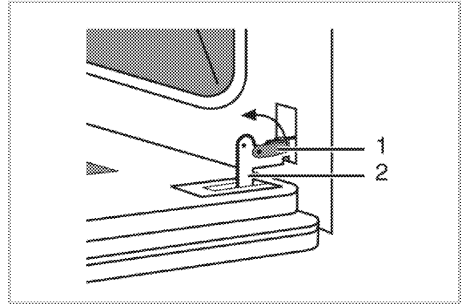

- 1 Hinge clamp
- 2 Hinge

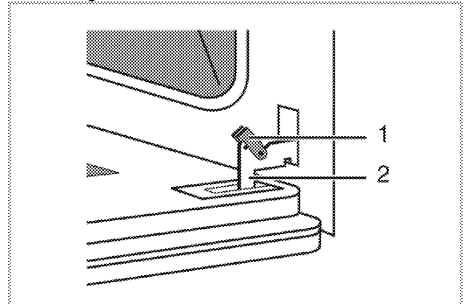

3. Move the oven door to a slightly inclined position.
4. Raise the oven door forwards with your two hands.
5. Once you complete cleaning, perform the same procedure in reverse order to reinstall the oven door.



Once you complete cleaning, perform the same procedure in reverse order to reinstall the oven door.

### Replacing the oven lamp



#### DANGER:

Before replacing the oven lamp, make sure that the product is disconnected from mains and cooled down in order to avoid the risk of an electrical shock.

Hot surfaces may cause burns!

**i** The oven lamp is a special electric light bulb that can resist up to 300°C (573 °F). See *Technical specifications*. for details. Oven lamps can be obtained from Authorised Service Agents or technician with license.

**i** Position of lamp might vary from the figure.

**If your oven is equipped with a square lamp:**

The oven lights can be illuminated with lamp button. The lights are switched on when the door is opened or when the oven is in a cooking cycle. The oven lights are not illuminated during self clean. Each light assembly consist of a removable lens, a light bulb as well as a light socket housing that is fixed in place. Light bulb replacement is considered to be a routine maintenance item.

The oven lights are not illuminated during self clean.

1. Turn off power at the main power supply (your fuse or breaker box).
2. Remove the wire racks as described. See *Cleaning the oven*.

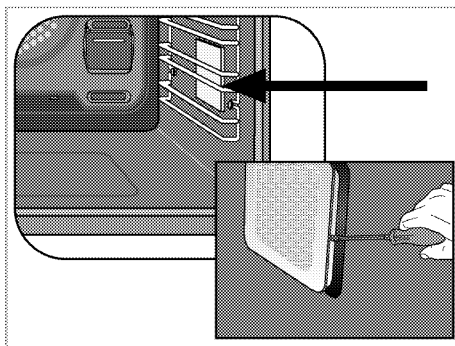

3. Remove the protective glass cover with a screwdriver.
4. Pull out oven lamp and replace it with new one.
5. Install the glass cover and then the wire racks.

## 7 General information

### Overview

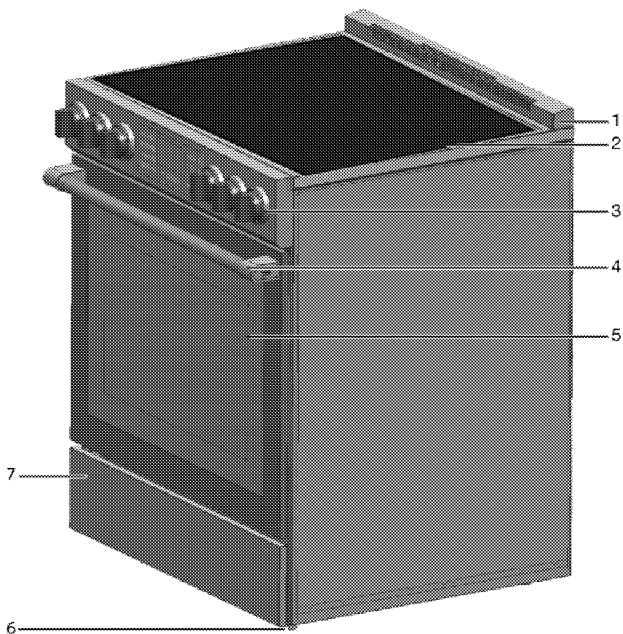

- |   |               |   |            |
|---|---------------|---|------------|
| 1 | Splashback    | 5 | Front door |
| 2 | Burner plate  | 6 | Foot       |
| 3 | Control panel | 7 | Lower part |
| 4 | Handle        |   |            |

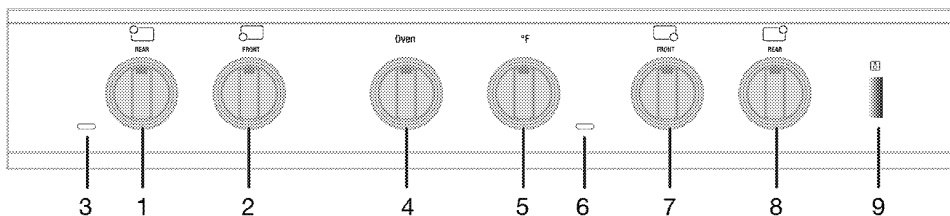

- |   |                                    |   |                                     |
|---|------------------------------------|---|-------------------------------------|
| 1 | Induction cooking plate Rear Left  | 6 | Temperature indicator light         |
| 2 | Induction cooking plate Front Left | 7 | Induction cooking plate Front Right |
| 3 | Function indicator light           | 8 | Induction cooking plate Rear Right  |
| 4 | Function knob                      | 9 | Oven lamp button                    |
| 5 | Thermostat knob                    |   |                                     |

## Technical specifications

GENERAL	
Outer dimensions (height/width/depth)	36 x 29 <sup>13/16</sup> x 29 <sup>1/8</sup> inches (914x757x739 mm)
Voltage / frequency	220- 240V~60Hz 2AC~N
Total electric power	11 kW
Fuse protection	Min. 40 A
Cable type / cross section	SRDT 8/3 + 10/1 AWG
Cable length	max. 6ft
Burners	
Rear left	<b>Induction cooking plate</b>
Size	6 inches (145 mm)
Power	1400/2200 W
Front left	<b>Induction cooking plate</b>
Size	<b>9 inches (210 mm)</b>
Power	2300/3700 W
Front right	<b>Induction cooking plate</b>
Size	6 inches (145 mm)
Power	1400/2200 W
Rear right	<b>Induction cooking plate</b>
Size	<b>11 inches (260mm)</b>
Power	2600/3700 W
Main oven	
Bake	2240 W
Broil	3320 W
Convection Roast	3670 W
Multifunction oven	
Bake	2240 W
Broil	3320 W
Convection Roast	3670 W
<b>* Powers are for 230 V 2AC ~ N</b>	



Technical specifications may be changed without prior notice to improve the quality of the product.



Figures in this manual are schematic and may not exactly match your product.



Values stated on the product labels or in the documentation accompanying it are obtained in laboratory conditions in accordance with relevant standards. Depending on operational and environmental conditions of the product, these values may vary.

## Package contents



### WARNING:

Pull the oven rack to the stop-lock position when loading and unloading food from the oven. This helps prevent burns from touching hot surfaces of the door and oven walls.



### CAUTION:

When you are using a rack in the lowest position (A), you will need to use caution when pulling the rack out. We recommend that you pull the rack out several inches and then, using two pot holders, pull the rack out by holding the sides of it. The rack is low and you could be burned if you place your hand in the middle of the rack and pull all the way out. Be very careful not to burn your hand on the door when using the rack in the lowest position (A).



Accessories supplied can vary depending on the product model. Not every accessory described in the user manual may exist on your product.

1. **User manual**

2. **Oven tray**

Used for pastries, frozen foods and big roasts.

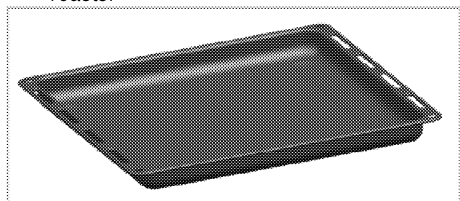

3. **Wire Shelf**

Used for roasting and for placing the food to be baked, roasted or cooked in casserole dishes to the desired rack.

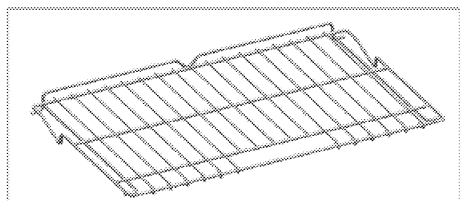

4. **Broiler tray**

It is placed onto the tray in order to collect the dripping fat while grilling so that the oven is kept clean.

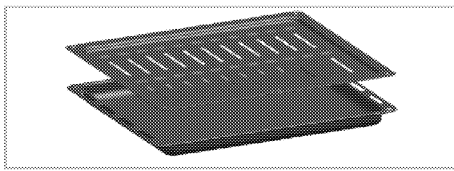
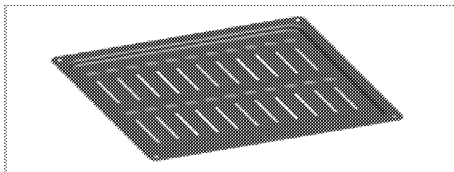

5. **Placing the wire shelf and tray onto the telescopic racks properly**

Telescopic racks allow you to install and remove the trays and wire shelf easily. When using the tray and wire shelf with telescopic racks, make sure that the pins at the rear section of the telescopic rack stands against the edges of the wire shelf and tray.

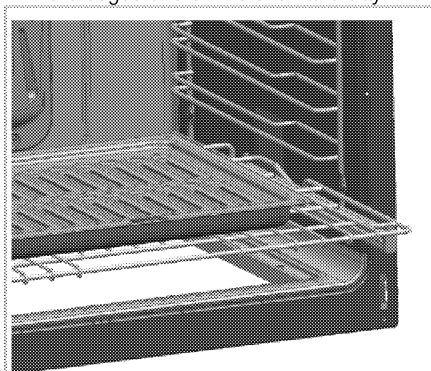

## 8 Troubleshooting

### Oven emits steam when it is in use.

- It is normal that steam escapes during operation. >>> *This is not a fault.*

### Product emits metal noises while heating and cooling.

- When the metal parts are heated, they may expand and cause noise. >>> *This is not a fault.*

### Product does not operate.

- The mains fuse is defective or has tripped. >>> *Check fuses in the fuse box. If necessary, replace or reset them.*
- Product is not plugged into the (grounded) socket. >>> *Check the plug connection.*
- Buttons/knobs/keys on the control panel do not function. >>> *Keylock may be enabled. Please disable it. (See. Using the keylock, page*

### Oven light does not work.

- Oven lamp is defective. >>> *Replace oven lamp.*
- Power is cut. >>> *Check if there is power. Check the fuses in the fuse box. If necessary, replace or reset the fuses.*

### Oven does not heat.

- Function and/or Temperature are not set. >>> *Set the function and the temperature with the Function and/or Temperature knob/key.*
- In models equipped with a timer, the timer is not adjusted. >>> *Adjust the time.* (In products with microwave oven, timer controls only microwave oven.)
- Power is cut. >>> *Check if there is power. Check the fuses in the fuse box. If necessary, replace or reset the fuses.*

### (In models with timer) Clock display is blinking or clock symbol is on.

- A previous power outage has occurred. >>> *Adjust the time / Switch of the product and switch it on again.*



Consult the Authorised Service Agent or the dealer where you have purchased the product if you can not remedy the trouble although you have implemented the instructions in this section. Never attempt to repair a defective product yourself.

## 9 Removing the Package

1

Ribbon

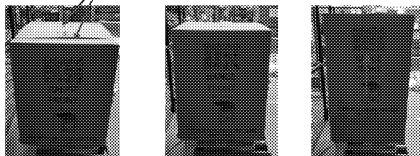

4

Remove nylon bag on the product.



2

Upper Frame

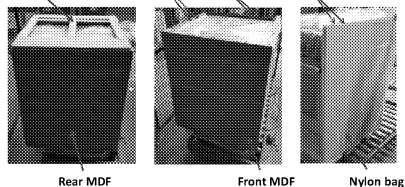

Rear MDF

Front MDF

Nylon bag

A: 18x40 Wooden support

Remove upper frame and rear and front MDFs.

5

Remove styrofoams of the front door.

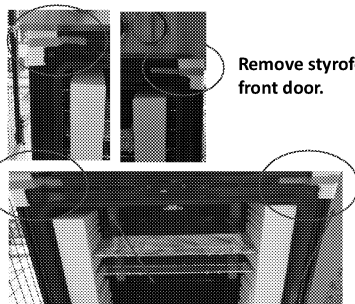

3

Remove cut-out styrofoams and blue tapes.

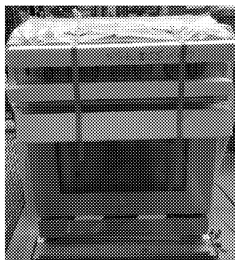

6

Remove grill styrofoams and shrink packaging.

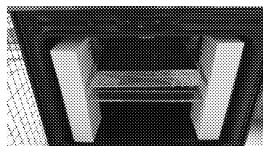



7

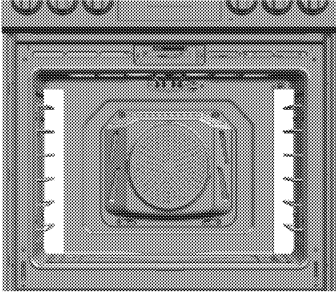

Remove protective styrofoams on rear side.

8

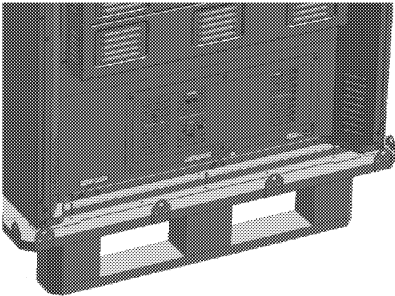

Remove screws.

9

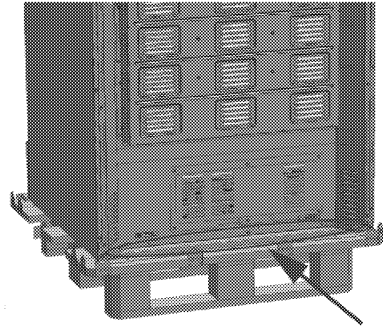

Remove this metal support

10

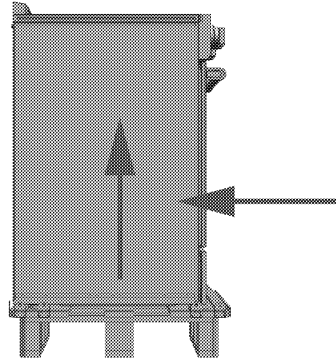

# 10 WARRANTY STATEMENT FOR BLOMBERG ELECTRIC AND GAS RANGES

The warranties provided by Blomberg in these statements only apply to Blomberg electric and gas ranges sold to the original purchaser or homeowner in the US and Canada. This warranty is not transferable.

To obtain warranty service, please contact our nearest distributor as listed by state or call 1800-459-9848. You will need your electric and gas range model number, serial number, retailer name and address, where purchased and purchase date / installation date.

This warranty gives you specific legal rights, and you may also have other rights which vary from state to state.

All warranties stated below are based upon normal household use. The use of the product in a commercial setting will void all warranties.

Service must also be performed by an authorized Blomberg Service Agency.

Cosmetic defects must be reported within 10 business days from installation

1 year \* limited warranty from date of first installation Blomberg will repair or replace at no cost to the consumer any defective parts of the electric and gas ranges

2 year \* ++ limited warranty from date of first installation (Parts only) Blomberg will repair or replace any parts at no cost to the consumer if material defects or workmanship have caused the damage or failure of these components. Labor charges are the responsibility of the consumer

2-5 year \* ++ limited warranty from date of first installation (Parts only) Blomberg will repair or replace oven cavity at no cost to the consumer if material defects or workmanship have caused the damage or failure of these components. Labor charges are the responsibility of the consumer

Disclaimers of warranties and exclusions:

Warranty does not cover service costs by an authorized service agent to correct installation, electrical problems or educational instruction on the use of the electric and gas ranges. The warranty also does not cover defects or damage caused by an act of god (such as storms, floods, fires, mudslides, etc.), damage cause by use of the electric and gas ranges for purposes other than those for which it was designed, misuse, abuse, accident, alteration, improper installation, maintenance, travel fees, service calls outside normal service hours, unauthorized service work or work.

This product is fully tested and went through official quality assurance inspections before leaving the original manufacturing site. Warranty

terms for this Blomberg household appliance is not valid if the product is altered, tampered, modified, additional parts assembled, fixed and re-packed by an authorized distributor, servicer, a third party retailer, reseller or by any other unauthorized person(s).

TO THE EXTENT PERMITTED BY LAW, THIS WARRANTY IS IN LIEU OF ALL OTHER EXPRESSED AND IMPLIED WARRANTIES, INCLUDING THE IMPLIED WARRANTIES OF MERCHANTABILITY AND FITNESS FOR A PARTICULAR PURPOSE. BLOMBERG UNDERTAKES NO RESPONSIBILITY FOR THE QUALITY OF THIS PRODUCT EXCEPT AS OTHERWISE PROVIDED IN THIS WARRANTY STATEMENT. BLOMBERG ASSUMES NO RESPONSIBILITY THAT THE PRODUCT WILL BE FIT FOR ANY PARTICULAR PURPOSE FOR WHICH YOU MAY BE BUYING THIS PRODUCT, EXCEPT AS OTHERWISE PROVIDED IN THIS WARRANTY STATEMENT.

Blomberg does not assume any responsibility for incidental or consequential damages. Such damages include, but are not limited to, loss of profits, loss of savings or revenue, loss of use of the cooker or any associated equipment, cost of capital, cost of any substitute equipment, facilities or services, downtime, the claims of third parties, and injury to property. Some states do not allow the exclusion or limitation of incidental or consequential damages, so the above limitations or exclusion may not apply to you.

\* installation date shall refer to either purchase date or 5 business days after delivery of the product to the home, whichever is later.

++Parts replaced will assume the identity of the original parts + their original warranty.

No Other Warranties. This Warranty Statement is the complete and exclusive warranty from the manufacturer. No employee of Blomberg or any other party is authorized to make any warranty statements in addition to those made in this Warranty Statement.

Please keep this warranty card, user manual and your sales slip for future reference.

#### HOW TO GET SERVICE

Please contact the Distributor for your State or Province as listed on the Distributor Contact List, or call our Toll Free Number at 1 800 459 9848 for direction to an Authorized Blomberg Service Agent. 

