

# Technical Data Sheet

**Model:** AB-252A  
**Description:** Solar powered ventilation fan; unit mounted PV panel; self-flashing housing; powder coated finish  
**Revision:** 2  
**Date:** 24-Apr-10  
**DCN:** TDS-1013

Top View

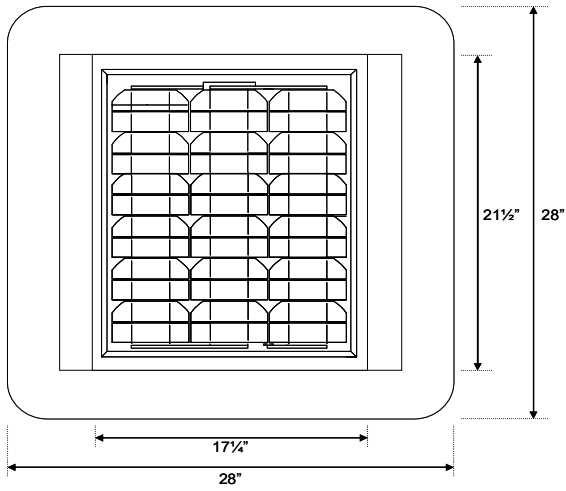

Bottom View

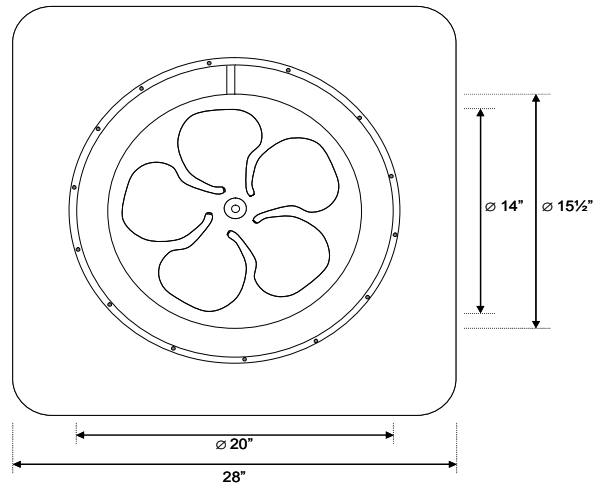

Front View

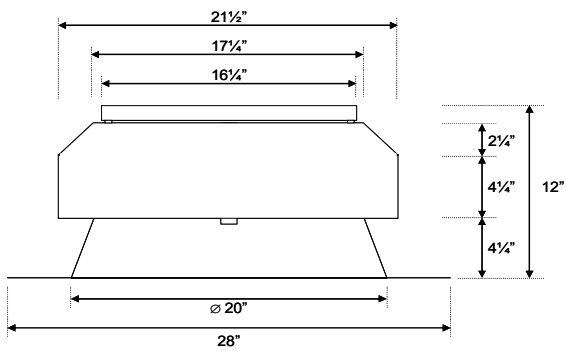

Side View

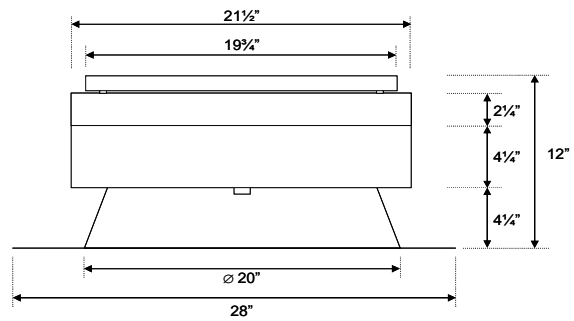

# Model AB-252A Specifications

## **Material of Construction**

Fan Housing: 24 GA Zincolume (ASTM A792 - 55% Aluminum-Zinc Alloy Coated by Hot-Dip Process)  
Rodent Screen: 1/4" Mesh Stainless Steel Screen  
Fan Blade: Proprietary 14" 5-Wing Aluminum Blade with Integrated Balanced Hub  
PV Panel: Anodized Aluminum Frame with Impact Resistant Tempered Glass  
Finish: Powder Coated; TGIC polyester coating; 3-6 mils average thickness  
Hardware: Stainless Steel Brackets & Fasteners

## **Electrical**

Motor: Proprietary 38 V variable speed DC motor  
PV Panel: Proprietary 25 W monocrystalline panel, 36 cells  
Internal Wiring: 18 AWG  
Remote Cable: N/A  
Termination: UV/Weather Resistant Quick Disconnect Plugs

## **Performance**

Air Movement: 1550 CFM @ 0.0 inH<sub>2</sub>O  
Noise Level: < 1 sones (< 30 dB)  
Wind Rating: +115 PSF/-115 PSF; +170 MPH Wind Speed Equivalence\*; Florida Approval #FL13339.1

## **Weight Load**

Fan Unit: 28 LBS  
Remote Panel: N/A

\* Wind speed equivalence based on 30 foot mean roof height in Exposure B; wind zones 1-3; all roof pitches apply

