

Aston Bromley SEN967-4228

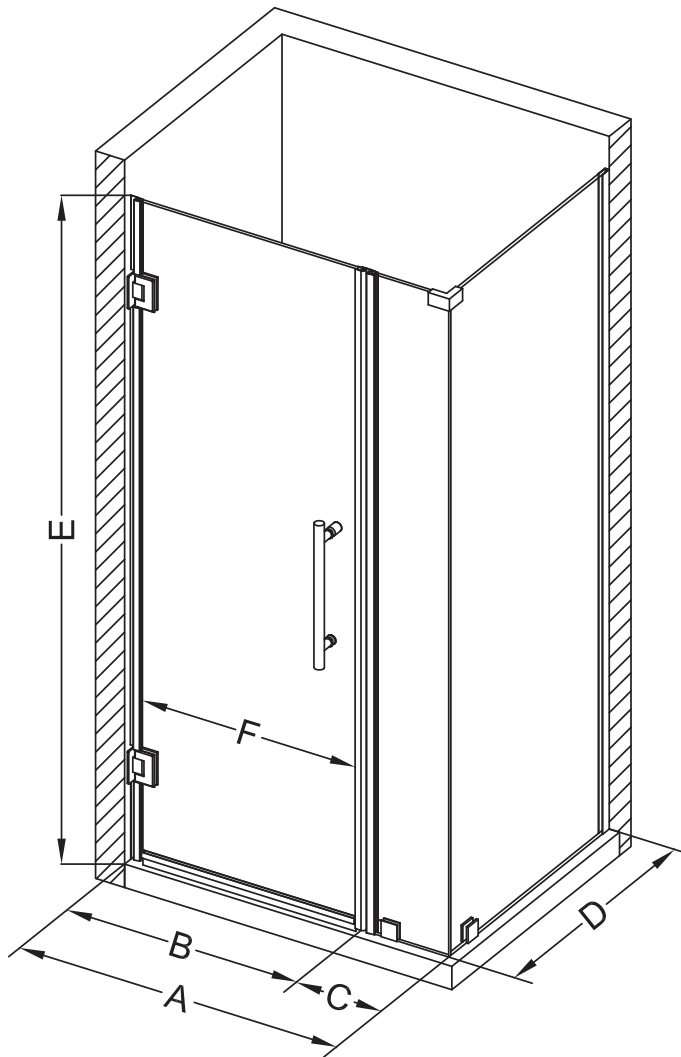

MODEL	WALL OPENING (A)	DOOR PANEL (B)	FIXED PANEL (C)	RETURN PANEL (D)	HEIGHT (E)	DOOR WALK THROUGH (F)
SEN967-422830-10	41 1/4"-42 1/4"	27 5/8"	13 5/8"	30"-30 3/8"	72"	25 5/8"-26 5/8"
SEN967-422832-10	41 1/4"-42 1/4"	27 5/8"	13 5/8"	32"-32 3/8"	72"	25 5/8"-26 5/8"
SEN967-422834-10	41 1/4"-42 1/4"	27 5/8"	13 5/8"	34"-34 3/8"	72"	25 5/8"-26 5/8"
SEN967-422836-10	41 1/4"-42 1/4"	27 5/8"	13 5/8"	36"-36 3/8"	72"	25 5/8"-26 5/8"
SEN967-422838-10	41 1/4"-42 1/4"	27 5/8"	13 5/8"	38"-38 3/8"	72"	25 5/8"-26 5/8"

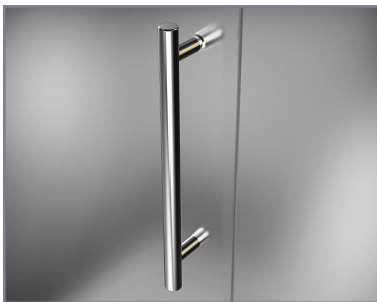

POLISHED CHROME



STAINLESS STEEL

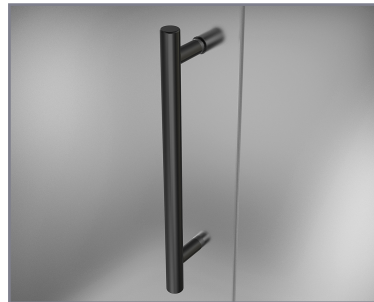

OIL RUBBED BRONZE



CLEAR GLASS



CH CHROME HARDWARE

SS STAINLESS STEEL HARDWARE

ORB OIL RUBBED BRONZE HARDWARE



REVERSIBLE DOOR

ASTON
STARCAST
FROM **EnduroShield**

ASTON
ESCAPE THE EVERYDAY