

American Standard

**Supplemental
Installation Instructions for
Steel Baths
Models 0153 & 0155**

1. Prepare Proper Rough In Opening.

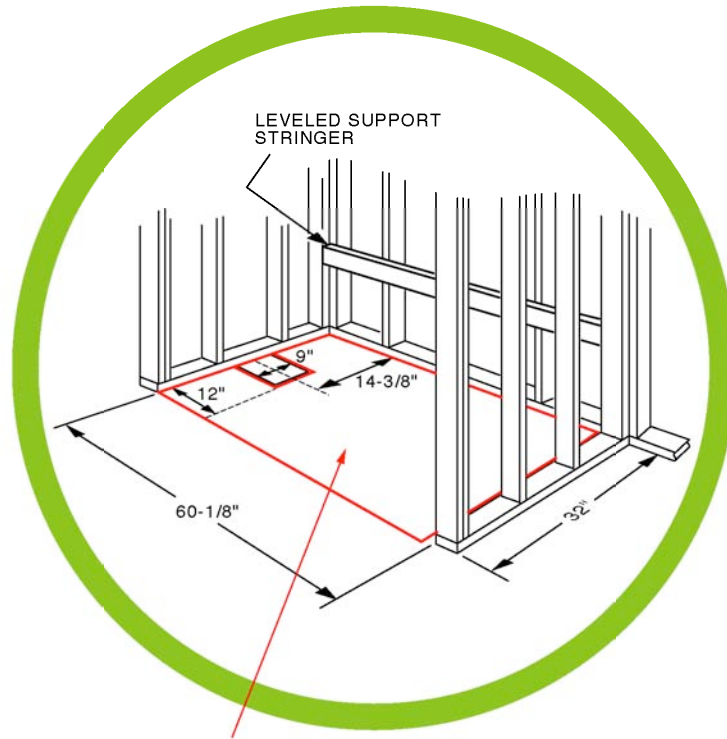

2. Make Sure Floor Is Level

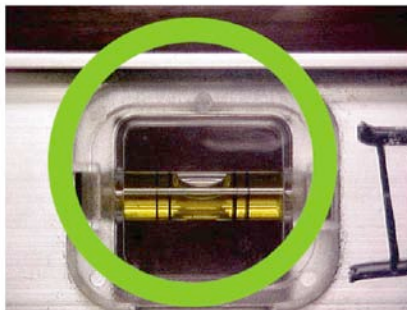

American Standard

Steel Baths Models 0153 & 0155

3. Do Not Cement Drain In Place.



Drain assembly well.

• **NOTE:** See **STEP 12**

4. Use The Proper - Full Length - Support Stringer.

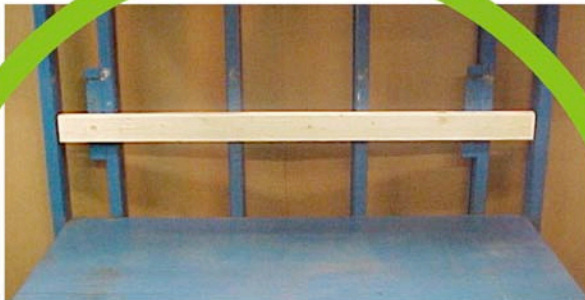

2"x4"

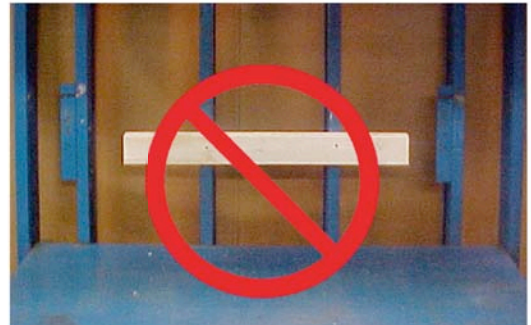

1"x2"



4"x4"

American Standard

Steel Baths Models 0153 & 0155

5. Install Level Support Stringer At Proper Height.

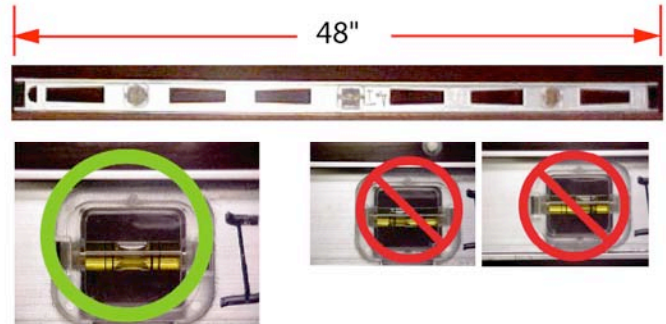
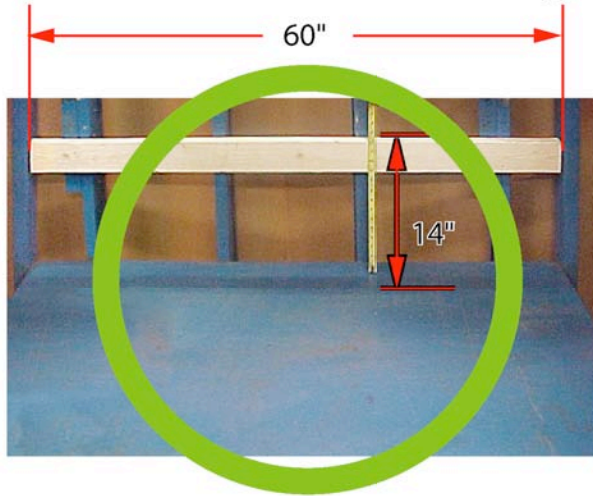

6. Securely fasten the stringer to the studs.

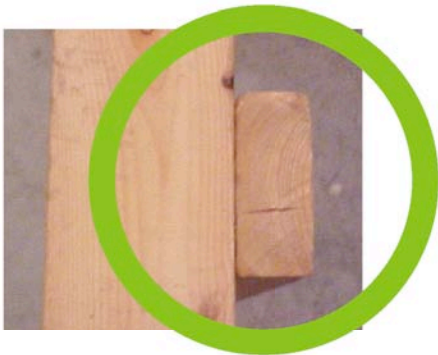

7. Use appropriate screws when attaching the stringer to a metal stud.

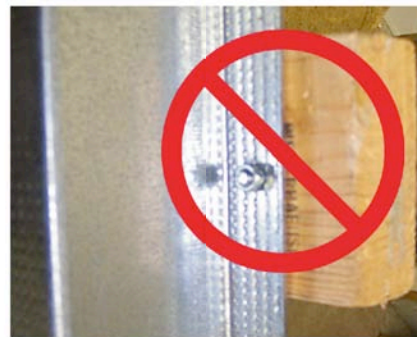
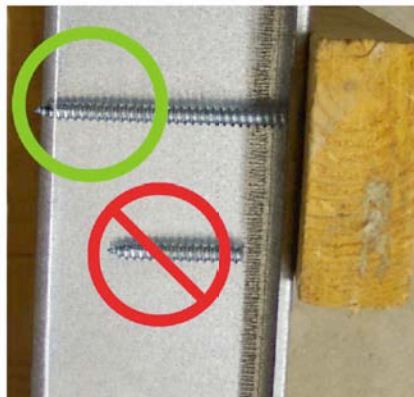

American Standard

Steel Baths Models 0153 & 0155

8. Inspect Tub Prior To Installation.



9. Install Overflow And Drain Assembly Per Manufacturer's Instructions.
Use Plumber's Putty On Drain (A) To Ensure A Watertight Seal.

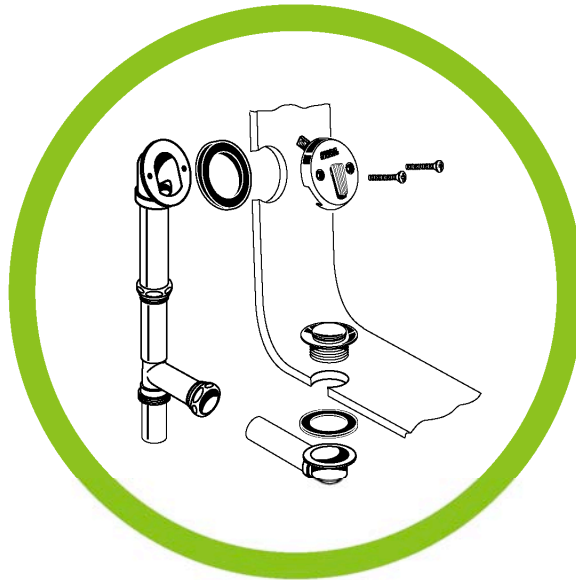

10. Do Not Remove The Styrofoam Pad.



American Standard

Steel Baths Models 0153 & 0155

10. Do Not Use Bedding Material Or Try To Flow Skim Coat Under Tub.



11. Make Sure Installed Tub Is Level.

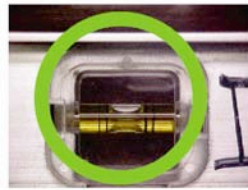
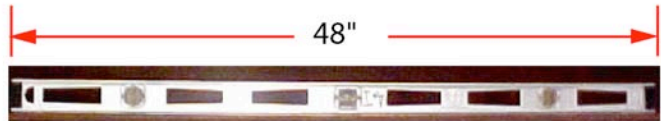
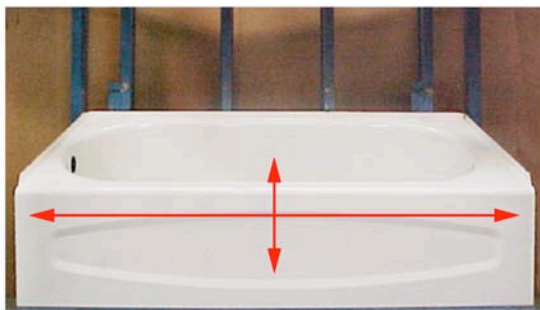

12. Styrofoam Pad Should Be Touching The Floor.

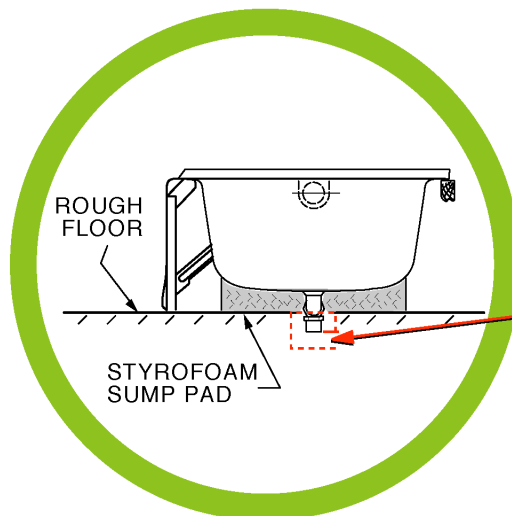

1" minimum clearance from floor of drain well to bottom of Tee.

American Standard

Steel Baths Models 0153 & 0155

13. Properly Secure The Tub In Place.

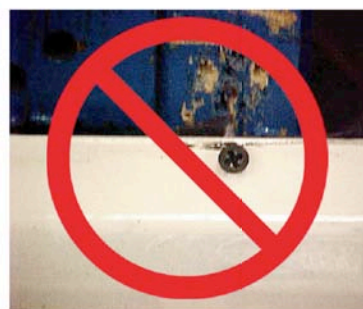
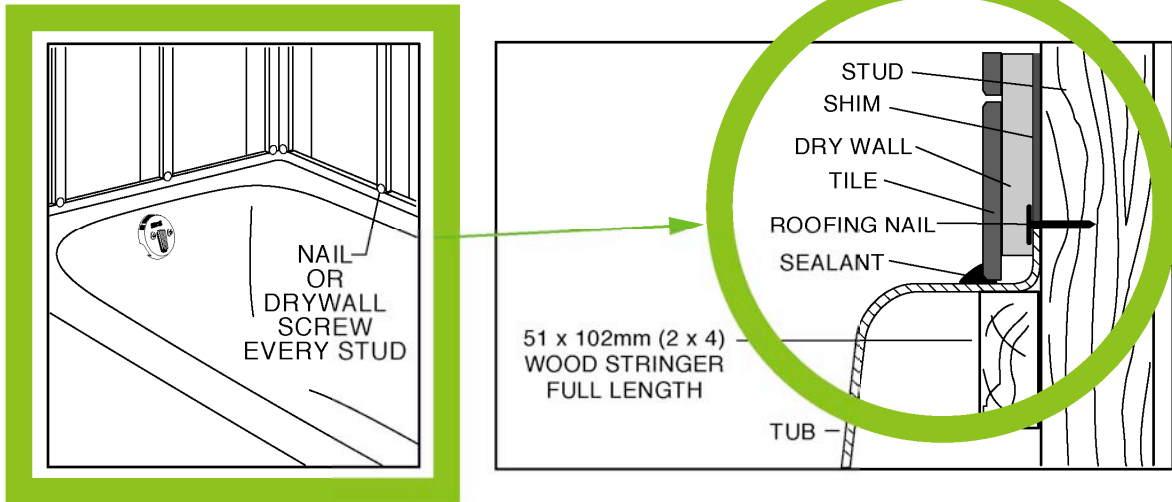

American Standard

Steel Baths Models 0153 & 0155

14. Protect The Tub From Damage.

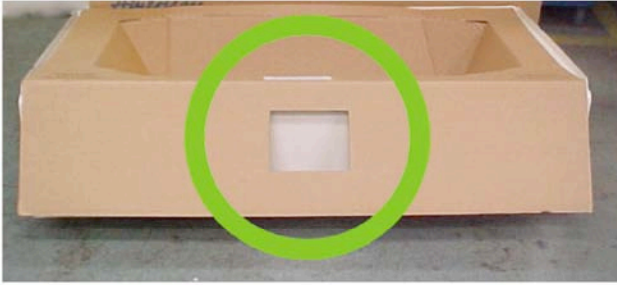

15. Do Not Clean With Abrasives Or Strong Acid.



16. Use Approved Cleaners.



American Standard

Steel Baths Models 0153 & 0155

WARRANTY

AMERICAN-STANDARD ONE-YEAR LIMITED WARRANTY

If inspection of this American-Standard plumbing product, within one year after its initial purchase, confirms that it is defective in materials or workmanship, American-Standard will repair or, at its option, exchange the product for a similar model.

This warranty **does not apply** to local building code compliance. Since local building codes vary considerably, the purchaser of this product should check with a local building or plumbing contractor to insure local code compliance before installation.

This warranty **shall be void** if the product has been moved from its initial place of installation; if it has been subjected to faulty maintenance, abuse, misuse, accident or other damage; if it was not installed in accordance with American-Standard's instructions; or if it has been modified in a manner inconsistent with the product as shipped by American-Standard.

American-Standard's option to repair or exchange the product under this warranty does not cover any labor or other costs of removal or installation, **nor shall American-Standard be responsible for any other incidental or consequential damages attributable to a product defect or to the repair or exchange of a defective product, all of which are expressly excluded from this warranty.** (Some states or provinces do not allow the exclusion or limitation of implied warranties, so this exclusion may not apply to you.)

This warranty gives you specific legal rights. You may have other statutory rights that vary from state to state or from province to province, in which case this warranty does not affect such statutory rights.

For service under this warranty, it is suggested that a claim be made through the contractor or dealer from or through whom the product was purchased, or that a service request (including a description of the product model and of the defect) be sent to the following address:

In the United States:

American Standard Inc.,
P.O. Box 6820
Piscataway, New Jersey 08855
Attention: Director of Consumer Affairs

In Canada:

American-Standard,
2480 Stanfield Rd.,
Mississauga, Ontario
Canada L4Y 1S2
Toll free: (800) 387-0369

In Mexico:

Customer Service Manager
Ideal Standard, S. A. de C.V.
Via Morelos #330
Col. Santa Clara
Ecatepec 55540 Edo. Mexico

For residents of the United States, warranty information may also be obtained by calling the following toll free number: (800) 442-1902

*American
Standard*

*Ideal
Standard*

*Inessa
Standard*

*Sadona
Standard*

Cedexa

Saniwares

© American Standard Inc. 2004

791116-100 Rev. F