

## **PRODUCT DIMENSIONS**

<b>STUDIO 5' x 32"</b>	<b>MODEL 2932</b>
<b>STUDIO 5' x 32" with Tile Flange</b>	<b>MODEL 2933</b>
<b>STUDIO 5' x 36"</b>	<b>MODEL 2934</b>
<b>STUDIO 5' x 36" with Tile Flange</b>	<b>MODEL 2935</b>
<b>STUDIO 5-1/2' x 36"</b>	<b>MODEL 2938</b>
<b>STUDIO 5-1/2' x 36" with Tile Flange</b>	<b>MODEL 2939</b>
<b>STUDIO 6' x 36"</b>	<b>MODEL 2940</b>
<b>STUDIO 6' x 36" with Tile Flange</b>	<b>MODEL 2941</b>
<b>STUDIO 6' x 42"</b>	<b>MODEL 2942</b>
<b>STUDIO 6' x 42" with Tile Flange</b>	<b>MODEL 2943</b>
<b>STUDIO CORNER</b>	<b>MODEL 2944</b>

**SPECIFICATIONS:**

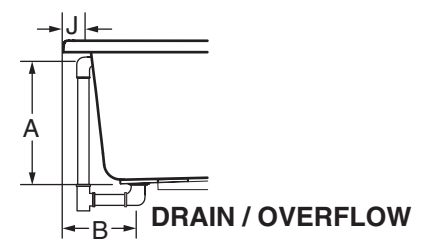
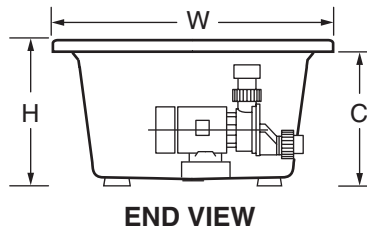
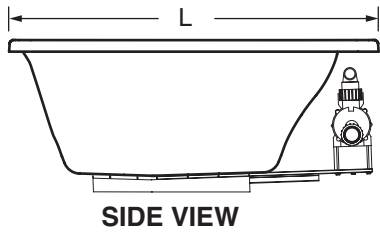

**GENERAL SPECIFICATIONS FOR STUDIO 5' X 32" WHIRLPOOLS AND BATH TUBS**

Description	Deck Trim Option	Dimensions L-W-H	Drain / Overflow	Height to Underside of Deck: C	Cut Out Pier G x F	Rough-In Recess E x D	Tub Edge to Centerline Overflow: J	Weight with Water / Floor Loading	Product Weight	Gallon to Overflow	Whirlpool Operating Volume
2932 Studio 5' x 32"	Zero (5/8")	L 59-1/2" (1511mm) W 31-1/2" (800mm) H 22-1/2" (572mm)	A 17-3/4" (451mm) B 10-3/4" (273mm)	C 21-7/8" (556mm)	58" (1473mm) x 30" (762mm)	59-11/16" (1516mm) x 30" (762mm)		581 lb. (264 kg)/ 44 lb./sq.ft. (213 kg/sq.m)	90 lb. (198 kg.)	59 gal. (224 l.)	54 gal. (205 l.)
2932 Studio 5' x 32"	2"	L 59-3/4" (1518mm) W 31-3/4" (806mm) H 22-1/2" (572mm)	A 17-3/4" (451mm) B 10-7/8" (276mm)	C 20-1/2" (521mm)	58-1/4" (1480mm) x 30-1/4" (768mm)	59-15/16" (1522mm) x 30-1/4" (768mm)		581 lb. (264 kg)/ 44 lb./sq.ft. (213 kg/sq.m)	90 lb. (198 kg.)	59 gal. (224 l.)	54 gal. (205 l.)
2932 Studio 5' x 32"	4"	L 60" (1524mm) W 32" (813mm) H 22-1/2" (572mm)	A 17-3/4" (451mm) B 11" (279mm)	18-1/2" (470mm)	58-1/2" (1486mm) x 30-1/2" (775mm)	60-3/16" (1529mm) x 30-1/2" (775mm)		581 lb. (264 kg)/ 44 lb./sq.ft. (213 kg/sq.m)	90 lb. (198 kg.)	59 gal. (224 l.)	54 gal. (205 l.)
2933 Studio 5' x 32" w/Tile Flange	N/A	L 60" (1524mm) W 31-7/8" (810mm) H 22-1/2" (572mm)	A 17-3/4" (451mm) B 11" (279mm)	C 20-1/2" (521mm)	N/A	60-3/16" (1529mm) x 30-3/8" (772mm)		581 lb. (264 kg)/ 44 lb./sq.ft. (213 kg/sq.m)	90 lb. (198 kg.)	59 gal. (224 l.)	54 gal. (205 l.)

**TABLE 2**

**ROUGH-IN REFERENCES  
MODEL SERIES 2932 & 2933**

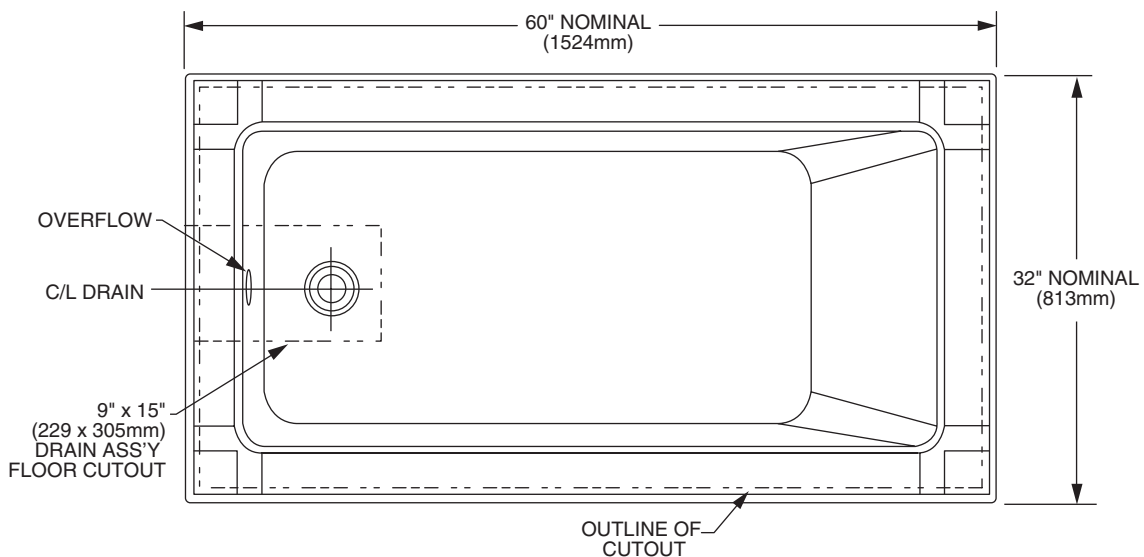

**SPECIFICATIONS:**

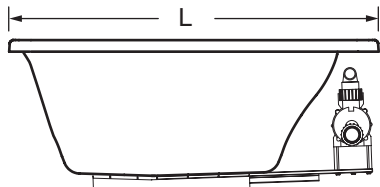

**SIDE VIEW**

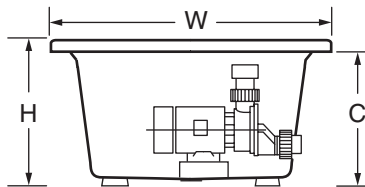

**END VIEW**

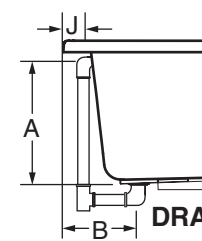

**DRAIN / OVERFLOW**

**GENERAL SPECIFICATIONS FOR STUDIO 5' X 36" WHIRLPOOLS AND BATH TUBS**

Description	Deck Trim Option	Dimensions L-W-H	Drain / Overflow	Height to Underside of Deck: C	Cut Out Pier G x F	Rough-In Recess E x D	Tub Edge to Centerline Overflow: J	Weight with Water / Floor Loading	Product Weight	Gallon to Overflow	Whirlpool Operating Volume
2934 Studio 5' x 36"	Zero (5/8")	L 59-1/2" (1511mm) W 35-1/2" (902mm) H 22-1/2" (572mm)	A 17-3/4" (451mm) B 10-3/4" (273mm)	C 21-7/8" (556mm)	58" (1473mm) x 34" (864mm)	59-11/16" (1516mm) x 34" (864mm)		686 lb. (311 kg)/ 46 lb./sq.ft. (223 kg/sq.m)	95 lb. (209 kg.)	71 gal. (269 l.)	64 gal. (243 l.)
2934 Studio 5' x 36"	2"	L 59-3/4" (1518mm) W 35-3/4" (908mm) H 22-1/2" (572mm)	A 17-3/4" (451mm) B 10-7/8" (276mm)	C 20-1/2" (521mm)	58-1/4" (1480mm) x 34-1/4" (870mm)	59-15/16" (1522mm) x 34-1/4" (870mm)		686 lb. (311 kg)/ 46 lb./sq.ft. (223 kg/sq.m)	95 lb. (209 kg.)	71 gal. (269 l.)	64 gal. (243 l.)
2934 Studio 5' x 36"	4"	L 60" (1524mm) W 36" (914mm) H 22-1/2" (572mm)	A 17-3/4" (451mm) B 11" (279mm)	18-1/2" (470mm)	58-1/2" (1486mm) x 34-1/2" (876mm)	60-3/16" (1529mm) x 34-1/2" (876mm)		686 lb. (311 kg)/ 46 lb./sq.ft. (223 kg/sq.m)	95 lb. (209 kg.)	71 gal. (269 l.)	64 gal. (243 l.)
2935 Studio 5' x 36" w/Tile Flange	N/A	L 60" (1524mm) W 35-7/8" (911mm) H 22-1/2" (572mm)	A 17-3/4" (451mm) B 11" (279mm)	C 20-1/2" (521mm)	N/A	60-3/16" (1529mm) x 34-3/8" (873mm)		686 lb. (311 kg)/ 46 lb./sq.ft. (223 kg/sq.m)	95 lb. (209 kg.)	71 gal. (269 l.)	64 gal. (243 l.)

**TABLE 3**

**ROUGH-IN REFERENCES  
MODEL SERIES 2934 & 2935**

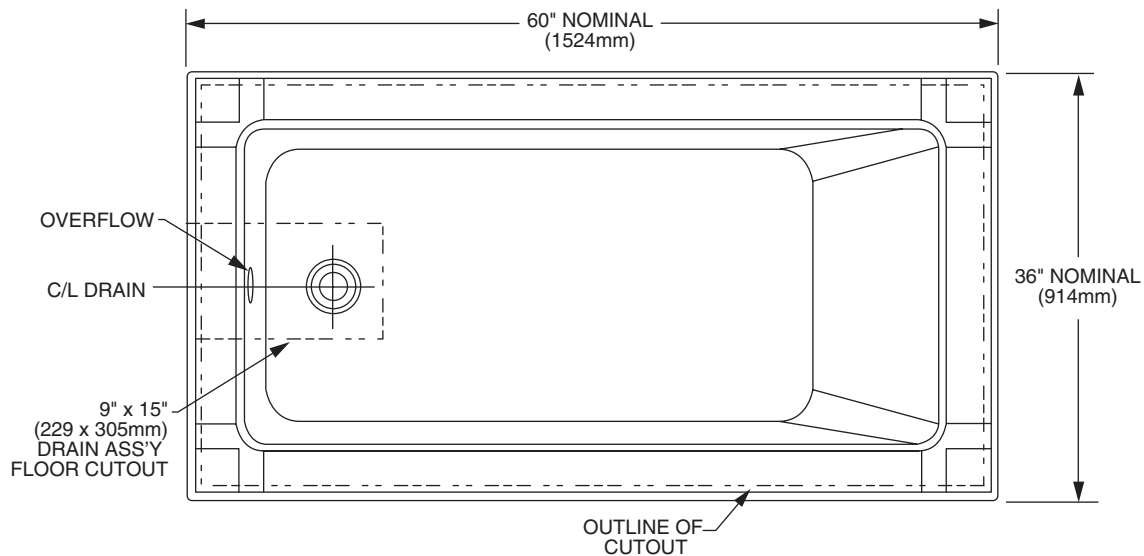

**SPECIFICATIONS:**

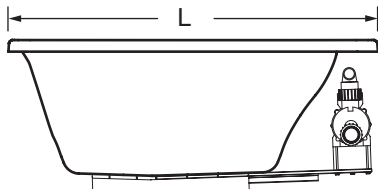

**SIDE VIEW**

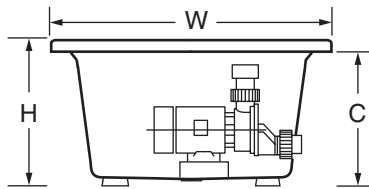

**END VIEW**

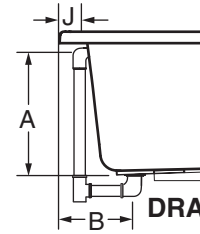

**DRAIN / OVERFLOW**

**GENERAL SPECIFICATIONS FOR STUDIO 5-1/2' X 36" WHIRLPOOLS AND BATH TUBS**

Description	Deck Trim Option	Dimensions L-W-H	Drain / Overflow	Height to Underside of Deck: C	Cut Out Pier G x F	Rough-In Recess E x D	Tub Edge to Centerline Overflow: J	Weight with Water / Floor Loading	Product Weight	Gallon to Overflow	Whirlpool Operating Volume
2938 Studio 5-1/2' x 36"	Zero (5/8")	L 65-1/2" (1664mm) W 35-1/2" (902mm) H 22-1/2" (572mm)	A 17-3/4" (451mm) B 10-3/4" (273mm)	C 21-7/8" (556mm)	64" (1626mm) x 34" (864mm)	65-11/16" (1668mm) x 34" (864mm)		766 lb. (348 kg)/ 46 lb./sq.ft. (227 kg/sq.m)	100 lb. (220 kg.)	80 gal. (303 l.)	73 gal. (277 l.)
2938 Studio 5-1/2' x 36"	2"	L 65-3/4" (1670mm) W 35-3/4" (908mm) H 22-1/2" (572mm)	A 17-3/4" (451mm) B 10-7/8" (276mm)	C 20-1/2" (521mm)	64-1/4" (1632mm) x 34-1/4" (870mm)	65-15/16" (1675mm) x 34-1/4" (870mm)		766 lb. (348 kg)/ 46 lb./sq.ft. (227 kg/sq.m)	100 lb. (220 kg.)	80 gal. (303 l.)	73 gal. (277 l.)
2938 Studio 5-1/2' x 36"	4"	L 66" (1676mm) W 36" (914mm) H 22-1/2" (572mm)	A 17-3/4" (451mm) B 11" (279mm)	18-1/2" (470mm)	64-1/2" (1638mm) x 34-1/2" (876mm)	66-3/16" (1681mm) x 34-1/2" (876mm)		766 lb. (348 kg)/ 46 lb./sq.ft. (227 kg/sq.m)	100 lb. (220 kg.)	80 gal. (303 l.)	73 gal. (277 l.)
2939 Studio 5-1/2' x 36" w/Tile Flange	N/A	L 66" (1676mm) W 35-7/8" (911mm) H 22-1/2" (572mm)	A 17-3/4" (451mm) B 11" (279mm)	C 20-1/2" (521mm)	N/A	66-3/16" (1681mm) x 34-3/8" (873mm)		766 lb. (348 kg)/ 46 lb./sq.ft. (227 kg/sq.m)	100 lb. (220 kg.)	80 gal. (303 l.)	73 gal. (277 l.)

**TABLE 4**

**ROUGH-IN REFERENCES  
MODEL SERIES 2938 & 2939**

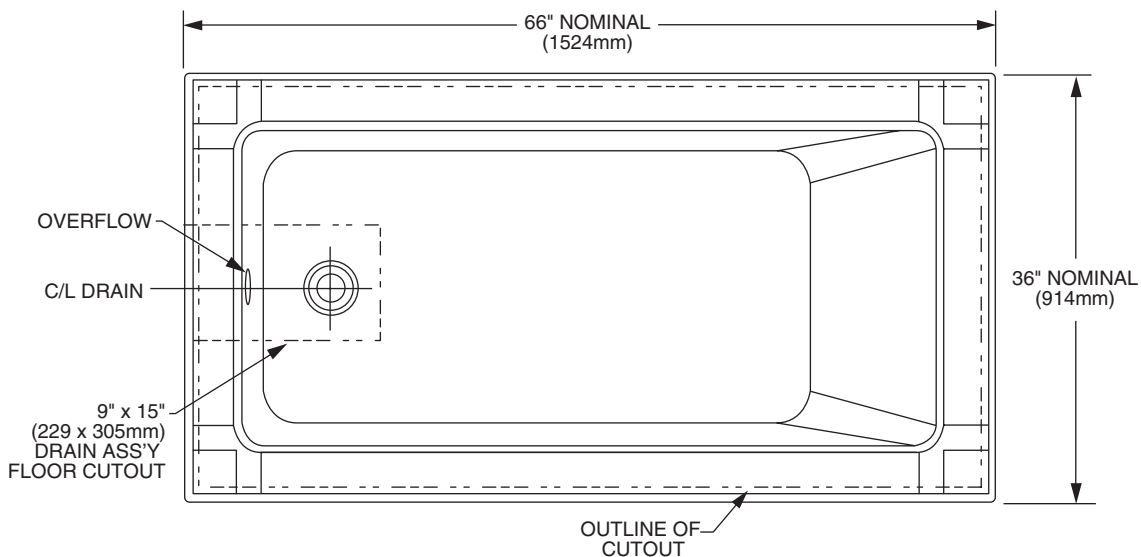

**SPECIFICATIONS:**

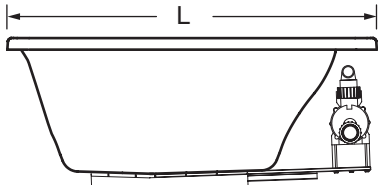

**SIDE VIEW**

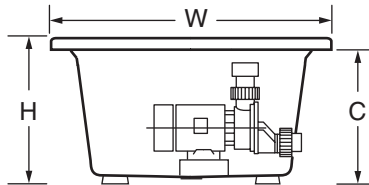

**END VIEW**

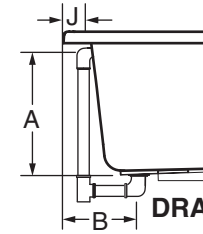

**DRAIN / OVERFLOW**

**GENERAL SPECIFICATIONS FOR STUDIO 6' X 36" WHIRLPOOLS AND BATH TUBS**

Description	Deck Trim Option	Dimensions L-W-H	Drain / Overflow	Height to Underside of Deck: C	Cut Out Pier G x F	Rough-In Recess E x D	Tub Edge to Centerline Overflow: J	Weight with Water / Floor Loading	Product Weight	Gallon to Overflow	Whirlpool Operating Volume
2940 Studio 6' x 36"	Zero (5/8")	L 71-1/2" (1816mm) W 35-1/2" (902mm) H 22-1/2" (572mm)	A 17-3/4" (451mm) B 10-3/4" (273mm)	C 21-7/8" (556mm)	70" (1778mm) x 34" (864mm)	71-11/16" (1821mm) x 34" (864mm)		846 lb. (384 kg)/ 47 lb./sq.ft. (230 kg/sq.m)	105 lb. (231 kg.)	89 gal. (337 l.)	81 gal. (307 l.)
2940 Studio 6' x 36"	2"	L 71-3/4" (1822mm) W 35-3/4" (908mm) H 22-1/2" (572mm)	A 17-3/4" (451mm) B 10-7/8" (276mm)	C 20-1/2" (521mm)	70-1/4" (1784mm) x 34-1/4" (870mm)	71-15/16" (1827mm) x 34-1/4" (870mm)		846 lb. (384 kg)/ 47 lb./sq.ft. (230 kg/sq.m)	105 lb. (231 kg.)	89 gal. (337 l.)	81 gal. (307 l.)
2940 Studio 6' x 36"	4"	L 72" (1829mm) W 36" (914mm) H 22-1/2" (572mm)	A 17-3/4" (451mm) B 11" (279mm)	18-1/2" (470mm)	70-1/2" (1791mm) x 34-1/2" (876mm)	72-3/16" (1833mm) x 34-1/2" (876mm)		846 lb. (384 kg)/ 47 lb./sq.ft. (230 kg/sq.m)	105 lb. (231 kg.)	89 gal. (337 l.)	81 gal. (307 l.)
2941 Studio 6' x 36" w/Tile Flange	N/A	L 72" (1829mm) W 35-7/8" (911mm) H 22-1/2" (572mm)	A 17-3/4" (451mm) B 11" (279mm)	C 20-1/2" (521mm)	N/A	72-3/16" (1833mm) x 34-3/8" (873mm)		846 lb. (384 kg)/ 47 lb./sq.ft. (230 kg/sq.m)	105 lb. (231 kg.)	89 gal. (337 l.)	81 gal. (307 l.)

**TABLE 5**

**ROUGH-IN REFERENCES  
MODEL SERIES 2940 & 2941**

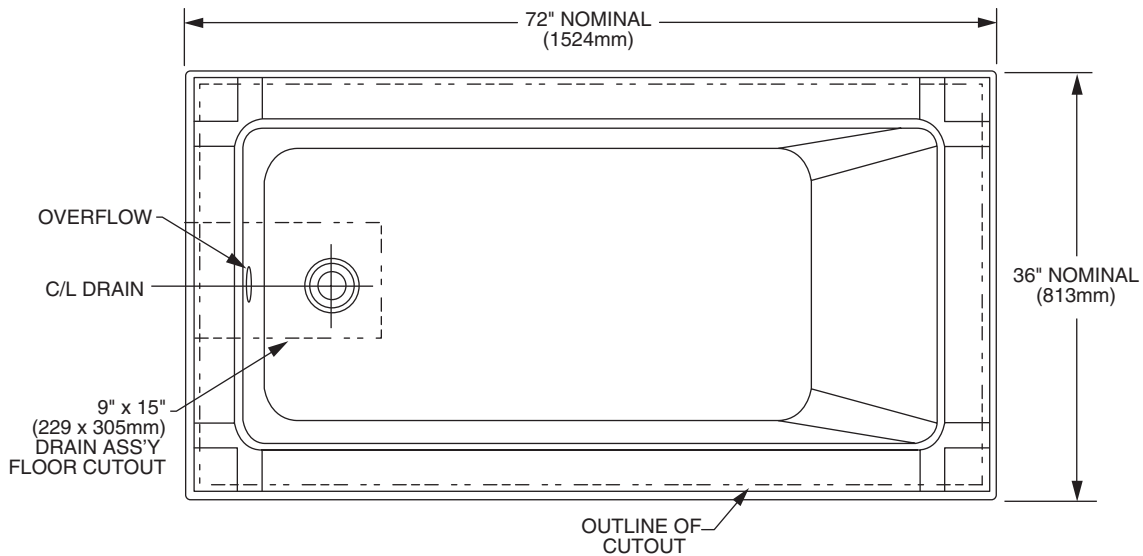

**SPECIFICATIONS:**

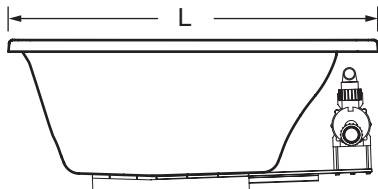

**SIDE VIEW**

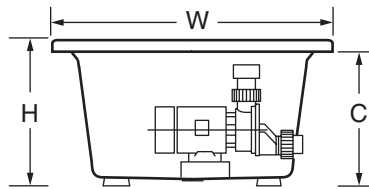

**END VIEW**

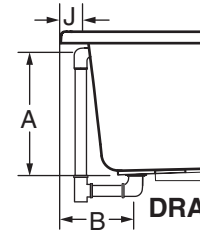

**DRAIN / OVERFLOW**

**GENERAL SPECIFICATIONS FOR STUDIO 6' X 42" WHIRLPOOLS AND BATH TUBS**

Description	Deck Trim Option	Dimensions L-W-H	Drain / Overflow	Height to Underside of Deck: C	Cut Out Pier G x F	Rough-In Recess E x D	Tub Edge to Centerline Overflow: J	Weight with Water / Floor Loading	Product Weight	Gallon to Overflow	Whirlpool Operating Volume
2942 Studio 6' x 42"	Zero (5/8")	L 71-1/2" (1816mm) W 41-1/2" (1054mm) H 22-1/2" (572mm)	A 17-3/4" (451mm) B 10-3/4" (273mm)	C 21-7/8" (556mm)	70" (1778mm) x 40" (1016mm)	71-11/16" (1821mm) x 40" (1016mm)		943 lb. (428 kg)/ 45 lb./sq.ft. (219 kg/sq.m)	110 lb. (242 kg.)	100 gal. (379 l.)	91 gal. (345 l.)
2942 Studio 6' x 42"	2"	L 71-3/4" (1822mm) W 41-3/4" (1060mm) H 22-1/2" (572mm)	A 17-3/4" (451mm) B 10-7/8" (276mm)	C 20-1/2" (521mm)	70-1/4" (1784mm) x 40-1/4" (1022mm)	71-15/16" (1827mm) x 40-1/4" (1022mm)		943 lb. (428 kg)/ 45 lb./sq.ft. (219 kg/sq.m)	110 lb. (242 kg.)	100 gal. (379 l.)	91 gal. (345 l.)
2942 Studio 6' x 42"	4"	L 72" (1829mm) W 42" (1067mm) H 22-1/2" (572mm)	A 17-3/4" (451mm) B 11" (279mm)	18-1/2" (470mm)	70-1/2" (1791mm) x 40-1/2" (1029mm)	72-3/16" (1833mm) x 40-1/2" (1029mm)		943 lb. (428 kg)/ 45 lb./sq.ft. (219 kg/sq.m)	110 lb. (242 kg.)	100 gal. (379 l.)	91 gal. (345 l.)
2943 Studio 6' x 42" w/Tile Flange	N/A	L 72" (1829mm) W 41-7/8" (1063mm) H 22-1/2" (572mm)	A 17-3/4" (451mm) B 11" (279mm)	C 20-1/2" (521mm)	N/A	72-3/16" (1833mm) x 40-3/8" (1026mm)		943 lb. (428 kg)/ 45 lb./sq.ft. (219 kg/sq.m)	110 lb. (242 kg.)	100 gal. (379 l.)	91 gal. (345 l.)

**TABLE 6**

**ROUGH-IN REFERENCES  
MODEL SERIES 2942 & 2943**

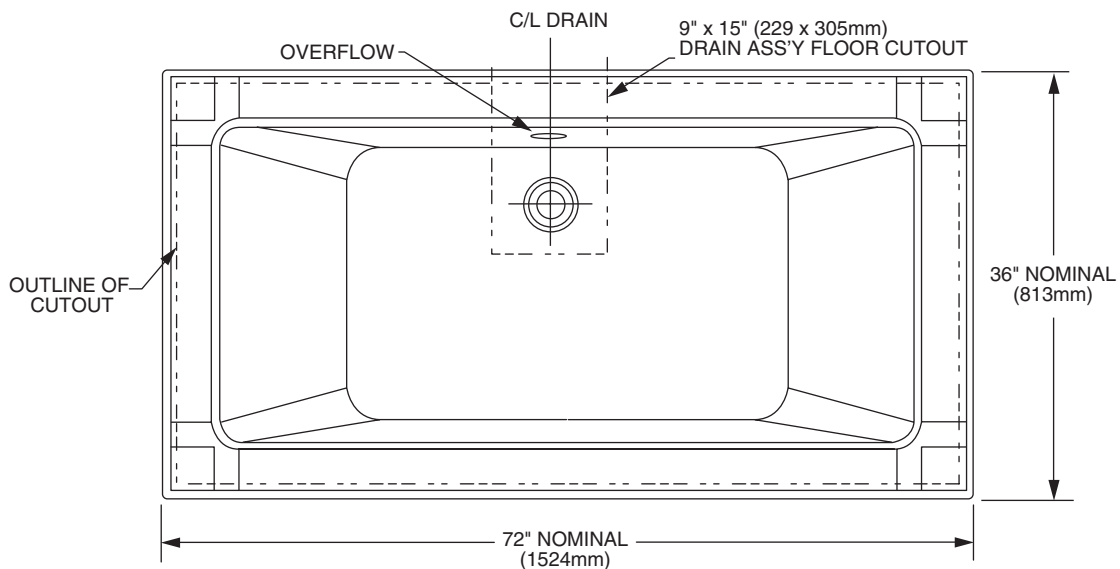

**SPECIFICATIONS:**

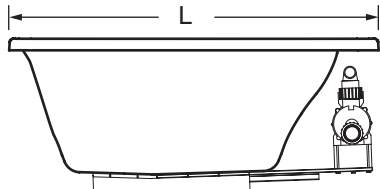

**SIDE VIEW**

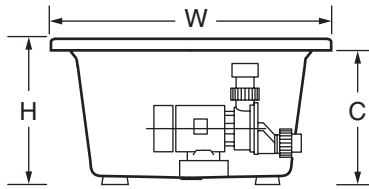

**END VIEW**

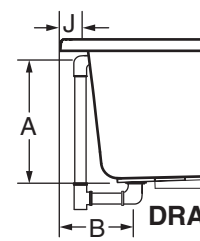

**DRAIN / OVERFLOW**

**GENERAL SPECIFICATIONS FOR STUDIO CORNER WHIRLPOOLS AND BATH TUBS**

Description	Deck Trim	Dimensions L-W-H	Drain / Overflow	Height to Underside of Deck: C	Cut Out Pier G x F	Rough-In Recess E x D	Tub Edge to Centerline Overflow: J	Weight with Water / Floor Loading	Product Weight	Gallon to Overflow	Whirlpool Operating Volume
2944 Studio Corner	Zero (5/8")	L 83-15/16" (2132mm) W 61-3/8" (1559mm) H 21-1/2" (546mm)	A 15" (381mm) B 13-1/2" (343mm)	C 20-7/8" (530mm)		N/A		988 lb. (448 kg)/ 27 lb./sq.ft. (133 kg/sq.m)	130 lb. (59 kg.)	103 gal. (390 l.)	65 gal. (246 l.)
2944 Studio Corner	2"	L 84-1/4" (2139mm) W 31-13/16" (808mm) H 21-1/2" (546mm)	A 15" (381mm) B 13-5/8" (346mm)	C 19-1/2" (495mm)		N/A		988 lb. (448 kg)/ 27 lb./sq.ft. (133 kg/sq.m)	130 lb. (59 kg.)	103 gal. (390 l.)	65 gal. (246 l.)

**TABLE 7**

**ROUGH-IN REFERENCES  
MODEL SERIES 2944**

