

Full Access to Seat for Easy Transfer

Providing a safe and comfortable way for adults to bathe, the watertight door swings outward providing more room when entering and exiting the bath. It also allows for immediate access to the bather in the event of a medical emergency, plus offers the bather full access to the chair height seat for trouble-free transfer from a wheelchair.

MODEL 3252OD.708

- High quality gelcoat with fiberglass reinforcement
- 32" wide x 52" long x 40" high
- Operating capacity: 80 gallons
- Color: white or linen
- Left hand or right hand door & drain

BUILT-IN FEATURES

- Large outward opening tub door
- Built-in chair height seat
- Polished chrome safety bar
- Polished chrome cable driven drain
- Textured tub floor
- Premium tub filler faucet included
- Extension kit to fit into 60" space
- Whirlpool heater
- Lifetime warranty on door seal; 10 years on the tub shell; 5 years on components



Quick Drain® Optional

Our exclusive Quick Drain® technology empties tub in less than two minutes and requires no additional plumbing. Spend less time waiting with this patented innovation.



Whirlpool

Enjoy therapeutic benefits of deep massage



Air Spa

A gentle effervescent experience



Combination

Combines both Air Spa and Whirlpool systems for a full in-home spa experience

Walk-In Bath

www.americanstandard-us.com/safe-and-accessible

3252 Outward Opening Door Value Series



OUTWARD OPENING DOOR 32" x 52" WALK-IN BATH SOAKING TUB, AIR SPA & WHIRLPOOL

3252OD.708.SXX-PC Soaking Tub

- Premium gelcoat construction
- Free standing metal support frame with five adjustable leveling feet
- Easy access outward opening door system
- Contoured, built-in seat for easy transfer
- Built-in grab bar and textured tub floor
- Premium deck-mounted tub filler faucet with hand shower
- Polished chrome cable driven drain assembly
- Extension kit to fit into 60" space

3252OD.708.WXX-PC Whirlpool System

- Easy touch push button control
- In-line whirlpool heater
- 5.5 amp pump
- 6 fully adjustable and directional massage jets

3252OD.708.AXX-PC Air Spa System

- Easy touch push button control
- Heated blower
- 21 seat and floor air injectors
- Automatic purge cycle

3252OD.708.CXX-PC Combination System

- Combines Whirlpool and Air Spa System

Nominal Dimensions:

32" x 52" x 40"
(813 x 1321 x 1016mm)

Compliance Certifications -

Meets or Exceeds the Following Specifications:

- ETL - INTERTEK SEMKO
- IAPMO - USPC
- ANSI Z 124.1.2 - for Plastic Bathtubs
- ASME A112.19.7 - Whirlpool Appliances
- ASME A112.19.15 - for Walk-In Bathtubs
- CSA B-45.5 - Canadian Plumbing Fixtures

To Be Specified - Required:

- Drain Configuration: Left (L) or Right (R)
- Color: White (W) or Linen (L)
- Chromatherapy: 9CTP
- Neck Rest: 9NR
- Handshower Glide Bar: 9HSB
- 24 inch Grab Bar: 9GB-24

* **Note:** The whirlpool heater is designed to maintain water temperature during operation. It will not heat cold water to desired bathing temperature.

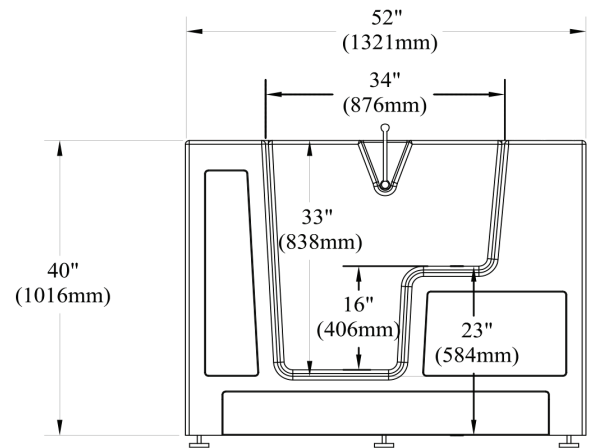
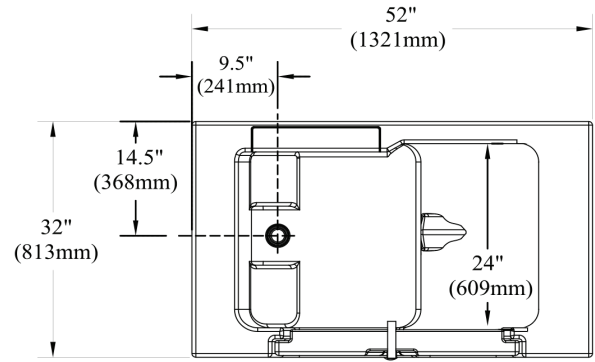

GENERAL SPECIFICATIONS FOR 3252OD.708.XXX-PC WALK-IN BATHTUB WITH OUTWARD OPENING DOOR

INSTALLED SIZE	_____	52x32x40In. (1321x813x1016mm)
WEIGHT	_____	161 Lbs. (73 Kg.)
WEIGHT w/WATER	_____	828 Lbs. (376 Kg.)
OPERATING GALLON	_____	80 Gal. (303L.)
FLOOR LOADING (PROJECTED AREA)	_____	72 Lbs./Sq. Ft. (351 Kgs/Sq. m.)
CUBE (FT ³)	_____	38.5

Notes:

TUB IS SUPPORTED BY THE FRAME AND FIVE INTEGRATED ADJUSTABLE FEET, NO ADDITIONAL SUPPORT REQUIRED.

REFER TO INSTALLATION INSTRUCTIONS SUPPLIED WITH TUB FOR ADDITIONAL INFORMATION.

PROVIDE SUITABLE REINFORCEMENT TO SUB FLOOR FOR ALL SUPPORTS.

IMPORTANT: Dimensions of fixtures are nominal, may vary and are subject to change or cancellation.

No responsibility is assumed for use of superseded or voided leaflet.