

Air King[®]

Ventilation Products

SPECIFICATIONS

AS60

EXHAUST FANS

60 CFM/3.5 SONES @ 0.10" WG. -HVI CERTIFIED
120 Volts, 0.9 amps, 60 hz.

- Grill**
 White, polymeric grill secured in place with torsion springs; easily removed if necessary, dimensions - 10" x 9 1/2".
- Blower Wheel**
 One piece polymeric wheel, 4 1/2" diameter, 1" wide, with 10 fins.
- Motor**
 Single coil plug-in, two pole motor, life time lubrication, thermally protected. Rated 120 volts, 60 hz., 0.9 amps.
- Fan Housing**
 23 gauge galvanized metal housing, dimensions 7 1/4" x 7 1/4" x 3 3/4", double metal thickness mounting tabs.
- Duct Collar**
 Plastic collar for 3" duct connection, comes complete with built in non-metallic back draft damper for quiet operation.
- Ventilating Area**
 For bathrooms up to 60 sq. ft. for other rooms up to 75 sq. ft.
- Unit Mounting**
 Rated for ceilings insulated to R-40. Designed to mount in ceilings or walls with at least 4" of clearance. The housing will mount through drywall thickness up to 3/4", with a rough-in opening of 7 1/2" x 7 1/2".
- Single Pack Shipping Info**
 Box Dim: 10 3/4" x 10 1/8" x 4 3/4"
 UPC: 0-8316226311-7
 Shipping Weight: 4 1/2 lbs.

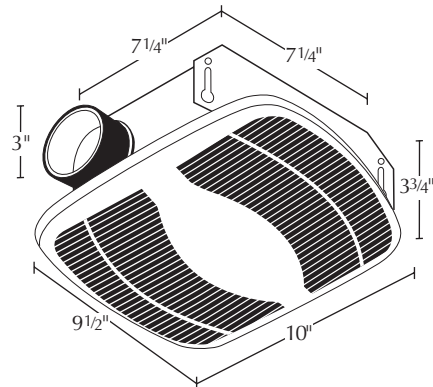

CUL/HVI

Acceptable for use over tub or shower when installed in a GFCI protected branch circuit.

PERFORMANCE

	Static Pressure (inches of w.g.)								HVI Sones @ .1 SP	Fan Speed RPM	Power Watts
	0	0.05	0.1	0.15	0.2	0.25	0.3	0.35			
Air Flow - CFM	67	65	60	55	50	44	30	13	3.5	2600	63

PROJECT					ARCHITECT						
LOCATION					ENGINEER						
CONTRACTOR					SUBMITTED BY					DATE	
FAN NUMBER	MODEL NUMBER	CFM	IN W.G.	RPM	WATTS	AMPS	SONES	QTY	OPTIONAL EQUIPMENT & REMARKS		



U.S.: 820 Lincoln Drive
 West Chester, Pennsylvania 19380-4466
 Tel: (610) 692-7400 • 877-304-3785
 Fax: (610) 696-8048

Canada: 110 Glidden Road
 Brampton, Ontario L6T 2J3
 Tel: (905) 456-2033
 Fax: (905) 456-1015